

# CHALMERS



## Development of Learning Material to Wind Power Courses

Master of Science Thesis of *Electric Power Engineering*

Kristin Bruhn  
Sofia Lorensen  
Jennie Svensson

*Division of Electric Power Engineering*  
Department of Energy and Environment  
CHALMERS UNIVERSITY OF TECHNOLOGY  
Gothenburg, Sweden 2009



Development of Learning Material to Wind Power Courses  
KIRSTIN BRUHN  
SOFIA LORENSSON  
JENNIE SVENSSON

© KRISTIN BRUHN, SOFIA LORENSSON and JENNIE SVENSSON, 2009

Department of Energy and Environment  
Chalmers University of Technology  
SE-412 96 Gothenburg  
Sweden  
Telephone + 46 (0)31-772 1000

Chalmers, TeknologTryck  
Gothenburg, Sweden 2009



## Abstract

Wind power plants are more and more commonly used as power production units, which lead to an increased demand of educated personnel within the area. Today, Sweden produces about 1.4 TWh wind power per year, but Sweden and EU have set goals that will increase the production enormously in the future. Difficulties occur in the education stage of wind power, since the selection of course material is poor. Investigations of wind power courses in Europe showed that Denmark is the leading country in Europe regarding wind power education. In Sweden, University Gotland has the widest range of courses in the area. This master thesis is about developing course material for education in wind power technology. It includes two compendia with appropriate learning material to achieve relevant knowledge. The compendium for upper secondary school has a basic level and is written in Swedish, the one for master students is written in English and includes one basic, and one advanced part with focus on electrical components and how to connect wind power plants to the power grid. To gather information and knowledge of what is appropriate to include in the learning material, meetings and study visits have been arranged. There have been meetings with persons in the wind power business, teachers and people in Power Cluster, a wind power project in EU. Study visits have been done at University Gotland and Vattenfall, located at Näsudden. A visit inside a wind power plant at Hönö has also been done in order to study a nacelle from the inside. The produced material in this project is only a start of the education material development, which is why there are large possibilities to develop it further in the future.

Keywords: Wind energy, wind power education, renewable energy source, power regulation, power quality, Betz law, fixed speed, variable speed



## Acknowledgement

We would like to thank our supervisor and examiner Associate Professor Ola Carlson for his supervision, his support and help with arranging meetings with interesting people we never would have met without him.

We want to thank Åke Larsson, who gave us a lot of inspiration, great stories and information based on work experience.

Magnus Ellsén and Klas Utbult, thank you for helping us out with permissions and the opportunity of the study visit inside the nacelle in the wind power plant on Hönö.

We also want to thank the team from Power Cluster, University Gotland and Vattenfall at Näsudden, Gotland for help with answering many questions and showing us around.

Thank you Abram Perdana for helping us with wind power models in MatLab and Valborg Ekman for your help with travel reservations.

Finally, many thanks to Henrik Boklund, Joakim Ramer, Ann Johansson for giving feedback to the material, and to everyone involved at the division of Electric Power Engineering.

*Kristin, Sofia and Jennie*  
Gothenburg, 2009





**Table of contents**

- 1 Introduction ..... 1**
- 1.1 Background..... 1
- 1.2 Purpose..... 1
- 1.3 Problems..... 1
- 1.4 Delimitation..... 2
  
- 2 Method..... 3**
- 2.1 The writing..... 3
  - 2.1.1 *Compendium for upper secondary school*..... 3
  - 2.1.2 *Compendium for master students* ..... 4
- 2.2 Elaboration ..... 6
  
- 3 Discussion ..... 7**
- 3.1 Conclusion..... 7
- 3.2 Future work..... 8
  
- Appendix A.....
- Appendix B.....
- Appendix C.....
- C-1 .....
- C-2 .....
- C-3 .....



# 1 Introduction

Wind power energy is a rapidly growing industry and a large amount of competent personnel is needed in a near future. Today, difficulties occur already in the education stage regarding wind power, since the selection of course material is poor. This means, not enough students graduate with knowledge in this specific area. Students need to get interested in wind power and have the possibility to choose courses focused on the area. To obtain this, there is a need for new courses and course material, which is the ambition of this master thesis work.

## 1.1 Background

Power Cluster is a project with the purpose of developing offshore wind power in northern Europe in general, mostly in the participating countries. 18 partners from six different countries are involved in the project. Involved countries are Germany, The United Kingdom, Denmark, The Netherlands, Norway and Sweden. The project started late summer 2008 and progress for three years.

The participating countries have different qualifications regarding wind power and various individual strengths and weaknesses within the area. The involved regions have the possibility of exchanging knowledge and capacity. In this way, a strong network is created, which brings together different expertise in order to create more innovation in the sector.

Development of wind power courses is an important part of Power Cluster in order to achieve a strong development of wind power energy. Personnel with appropriate skills and knowledge must be educated and for this appropriate learning material is necessary.

This master thesis, is about developing course material for education in wind power technology. It investigates how to create appropriate learning material to achieve relevant knowledge.

## 1.2 Purpose

Wind power plants are used more often as power production units, which lead to a larger demand of educated personnel within the area. To obtain people wanting to take courses considering wind power, it is desirable to create fascination for the subject for students in early ages. That is why wind power will be integrated in courses as early as upper secondary school. Wind power courses are also needed in higher education levels. At Chalmers University of Technology, learning material for new courses is needed in advanced level, with total focus on wind power.

## 1.3 Problems

Wind power technology has been developed during centuries. Lately, the development has increased rapidly. More wind power was installed in EU than any other electrical energy producing source in 2008. During this year, wind energy was 36% of all newly built electricity generating units, which exceeds all other techniques including nuclear power, gas and coal. In average, 20 new wind power plants were installed every working day.

During 2008, a total amount of 160 000 new employees was involved directly or indirectly in the wind power sector in Europe. (EWEA, 2009)

Sweden produces today about 1.4 TWh wind power a year. The goal is to increase the wind power production to 30 TWh until year 2020. To make this possible, there is a need for education of competent personnel. Therefore, new courses with focus on wind power are needed in different education levels.

#### **1.4 Delimitation**

The report will handle only land based horizontal axis wind power plants, as they are the most common used. A basic course material is at disposal and a more specific area handled is the electrical part of wind power plants and how to connect them to the power grid correctly, in order to keep good power quality. The course material for students in upper secondary school is in Swedish and limited to a basic level. The more advanced part is set on a certain level to gain understanding at engineer students, in their master studies. Above all, the course material is concentrated on students with background knowledge in electric power and energy production. Juridical and economical aspects, protection equipments and control systems will not be discussed in this course material.

## 2 Method

Methods used includes searching for literature and information on the Internet and libraries, and to analyze already existing wind power courses at universities in Sweden and Europe to get ideas of appropriate contents of wind power courses. A mind map was created at first, in order to get an overview of the project. Another part of the method was to contact people with important knowledge and make study visits to gather information within the area.

### 2.1 The writing

The writing consists of two different parts, the learning material and the report. The learning material starts with basic information of wind power plants, the development over time, different kinds of constructions and environmental impacts. The basic level is disposed in Swedish to the upper secondary school students and in English to the master students. A more advanced part is presented, only for master students, consisting of a technical advanced description of electrical components and connection of a wind power plant to the grid.

#### 2.1.1 Compendium for upper secondary school

During development of the compendium to upper secondary school “Vindkraft – en förnybar energikälla i tiden”, it was of importance that wind power basics was presented in a clear way, since the students normally do not have any experience of wind power technology. For this reason, it is written in Swedish. The written material can be found in appendix A.

Meetings with Gunnar Orrskog and Susanne Eickhoff, teachers at an upper secondary school in Porthälla, Sweden were arranged. They wanted to teach students about environmental friendly energy sources, focused on wind power and needed help with course material. Discussions about the students’ background knowledge, the teachers’ vision of the course and the competence on Chalmers became the base of the writing of course material adapted to the students. The students also participate at an elaboration at Chalmers, shown in Appendix C.

A meeting with three students from upper secondary school was arranged. The students were participating in a wind energy project and had questions and wanted discuss the subject.

Chosen parts in the compendium are history, construction, environmental impacts, Swedish power grid, power regulation, energy consumption in Sweden and wind energy. Learning material to the students at upper secondary school were made to gain understanding, fascination and a good base before possible more advanced future studies in the subject.

### 2.1.2 Compendium for master students

During development of learning material for master students, some assumptions were made about prerequisites. In this part of the project, basic wind power material is included but the main focus lies on the electrical parts of a wind power plant. The chapters in the master level material are electrical components, generators and connection of wind power plants to the power grid.

In order to find and select appropriate information, literature studies in books and periodicals have been done. Meetings have been arranged with people from different aspects of the wind power industry.

Because of no earlier experience of connection of wind power plants to the grid, assistance was needed to sort out what is of importance to become a part of the compendium and not. A meeting with Åke Larsson in Trollhättan, Sweden, was arranged. He works as a teacher at University West, Trollhättan, and is also employed at Vattenfall. With his background and experiences, Larsson had several ideas and inputs to the work. This meeting made it easier to start writing about connection of wind power plants to the grid.

There have been several meetings with parts of the Power Cluster team from Sweden, discussing education in wind power. In order to find out more about the selection of wind power courses, an investigation was done about wind power courses in Sweden and the other European countries involved in Power Cluster. The information was taken from different universities' webpage. The biggest education unit in wind power in Sweden is located on Gotland.



Figure 2-1: Wind turbines at Näsudden, Sweden.

Visby on Gotland, Sweden, was visited in order to gain insight in the wind power education and what University Gotland has to offer students. University Gotland focuses on wind power courses for students with backgrounds of a wide range. For most of their courses, no demands of earlier studies exist. Chalmers has more advanced level in electric power, which in why during cooperation between University Gotland and Chalmers, may be appropriate that Chalmers focus on the electrical part of the technology of wind power plants.

During the visit at Gotland, Näsudden, an area with many wind turbines and great wind conditions on Gotland, was also visited. A meeting with Göran Olsson at Vattenfall was arranged. Olsson made a presentation about the area, wind turbines and some projects. Visiting Näsudden gave perspective of modern history of wind power plants, as several models with a large variety of rated power and age are operating side by side. Figure 2-1 is taken at Näsudden, Gotland.



**Figure 2-2: Klas Utbult inside the nacelle.**

In order to understand the machinery in a wind power plant, a study visit to Hönö was done. This included a visit inside the nacelle of a 50 m high tower in a 660 kW wind power plant. A photo from the top of it shown in Figure 2-3. Klas Utbult, the service technician guided and explained the different parts of the machinery.



Figure 2-3: On top of the tower of a wind power plant.

## 2.2 Elaboration

Abram Perdana at Department of Electric Power Engineering, Chalmers has developed a dynamical model of a wind power plant in MatLab, which have been studied in order to gain understanding for future work. No new elaborations have been developed, since there already exist two, for this course appropriate elaborations, at Chalmers. They can be studied in appendix C. The elaborations are wind energy exercises, performed in MatLab, divided into two parts; the first one is about wind energy potential and the second one about wind turbine control.



### **3 Discussion**

Wind power was a fairly new subject for us at the beginning of this master thesis. Despite this, there were never any doubts whether it was possible to develop course material or not. In many courses the learning material is unnecessary complicated. Books are often thick and contains more information than required for the course. As students, we have some understanding of what may be experienced difficult in a course. This is to our advantage when producing new course material. The developed material is a compilation of material from many books, in order to gather relevant information in one compendium. It is presented clear and short to get an overview and easy access. During the master thesis, we have gained much understanding of wind power.

University Gotland is a leading university in Sweden with the largest selection of wind power courses. It was a good experience to visit the university and gain insight in their range of wind power courses. The courses have different contents than wind power courses at Chalmers. Planned Chalmers wind power courses focuses on energy production, while at Gotland, the courses focus on project, planning and basic wind power knowledge. For this reason, future wind power courses with focus on technical aspects are needed in general.

Denmark is a leading country in Europe regarding wind power industry as well as education. It is possible to graduate at a master level within wind power in Denmark. At the start of the master thesis, we discussed the possibility of a study visit in Denmark. It would have been interesting to visit universities in Denmark, to take part of course material from a master level, but unfortunately, there was no time left.

Meeting students from upper secondary school had a positive impact on the part of the work intended for that education level. Because of the meeting, it was easier for us to understand what was difficult for them. Writing learning material on a basic level could be difficult, but with input from some students and teachers made it easier to maintain.

Some difficulties were experienced regarding statistical data in the project. Wind power industry is expanding quickly today, and wind power statistics is rapidly outdated. Even if statistical data in this project is relevant for the moment, this report will be old within a few years. Because of this, it is important to update these parts of the project, in order for this material to be used in the future.

The content of the basic education material is chosen to give a basic knowledge of wind power plants. The part intended for secondary upper school have also been developed in collaboration with teachers for this level. Meetings with people in the wind power industry have formulated the content of the part aiming to master students. Our own background as electric power students have naturally also been of importance for this part.

#### **3.1 Conclusion**

The demand of electricity produced by renewable energy is increasing. Especially the wind power industry is rapidly growing and competent personnel are needed. Today, there are

not enough resources on the market. Students need to get interested and involved in wind power technology and more courses have to be developed and available. The already existing wind power courses, especially in Sweden do not cover all areas to get a good base before entering the wind power business.

The material produced in this master thesis is definitely the beginning of new knowledge for students interested in the technology of wind power plants. It is developed to fit master students. In the wind power industry an entirety is needed between different kinds of workers and different countries in Europe. By setting a standard at wind power education in Europe, it is easier for people to work beyond borders. Collaboration is easier when co-workers understand each other and the technology could reach unforeseen levels.

### **3.2 Future work**

The produced material is only a part of the material to a course, which is why there are large possibilities to develop it further. There are many parts excluded from the written learning material, which could be complemented later on. Apart from written material, exercises, projects and elaborations could be added. In order to involve students, get their interest and gain more understanding, study visits to wind farms or single wind power plants may be appropriate. We also find it appropriate to involve companies with the intention of integrating students to labour market.

To get people involved and interested is an important area to work with. It does not matter how well performed the courses are if there are not enough students interested. Of importance is to get students interested in this branch at an early age and get their attention to environmental friendly energy sources, wind power in particular.

There are several things that could be done as future work with this particular project. There are large possibilities for immersion, especially in the chapters regarding electrical system and connection to the power grid.

The focus today lies entirely on wind power in Sweden. Future work of the project could be examination of wind power in the world and studies of similarities and differences between countries.

## Appendix A

### Vindkraft – en förnybar energikälla i tiden

*En övergripande guide om vindkraftverk, dess historia, konstruktion, utbredning och mål inför framtiden*





# Vindkraft – en förnybar energikälla i tiden

*En övergripande guide om vindkraftverk, dess historia, konstruktion, utbredning och mål inför framtiden*

Kristin Bruhn

Sofia Lorensen

Jennie Svensson

2009

---



## INNEHÅLLSFÖRTECKNING

---

<b>Förord</b> .....	<b>1</b>
<b>Vindkraftens historia</b> .....	<b>3</b>
Vindkraftens utveckling genom tiderna .....	3
<i>Viktiga årtal för vindkraftsutvecklingen</i> .....	4
<b>Energianvändning i Sverige</b> .....	<b>9</b>
<b>Konstruktion</b> .....	<b>11</b>
Vindkraftverkets komponenter .....	11
<b>Svenska elnätets uppbyggnad</b> .....	<b>15</b>
Historia .....	15
Överföring av effekt med olika spänningar.....	16
Elnätets uppbyggnad .....	17
<i>Uppdelning av elnätet</i> .....	18
<b>Vinden</b> .....	<b>21</b>
vindenergi.....	21
Vindens kraft .....	21
<i>Betz lag</i> .....	23
Placering av vindkraftverk .....	28
<b>Effektreglering</b> .....	<b>29</b>
Olika typer av effektreglering.....	30
Fast varvtal .....	31
Variabelt varvtal .....	31
<b>Miljöpåverkan</b> .....	<b>33</b>
<b>Litteraturförteckning</b> .....	<b>37</b>





## FÖRORD

---

I dagens samhälle är människan otroligt beroende av elektricitet för att ha en fungerande vardag. El används till allt från datorer och telefoner, till att kunna laga mat och tvätta kläder. Produkter vi använder är tillverkade industriellt, och i dagens konsumtionssamhälle finns många industrier som kräver stora mängder elektrisk energi. Behovet av elektricitet har ökat kraftigt, särskilt under de senaste decennierna. För att tillgodose det växande energibehovet och samtidigt värna om vår miljö, är det viktigt att energin kommer från förnyelsebara energikällor. Med stor sannolikhet kommer behovet av miljövänlig elektrisk energi att öka ännu mer av olika anledningar. Exempelvis pågår omfattande utveckling av fordon vars bränsle inte bidrar till växthuseffekten, bland annat elbilar. Idag är energiproduktionen från vindkraft ca 1,4 TWh i Sverige, vilket är mindre än 1% av den totala energiproduktionen. Den svenska regeringen har ett planeringsmål för vindkraft på 30 TWh till år 2020. Planeringsmålet ger en anvisning om hur stora möjligheter det finns att öka energiproduktionen från vindkraft. Sveriges förutsättningar för en utökad produktion av elektricitet från vindkraft är mycket goda. (GothiaVind - Vindkraft)



## VINDKRAFTENS HISTORIA

---

Människan har tagit tillvara på rörelseenergin som finns i vinden under lång tid på olika sätt. Skepp har seglats över världens hav med hjälp av vind och väderkvarnar har malt spannmål, för att nämna ett par exempel. Metoder för utvinning av elektrisk energi från vinden har utvecklats sedan slutet av 1800-talet och nedan följer en redovisning av viktiga årtal och genombrott för vindkraften. (Sidén, 2009)



FIGUR 1: VÄDERKVARNAR PÅ ÖLAND.

## VINDKRAFTENS UTVECKLING GENOM TIDERNÄ

---

Vindkraftverk har funnits sedan slutet av 1800-talet. Vindkraftverken har varierat i konstruktion och storlek genom tiderna och det är först på senare tid som de fått stor genomslagskraft. Figur 2 ger en överblick av utveckling av vindkraftverk, vilken inleds med väderkvarnar som malar säd och driver maskiner till att avslutas med stora vindfarmer.

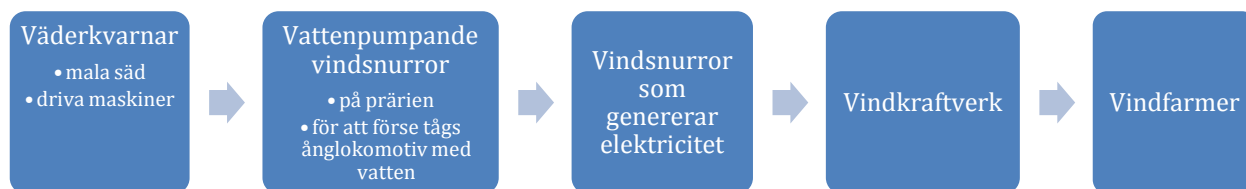

FIGUR 2: ÖVERGRIPANDE UTVECKLING AV VINDKRAFTVERK.

De senaste tio åren har storlek och kapacitet på vindkraftverk ökat. Figur 3 visar storleken på vindkraftverk som producerats åren 1999, 2002, 2003, 2009 och frågetecknet motsvarar vindkraftverk som ligger på ritbordet idag, men som ännu inte finns på marknaden. Höjden beräknas utifrån navhöjden, högst upp på tornet. Exempelvis är 2002 års verk 70 m högt, har en rotordiameter på 70 m och en märkeffekt på 2 MW. Märkeffekt är den maxeffekt vindkraftverket är konstruerat för. Enligt Göran Olsson som arbetar på Vattenfall på Näsudden, Gotland, är det vanligast installerade vindkraftverken, av de stora modellerna, idag kring 2 MW. Det är dock större till höjd och rotordiameter än 2002 års modell. Figuren visar även en jämförelse med kända byggnader som lutande tornet i Pisa, Turning Torso i Malmö och Eiffeltornet i Paris. (Boverket, 2009)

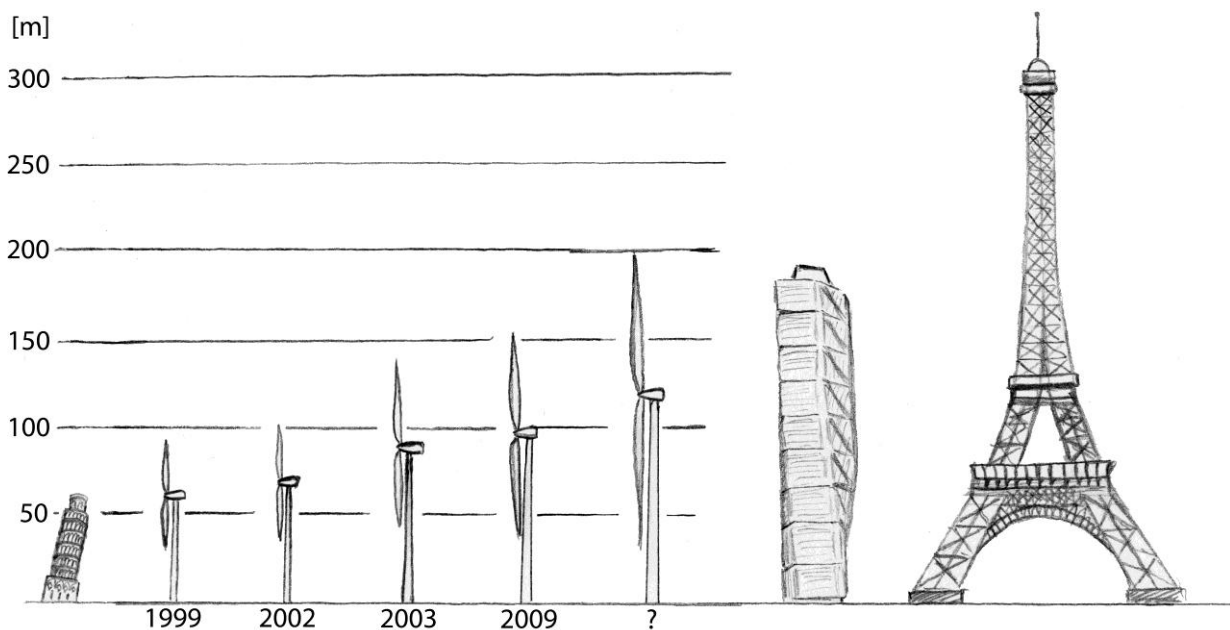

FIGUR 3: STORLEKSJÄMFÖRELSE AV VINDKRAFTVERK PRODUCERADE MELLAN ÅR 1999-2009 OCH KÄNDA BYGGNADER.

---

### VIKTIGA ÅRTAL FÖR VINDKRAFTSUTVECKLINGEN

---

1888 – Brush bygger världens första automatiskt fungerande elektriskt genererande vindkraftverk vintern 1887-1888 i Ohio. Det är vridbart för att ha möjlighet att stå vänt mot vinden för att få ut önskad effekt, har 144 blad och en diameter på 17 m. I tjuugo år är vindkraftverket i drift och laddar på så sätt batterierna i hans herrgård. (20th Century Developments, 2002)

*1891* – Dansken Poul la Cour utvecklar det första vindkraftverket som genererar elektricitet med hänsyn till aerodynamiska designprinciper med fyra rotorblad som får sin form utifrån flygplansvingarnas. (20th Century Developments, 2002)

*1908* – Danmark har 72 vindkraftverk (20th Century Developments, 2002)

*1931* – Ryssland bygger ett stort vindkraftverk som placeras vid kusten av Kaspiska havet. Det producerar 200 MWh elektricitet på två år. (20th Century Developments, 2002)

*1930-1940 i USA* – Energibehovet ökar hos bönder med stora lantbruk. Den stora depressionen i slutet av 1920-talet drabbade många länder hårt, särskilt USA, och regeringen sporras att utöka det elektriska nätet för att tillgodose ökat energibehov och stimulera den deprimerade ekonomin. Detta leder till fortsatt utveckling av vindkraftverk. (20th Century Developments, 2002)

*1935-1970* – Omfattande forskningsarbete pågår angående storskaliga vindkraftverk i flertalet länder, så som Tyskland, Danmark, USA, Frankrike och Storbritannien. De teoretiska resultaten visade att vindkraft i stor skala skulle fungera, men inga praktiska försök lyckas. (20th Century Developments, 2002)

*1941* – Det största vindkraftverket på sin tid, med 53 m i rotordiameter och 1,25 MW märkeffekt, installeras i Vermont 1941. 1945 går ett av rotorbladen av, förmodligen på grund av utmattat material och tung konstruktion. (20th Century Developments, 2002)

*Efter Andra världskriget som är slut 1945* – Den europeiska utvecklingen inom vindkraft sätter fart åter igen, eftersom priset på fossila bränslen går upp. Nu inriktas utvecklingen på att vindkraftverk ska kunna kopplas in på stora elnät. (20th Century Developments, 2002)

*1957* – Danskarna utvecklar ett vindkraftverk i Gedser som är inkopplat på elnätet och är i drift till 1967. Vindkraftverket är mindre än det i Vermont, med 200 kW märkeffekt och en rotordiameter på 24 m. (20th Century Developments, 2002)

*1957-1968* - Ulrich Hutter, en tysk pionjär inom vindkraftstekniken, utvecklar flera avancerade horisontalaxlade vindkraftverk med blad av glasfiber för att få en lätt och hållbar konstruktion. (20th Century Developments, 2002)

*1970-talets slut* – Intresset ökar för vindkraftsteknologi till följd av stigande priser på fossila bränslen. Dessutom har ett antal kärnkraftsolyckor inträffat som satte igång miljödebatter. Nya energikällor undersöks, speciellt de som är förnybara, till exempel vindkraft. (Wizelius, 2002)

*1979-1983, Sverige* – Utveckling och forskning pågår om vindkraft. Näsudden på södra Gotland visar sig ha goda vindförhållanden, och en prototyp till ett vindkraftverk på 2 MW byggs och sätts i bruk. (Vattenfall, 2008)

*1997-2008, Sverige* – Projektet Lillgrund, som är Sveriges första havsbaserade vindkraftspark, genomförs. Det tar många år innan Lillgrund kan börja byggas, eftersom många tillstånd behövs innan byggnadsprocessen kan starta. Mellan mars 2006 och december 2007 byggs vindkraftsparken. I juni 2008

invigs den och är den tredje största vindkraftsparken i världen med 48 verk a 2,3 MW. Lillgrund genererar nu el motsvarande 60 000 hushålls årliga förbrukning. (Vattenfall, 2009)

2002, Sverige – Regeringen föreslår ett mål om att producera 10 TWh förnybar energi år 2010 och 10 TWh vindkraftselektricitet år 2015. (GothiaVind - Vindkraft)

2003, Sverige – Elcertifikatet introduceras för att uppmuntra användning av förnybar energi. Energin kan komma från följande källor för att få elcertifikat: vindkraft, vattenkraft, vågenergi, solenergi, kraftvärmeverk och vissa biobränslen.(Boverket, 2009)

2006 – Mer än 93 000 vindkraftverk är installerade runt om i världen. (Boverket, 2009)

2007, Sverige – Regeringen föreslår ett nytt mål, med 30 TWh vindkraftproducerad energi år 2020. Av dessa ska 10 TWh komma från havsbaserad vindkraft och 20 TWh från landbaserade vindkraftverk. (GothiaVind - Vindkraft)



FIGUR 4: VINDKRAFTVERK PÅ NÄSUDDEN, GOTLAND, 2009.

Figur 5 ger en grafisk förståelse över hur vindkraft har expanderat i Sverige. Den visar totalt antal vindkraftverk i drift, total installerad kapacitet och total energiproduktion baserad på vindkraft. Installerad kapacitet visar inte nyinstallerad kapacitet varje år, utan den totala kapaciteten. Eftersom det inte blåser märkvind hela tiden kommer den totala kapaciteten inte kunna utvinnas, därför visas energiproduktion med en egen kurva. Y-axeln har olika betydelser beroende på vilken kurva som studeras. För antal vindkraftverk betyder y-axeln antal [st], för installerad kapacitet är det effekt [MW] som visas och när energiproduktion studeras är det energi [GWh] som visas på y-axeln. (Energimyndigheten, 2008)

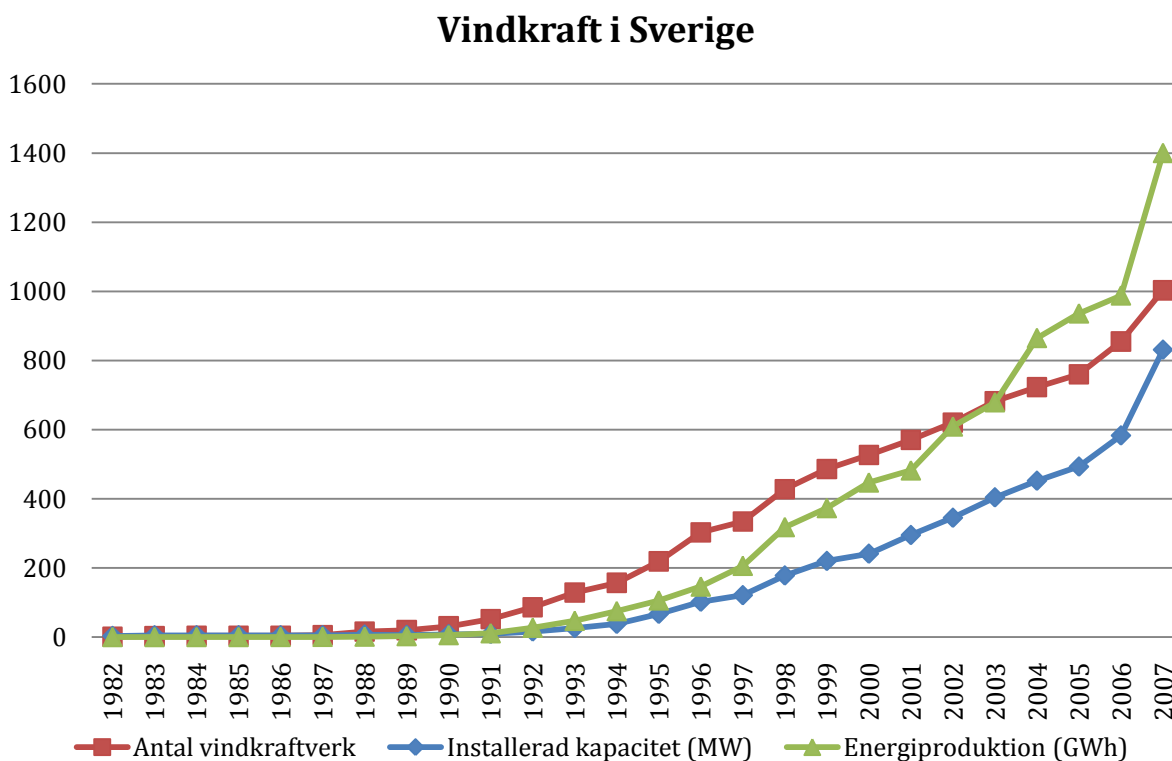

FIGUR 5: ANTAL VINDKRAFTVERK, INSTALLERAD EFFEKT OCH ENERGIPRODUKTION I SVERIGE 1982-2007.

Från 1993 och framåt har det hänt mycket inom vindkraftsbranschen. Den största ökningen av utbyggnad och produktion skedde mellan åren 2006-2007. För att Sverige ska nå regeringsmålet på 30 TWh till år 2020 måste expansionen av vindkraft öka ännu mer. (Energimyndigheten, 2008)

## Total installerad vindkraftskapacitet i världen

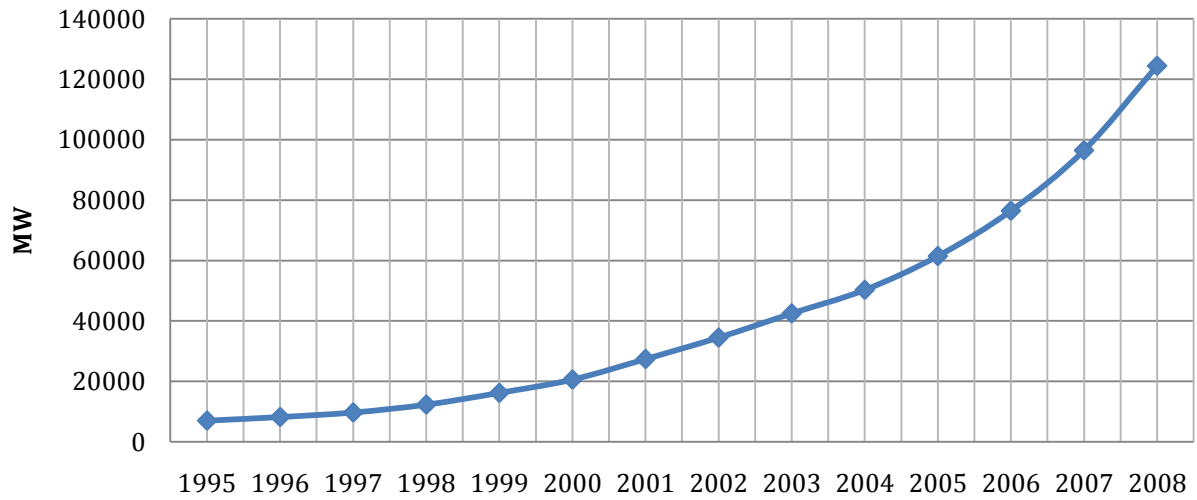

FIGUR 6: INSTALLERAD VINDKRAFTSKAPACITET I VÄRLDEN.

I världen har vindkraftkapaciteten expanderat mest efter 2004, vilket visas i Figur 6. År 2008 fanns det knappt 125 000 MW installerad vindkraft i världen.



## ENERGIANVÄNDNING I SVERIGE

Energi är nödvändigt för att det moderna samhället ska fungera. Värme, bränsle och elektricitet är energiformer som används dagligen. I Sverige är det framför allt inom tre områden som energi förbrukas; industri, hushåll och service där mycket energi går åt till uppvärmning av byggnader och transporter

- *Industrin* kräver energi för att kunna tillverka olika produkter och material. Trots att den industriella produktionen har ökat de senare decennierna, använder svensk industri idag i stort sett lika mycket energi som år 1970. (Energimyndigheten, 2008)
- Energi behövs till hushåll och service för att värma upp *byggnader*, som kontor och bostäder. De flesta byggnader försörjs även med elektricitet för spisar, datorer, kylskåp etc. (Energimyndigheten, 2008)
- För att människor och gods ska kunna *transporteras* med bil, flygplan eller järnväg krävs energi. Den totala energianvändningen för transportsektorn, borträknat utrikes sjöfart, har sedan år 1970 ökat med ungefär 87%. (Energimyndigheten, 2008)

### Elproduktion i Sverige 2007

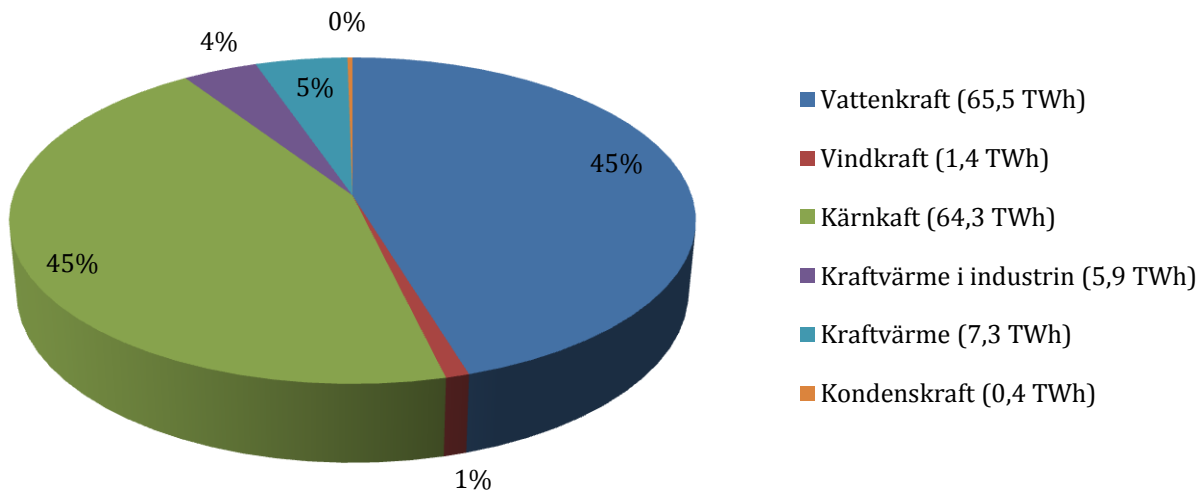

FIGUR 7: SVERIGES ELPRODUKTION 2007, UPPDELAT I PRODUKTIONSFORM.

Figur 7 visar elproduktion i Sverige år 2007. Den visar att vattenkraft och kärnkraft står för 45% vardera av elproduktionen i Sverige. Vindkraftproducerad elektricitet har med sina 1,4 TWh per år ca 1% av marknaden. De andra produktionsformerna är kraftvärme, kraftvärme i industrin och kondenskraft. Figur 8 visar elproduktion i Sverige mellan åren 1970 och 2007. Den visar att elproduktionen mer än fördubblades mellan 1970-1985 och att den var som högst 2001. (Energimyndigheten, 2008)

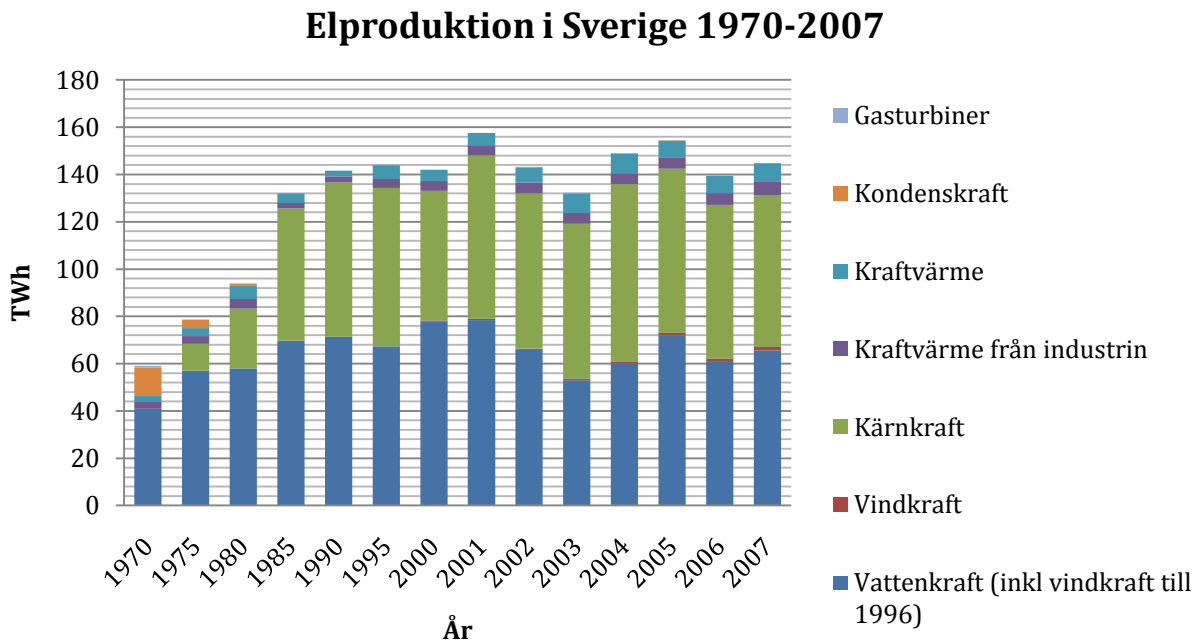

FIGUR 8: SVERIGES ELPRODUKTION, 1970-2007.

## KONSTRUKTION

---

Ett vindkraftverk omvandlar vindens rörelseenergi till elektrisk energi. I princip fungerar vindkraftverket enligt följande:

1. Vinden får rotorn på vindkraftverket att rotera.
2. Ett vridmoment skapas på axeln som driver generatoren.
3. Generatoren omvandlar den mekaniska energin till elektrisk energi.

### VINDKRAFTVERKETS KOMPONENTER

---

Ett vindkraftverk består av ett antal huvudkomponenter, som visas i Figur 9. Fundamentet är underbyggnaden som ger vindkraftverket stadga. Tornet är oftast tillverkat av stål och har formen av en kon. Maskinhuset innehåller växellåda, elektriska komponenter och generator. Rotorn består av rotorblad som sitter fast i ett nav som till slut är sammanlänkat med generatoren genom en axel. Rotorn kallas även vindturbin, eller enbart turbin. Girmotorn roterar maskinhuset så att det står mot vindriktningen. Växellådan ser till att förhållandet mellan rotorns hastighet och generatorns överensstämmer. Styrsystemet har flera funktioner, exempelvis att hantera information så att effektereglering sker och att vindkraftverket vrids i rätt vindriktning när det behövs. Transformatorn ser till att spänningsnivån motsvarar den på elnätet, där vindkraftverket kopplas in. Det finns en rad olika sätt att konstruera ett vindkraftverk. Storlek på torn och rotorblad varierar mellan olika modeller och det elektriska systemet kan ha olika utseenden. (Wizelius, 2002)

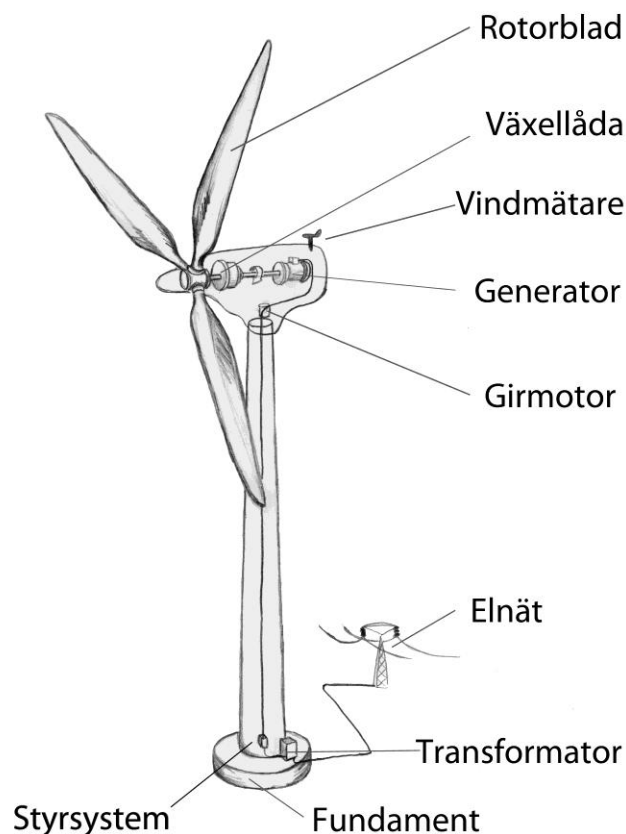

FIGUR 9: ETT VINDKRAFTVERKS HUVUDKOMPONENTER.

Huvudsakligen finns det två typer av vindkraftverk, vertikalaxlade och horisontalaxlade. Den vanligaste sorten, som ofta syns i svenska landskap, är en turbin på ett högt torn, som visas i Figur 10. Det kallas horisontalaxlat vindkraftverk, eftersom axeln mellan rotor och generator, inuti maskinhuset högst upp i tornet, ligger horisontellt. Dessa verk är dominerande på marknaden idag. (Wizelius, 2002)

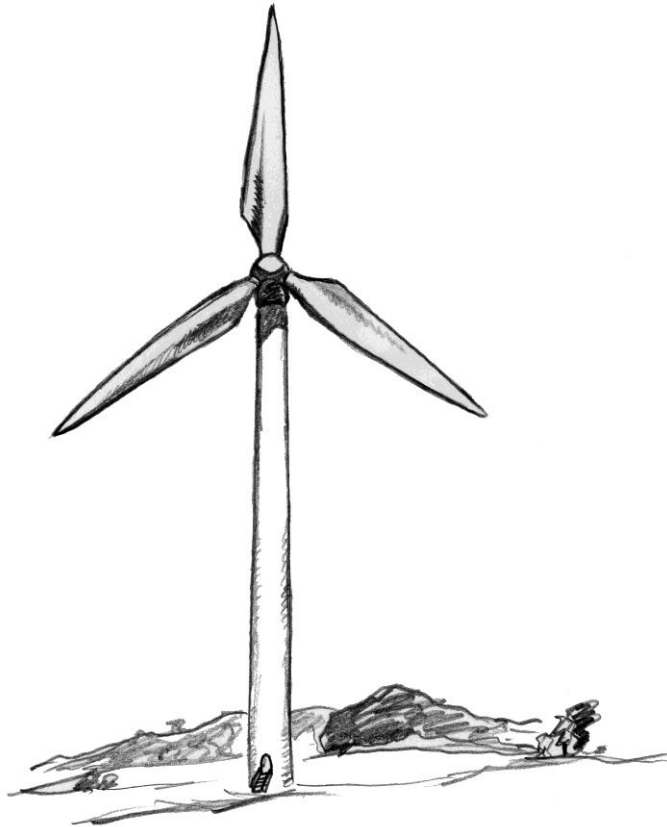

FIGUR 10: HORIZONTALAXLAT VINDKRAFTVERK.

En fördel med vertikalaxlade turbiner, som visas i Figur 11, är att maskinhuset innehållande generator och växellåda, kan placeras på marken, vilket gör det enklare att underhålla än när maskinhuset är högt över marken som hos horisontalaxlade vindkraftverk. Trots det är vertikalaxlade verk ovanliga, eftersom de ännu inte är tillräckligt utvecklade för den kommersiella marknaden, då konstruktionen inte uppnått samma hållbarhet och prestanda som horisontalaxlade vindkraftverk. Därför kommer enbart horisontalaxlade vindkraftverk att diskuteras i fortsättningen. (Wizelius, 2002)



FIGUR 11: VERTIKALAXLAT VINDKRAFTVERK.

Danmark är ledande inom vindkraft och det flesta vindkraftsverk i Sverige är uppbyggda enligt dansk design, med tre blad. Även om denna konstruktion är vanligast så existerar det vindkraftverk med annat antal rotorblad. Fördelar med att ha färre blad, ett eller två, är minskade materialkostnader, samt att de väger mindre. Turbiner med två eller tre blad är ungefär lika effektiva. Fler eller färre antal blad innebär en minskad effektivitet. Anledningen till att det är vanligast med tre rotorblad är att dessa verk är tystare och mer estetiskt tilltalande och uppfattas snurra mer harmoniskt än tvåbladiga vindkraftverk. (Sidén, 2009)



## SVENSKA ELNÄTETS UPPBYGGNAD

---

Det svenska elnätet är uppdelat i olika nivåer. Myndigheten Svenska Kraftnät äger stamnätet som stäcker sig från norra till södra Sverige. Stamnätet, som även kallas för transmissionsnätet förgrenar sig till mindre nät som regionnät, distributionsnät och sedan till konsumenter. De olika näten har olika spänningsnivåer. Stamnätet har högst spänning och konsumtionsnätet har lägst spänning. (Elteknik) (EMC, elkvalitet och elmiljö, 2007)



FIGUR 12: HÖGSPÄNNINGSLEDNINGAR I NORRA NORGE

## HISTORIA

---

I slutet av 1800-talet påbörjades utbyggnad av nätet i städerna och senare även på landsbygden. Till en början producerades det endast el till industrierna, men i vissa fall räckte det även till hushåll i närheten. Elen i hushållen användes främst till lampor. Näten som byggdes var små och försörjdes av elektricitet från enbart ett kraftverk. De olika nät som byggdes hade dessutom olika frekvenser eftersom det inte fanns någon standard för hur el skulle generas. Idag har hela vårt elnät frekvensen 50 Hz. Först på 1930-talet uppkom ett sammankopplat nät på 130 kV i söder och ett annat nät på samma spänningsnivå i norr. (Elteknik) (EMC, elkvalitet och elmiljö, 2007)

Vattenkraften byggdes ut i norra Sverige medan huvudkonsumtionen fanns i södra Sverige. Det insågs snabbt att 130 kV inte skulle vara en tillräckligt hög spänningsnivå för att överföra stora effekter utan att

även medföra stora förluster. Därför byggdes elnätet ut till 220 kV år 1936. Vattenkraften växte ytterligare under 50-talet och då behövde spänningsnivån höjas ytterligare. 1952 använde Sverige, som första land i världen, en 400kV ledning som gick från Harsprånget till Hallsberg. Idag används huvudsakligen en spänningsnivå på 400 kV i stamnätet, men i vissa delar av Sverige används även 220kV. (Elteknik) (EMC, elkvalitet och elmiljö, 2007)

## ÖVERFÖRNING AV EFFEKT MED OLIKA SPÄNNINGAR

---

Anledning till att elnätet är uppdelat i olika nivåer är att man vill ha optimal överföring av effekten. Antingen överförs el vid hög spänning och låg ström eller vid låg spänning och hög ström. Avvägningen bestäms beroende på kostnad och förluster i ledningarna. Faktarutan nedan förklarar huvudkomponenter i ett elnät. (Elteknik)

Ledningens uppgift är att överföra effekt från en punkt till en annan. Effekt ska överföras från kraftverk till konsument. I en ideal ledning är det exakt samma effekt som når kund, som vindkraftverket producerar, men i verkligheten finns inga ideala ledningar, utan det kommer att bli förluster av effekt på vägen. Förlusterna beror på faktorer som ledningens längd, samt storlek på spänning och ström. (Elteknik)

**Generator:** Maskin som skapar elektrisk energi. Exempel på generator är en cykeldynamo, som utnyttjar det snurrande hjulet för att få cykellampan att lysa. Generatorer finns i exempelvis vindkraftverk, vattenkraftverk och kärnkraftverk.

**Transformator:** Förvandlar hög spänning till låg, eller tvärtom.

**Ställverk:** Ett elnät består till största delen av ledningar. Ledningarna är kopplade till varandra genom ställverk. Ett ställverk är en anläggning som gör att man kan dirigera elkraft från ingående ledningar till utgående ledningar på ett säkert och bra sätt. Med hjälp av transformatorer på anläggningen kan förändras spänningsnivån mellan olika ledningar.

**Brytare:** Elektrisk komponent som används för att bryta och sluta en elektrisk krets.

*Hög spänning* används vid långa överföringssträckor. Hög spänning innebär att det är låg ström och då kan ledningarna göras tunnare, vilket i sin tur blir billigare. Istället blir komponenterna i nätet dyrare, men effektförlusterna blir mindre vilket man tjänar på. (Elteknik)

Vid *låg spänning*, som används vid kortare avstånd, måste ledningarna göras tjockare för den höga ström som skall överföras. I detta fall kommer ställverken att bli billigare, men förlusterna av effekt lite högre. (Elteknik)



## ELNÄTETS UPPBYGGNAD

---

Sveriges elnät är sammankopplat med de övriga nordiska länderna, med undantag av Island. Detta visas i Figur 13. Elnätet är uppbyggt av olika spänningsnivåer som ändras med hjälp av transformatorer inuti olika ställverk, även kallat stationer. Figur 14 visar olika stationer sorterade efter spänningsnivå, med högst spänning överst. (Elteknik)



FIGUR 13: SAMMANKOPPLAT ELNÄT I NORDEN.

---

## UPPDELNING AV ELNÄTET

---

*Transmissionsnätet* är det nät som knyter samman alla kraftverk med hög effekt och de större regionernas nät. Nätet används för att transportera el långa sträckor. De långa sträckorna kräver att spänningen är hög för att förlusterna skall bli så små som möjligt och spänningen på dessa ledningar är vanligtvis 400 kV. (Elteknik)

*Regionnätet* fördelar elen inom en region. Transportsträckan brukar vara omkring 100 km och kräver då spänning på omkring 130 kV. Det förekommer även 50 kV och 70 kV. Regionnätet är slingformat och har flera inmatningspunkter från transmissionsnätet. Anledningen till att nätet är slingformat är att vid eventuella fel skall en slinga kunna kopplas bort utan att det påverkar elleveransen. Större industrier är direkt inkopplade på detta nät och även mindre kraftverk kopplas in här. (Elteknik)

*Distributionsnätet* fördelar el inom ett mindre område. Elen transporteras sträckor som vanligtvis inte är längre än 10 km. Lämplig spänning för sådan eltransport är 10 kV - 20 kV. Distributionsnätet är slutna slingor som matas från två håll. De flesta mindre företag tar sin el direkt från distributionsnätet. I tätorter är ledningarna nergrävda i marken, så kallade jordkablar. De har inte flera inmatningspunkter eftersom det sällan uppstår fel i dessa. De fel som kan uppstå i privatpersoners elförbrukning kommer nästan uteslutande från fel i distributionsnätet. Kravet på tillförlitlighet är mindre i distributionsnätet, då det är färre antal konsumenter som påverkas vid fel, jämfört med fel i stamnätet exempelvis. (Elteknik)

Efter distributionsnätet ska elen fördelas ut till *konsumenterna* som består av alla hushåll. Spänningen i vanliga vägguttag är 230 V. Apparater i hushållen är anpassade att fungera bäst vid denna spänning. Tabell 1 visar namnen på de olika näten, deras spänningsnivå och möjlig effektöverföring i en ledning. Då större effekter ska överföras används flera parallella ledningar. En övergripande beskrivning hur de hänger samman visas i Figur 14. Stora vindkraftsfarmer kopplas in på transmissionsnätet. Vindkraftsfarmer mindre än 600 MW och enstaka vindkraftverk som generar mellan 500 kW och 5000 kW kopplas in på regionnätet. Enstaka verk som generar upp till 500 kW kopplas in på distributionsnätet. (Elteknik)(Boverket, 2009)

<i>Elnätsnamn</i>	<i>Spänningsnivå</i>	<i>Effekt [MW]</i>
Transmissionsnät	400 kV	1000
Regionnät	130 kV	100
Distributionsnät	10 kV	10
Konsumtion	230 V	0-1

TABELL 1: SAMMANFATTNING ÖVER OLIKA NÄT I SVERIGE.

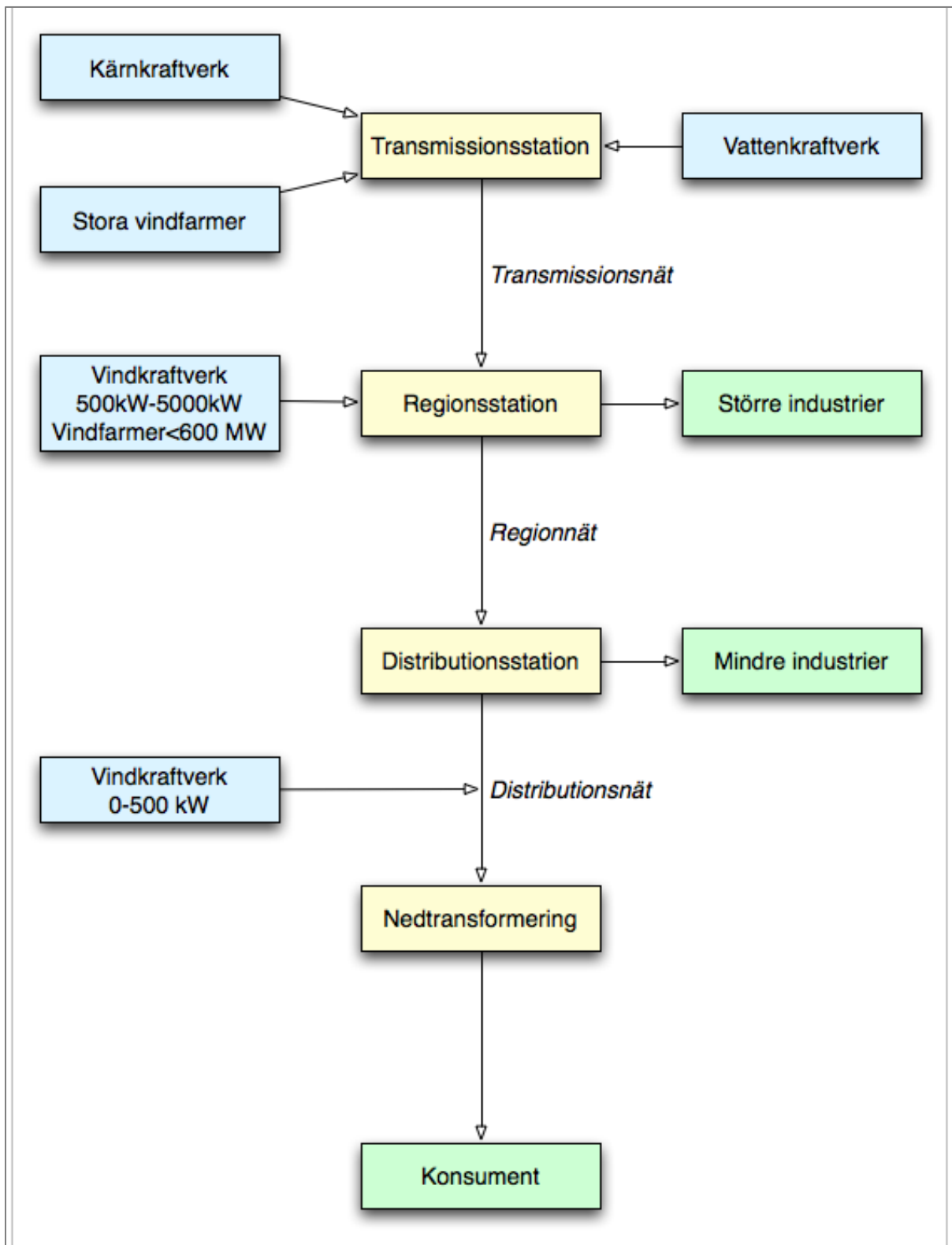

FIGUR 14: DET SVENSKA KRAFTNÄTETS UPPBYGGNAD.



## VINDEN

---

Vinden är en förnybar energikälla som aldrig tar slut, vilket gör den önskvärd att använda inom energiproduktion. Vindenergi kan användas med hjälp av vindkraftverk för att förvandla rörelseenergi till elektrisk energi. Placering av vindkraftverk är viktigt eftersom det påverkar effektiviteten då det blåser olika mycket på olika platser.



## VINDENERGI

---

Solen är ursprungligskällan till vind. Jorden och luften värms upp olika mycket på olika platser. Mer värme överförs från solen exempelvis i områden vid ekvatorn, än vad det gör hos oss i Sverige. Naturen eftersträvar alltid jämvikt, vilket gör att luftmassor med olika tryck och temperaturer rör sig relativt varandra. När solen värmer luftmassorna försöker de fördela sig så att jämvikt uppstår, och det är detta som sker när det blåser. Denna kinetiska energi (rörelseenergi) är en förnybar källa som aldrig kommer att ta slut. Energin kan fångas upp av ett vindkraftverk och omvandlas till elektrisk energi. (Sidén, 2009)

## VINDENS KRAFT

---

Den maximala teoretiska effekt som kan utvinnas ur vind kan beräknas med Betz lag. Betz lag ger den mekaniska effekten från bladen på vindkraftverket. Det går inte att omvandla exakt all mekanisk effekt till elektrisk effekt. Den elektriska effekten kommer att vara något lägre och anledningen till det är att det kommer att försvinna en del effekt på vägen från vindturbin till elnätet. Det uppstår förluster i växellåda och generator. De vindkraftverk, i dagsläget, som är mest effektiva har en verkningsgrad på nära 50%. Då vindkraftsteknik utvecklas i dagsläget är det andra saker förutom effektivitet som det fokuseras på. Fokuseringen ligger på att göra vindkraftverk billigare att tillverka, minskad åtgång av

material vid tillverkning, att vindkraftverken blir tystare, mer pålitliga samt enklare att transportera och montera. (Sidén, 2009)

Vindkraftverkens märkeffekt  $P_n$  uppnås då det blåser med märkvindhastighet  $v_n$ . Vid denna hastighet producerar vindkraftverket den maximala elektriska effekt som det är dimensionerat för. Vanligast är att märkvindhastigheten ligger i intervallet 12-15 m/s. Tillverkarna av vindkraftverket bestämmer detta och anledningen till att det brukar ligga omkring 12-15 m/s är att det är mest ekonomiskt gynnsamt med tanke på materialkostnader och produktionsmöjligheter. Då det blåser kraftigare än märkvind måste effekten som ska tas upp av vindkraftverket regleras ned, eftersom det inte kan producera mer effekt än sin märkeffekt. Anledningen är att det sällan blåser kraftigare vindar än märkvindhastigheten, och därför onödigt att dimensionera vindkraftverkets elektriska system för högre vindar. Då det blåser alltför kraftig vind måste vindkraftverket stängas av för att inte gå sönder. Stoppshastigheten ligger vanligtvis på 25 m/s. Krafterna på vindkraftverket är mindre när verket har stannat, även om det fortfarande blåser hårt. Själva verket är konstruerat för att stå emot vindar upp mot 70 m/s. (Wizelius, 2002)

---

## BETZ LAG

---

När vinden passerar vindturbinen kommer den att bromsas upp till viss del. Därför har vinden både mindre energi och lägre hastighet när den passerat turbinen än den hade innan, som visas i Figur 15. Turbinens rotorarea  $A$  motsvarar den streckade ytan i figuren. Det är omöjligt för ett vindkraftverk att omvandla 100% av vindens rörelseenergi till elektrisk energi.



FIGUR 15: LUFTFLÖDET GENOM TURBINEN.

Då en luftmassa flödar med en hastighet  $v$  genom en area  $A$  representerar den ett massflöde av:

$$\dot{m} = \rho Av \text{ [kg/s]} \quad (\text{ekv.1})$$

Luftens rörelseenergi fås genom:

$$E_{kin} = \frac{mv^2}{2} \text{ [J]} \quad (\text{ekv.2})$$

Används massflöde istället för massa i ekvation 2, erhålls ett uttryck för flöde av rörelseenergi per sekund, alltså en rörelseeffekt  $P_{kin}$ :

$$P_{kin} = \frac{1}{2}(\rho Av)v^2 \text{ [J/s] eller [W]} \quad (\text{ekv.3})$$

En vindturbin kan enbart ta ut effekt från vinden genom att sänka vindens hastighet, alltså vindens hastighet bakom turbinen är lägre än vindens hastighet framför turbinen. För grov bromsning av vindhastigheten innebär att vinden passerar runt omkring rotorn. Albert Betz visade år 1927 att maximalt 16/27 eller 59% av vindens energiinnehåll kan tas tillvara i en vindturbin. Detta ger att den maximala effekten som kan utvinnas ur luften är:

$$P_{max} = \frac{16}{27} \frac{1}{2} \rho A v^3 \text{ [W]} \quad (\text{ekv.4})$$

Detta uttryck visar alltså den *teoretiskt* maximala effekt som vindens flödande energi kan omvandla till turbinens roterande. Det gäller för en ideal vindturbin, alltså här tas inte hänsyn till några förluster, utan turbinens verkningsgrad antas vara 100%. (Carlson, 2002)

Vid analys av  $P$  inses följande tre saker:

1. Vindeffekten är proportionell mot densiteten. Eftersom det är lägre densitet i luft på höga höjder, minskar vindenergin på platser som bergstrakter och likande. Det är även lägre densitet i luft då temperaturen är hög. (Carlson, 2002)
2. Vindeffekten är även proportionell mot svept rotor area. Ju större rotorarea, desto mer energi kan utvinnas. (Carlson, 2002)
3. Vindeffekten är proportionell mot kubiken av vindhastigheten. Det är därför viktigt att välja en lämplig plats för vindkraftverken. Ökar luftens hastighet kommer vindenergin att öka i kubik. (Carlson, 2002)



Figur 16 visar en vindeffektkurva med mätningar från Chalmers provstation på Hönö. Data för vindkraftverket visas i Tabell 2.

<i>Data för vindkraftverket på Chalmers provstation på Hönö</i>	
Turbindiameter	13,5 m
Navhöjd	18 m

TABELL 2: DATA FÖR CHALMERS VINDKRAFTVERK PÅ HÖNÖ.

Figur 16 visar dels en teoretisk effektkurva och dels en verklig, för vindkraftverket på Hönö. Den teoretiska kurvan fortsätter öka med ökad vindhastighet medan den verkliga håller ett konstant värde då vindhastigheten har stigit till märkhastigheten. Då märkhastigheten är uppnådd kommer vindkraftverket att börja reglera effekten.

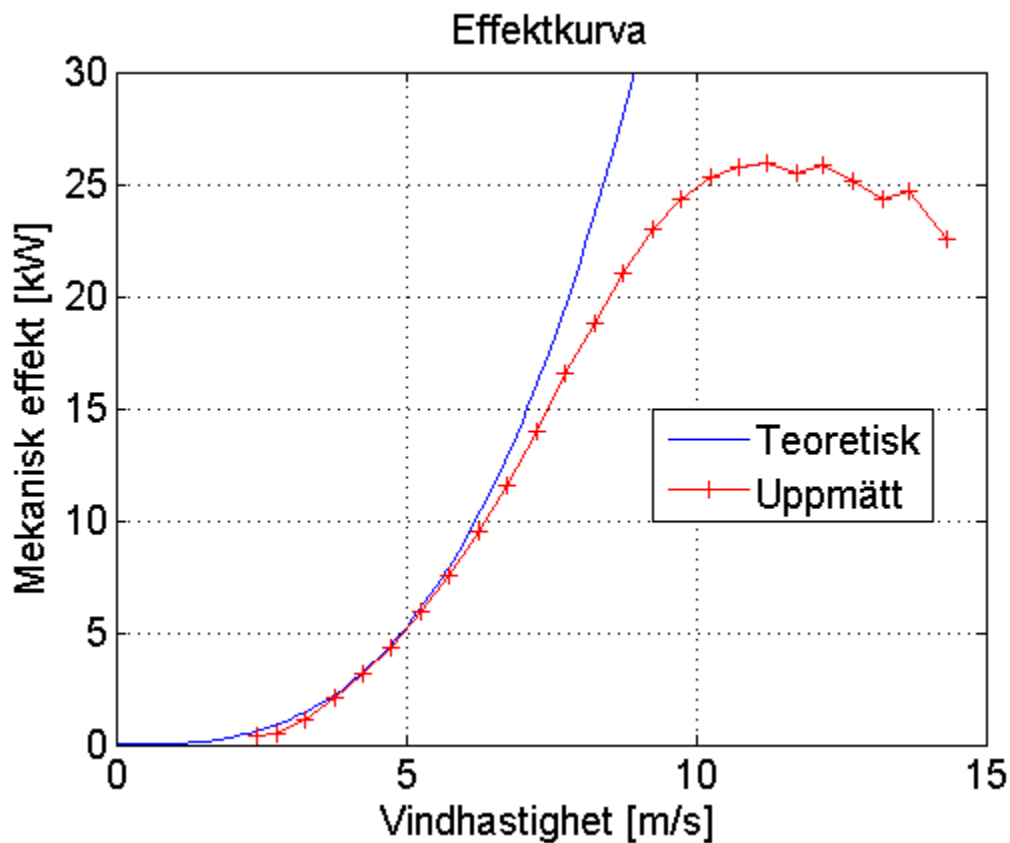

FIGUR 16: TEORETISK- OCH UPPMÄTT EFFEKTKURVA FÖR CHALMERS VINDKRAFTVERK PÅ HÖNÖ.

Löptalet är en viktig parameter när en vindturbin ska designas. Det beskriver hur snabbt bladen roterar i förhållande till vindens hastighet, vilket kan ses i Figur 17.

$$\lambda = \frac{v_{\text{blad}}}{v_{\text{vind}}} = \frac{\omega r}{v_{\text{vind}}}$$

där:

$\lambda$  = löptal

$v_{\text{blad}}$  = bladspetsarnas hastighet [m/s]

$v_{\text{vind}}$  = vindens hastighet [m/s]

$\omega$  = vinkelhastighet [rad/s]

$r$  = rotorns radie [m]

Om vindturbinen roterar för långsamt, kommer den större delen av vinden att passera gapet mellan turbinbladen. Om istället turbinen snurrar för snabbt får luften svårt att passera, och de snurrande bladen kommer att bete sig som en fast vägg mot vinden. Därför designas vindturbiner enligt optimalt löptal, för att utvinna så mycket energi ur vinden som möjligt. Det optimala löptalet beror av antal blad i vindturbinens rotor, samt vilket sorts verk det är, se Figur 17. Där kurvan når sitt maximum inträffar det optimala löptalet. Ju färre blad, desto fortare behöver turbinen rotera för att uppnå maximal energiutvinning. (Tip speed ratio, 2009)

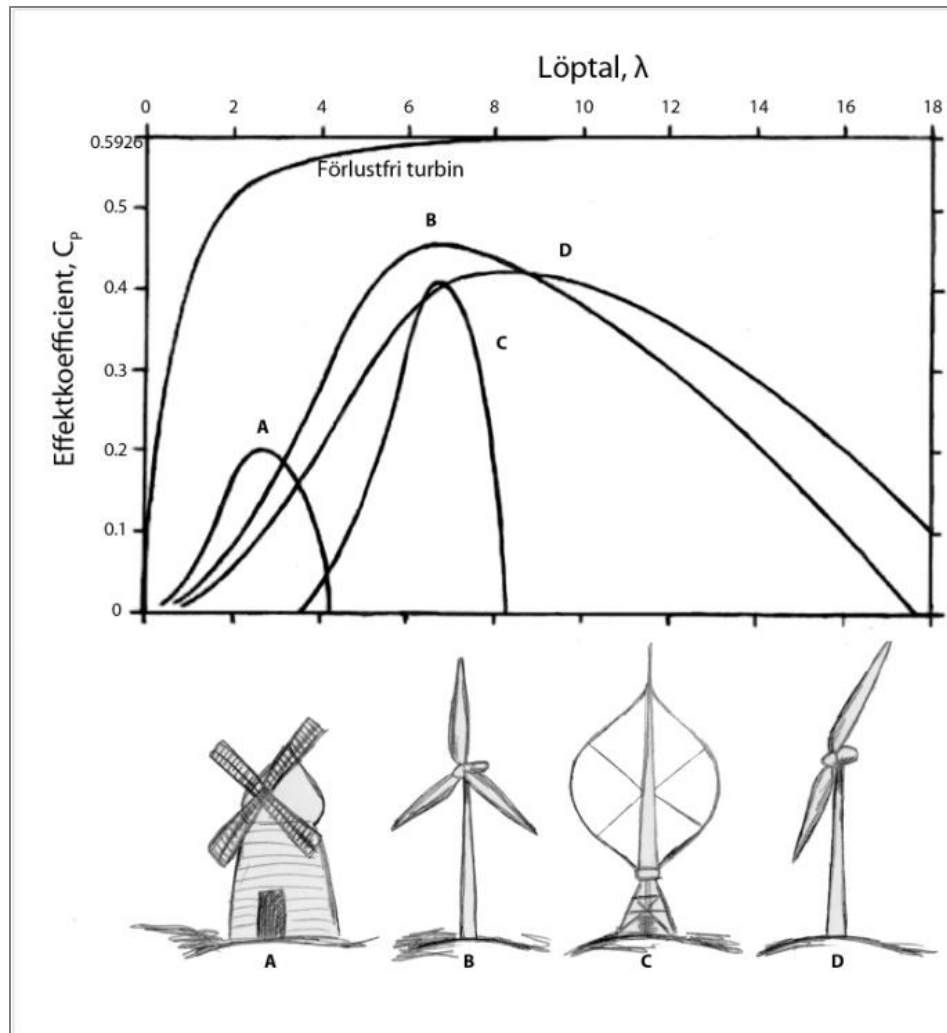

FIGUR 17: ÖVERSIKT AV LÖPTAL FÖR OLIKA TYPER AV VINDTURBINER.

Figur 17 visar en  $C_p$ - $\lambda$  kurva för en väderkvarn, ett horisontalaxlat vindkraftverk med tre rotorblad, ett vertikalaxlat verk och för ett horisontalaxlat tvåbladigt vindkraftverk. I figuren visas att för en vanlig trebladig turbin är effektkoefficienten bäst när löptalet ligger strax över 6. Vingspetsarna på verket ska alltså ha en hastighet som är 6 gånger större än vindhastigheten för maximal produktion. Figuren visar även att mest effekt går att utvinna från horisontalaxlade vindkraftverk med två eller trebladig turbin.

## PLACERING AV VINDKRAFTVERK

---

Vid placering av vindkraftverk finns det att antal faktorer att ta hänsyn till, exempelvis storlek på vindkraftverket med tanke på tornets höjd och rotordiameter. Eftersom det blåser mer på högre höjd, finns det mer energi att utvinna ifall tornet är högt. Det är även möjligt att utvinna mer energi ifall rotordiametern är stor. I dagsläget är generatorerna väl utvecklade och måste förses med en stor mängd vindenergi för att kunna utnyttja sin fulla kapacitet.

När vinden förs in i rotorbladen tas en viss mängd av vindenergin upp medan en del fortsätter rakt igenom och förbi. Efter en viss sträcka har vinden återhämtat sig och innehåller lika mycket energi som innan den träffade rotorbladen. Det innebär att vindkraftverk som står för tätt påverkas av varandra, eftersom det bakomstående inte kommer att kunna utvinna lika mycket energi ur vinden och därmed inte kunna producera lika mycket elektrisk effekt som det främre verket. En tumregel är att det är lämpligt att placera vindkraftverk med ett avstånd av cirka 7-10 rotordiametrar mellan dem. I Figur 18 visas en vindfarm från Falkenberg. (Carlson, 2002)



FIGUR 18: PLACERING AV VINDKRAFTVERK I EN VINDFARM, FALKENBERG.

## EFFEKTREGLERING

Som nämns i föregående kapitel behövs effektregering när det blåser över märkvind, alltså över den optimala vindhastigheten, för att inte slita ut konstruktionen i förtid. Effektregering kan göras på olika sätt, beroende på vad tillverkarna tycker är lämpligt. Det finns tre sorters vanligt förekommande effektregering som sker med hjälp av rotorbladen; bladvinkelregering, överstegsregering och aktiv överstegsregering. Figur 19 visar funktionen hos bladvinkelregering och överstegsregering. I figuren visas turbinbladet i genomskärning, omgivet av vinden. Den rundade sidan är framsidan som möter vinden.

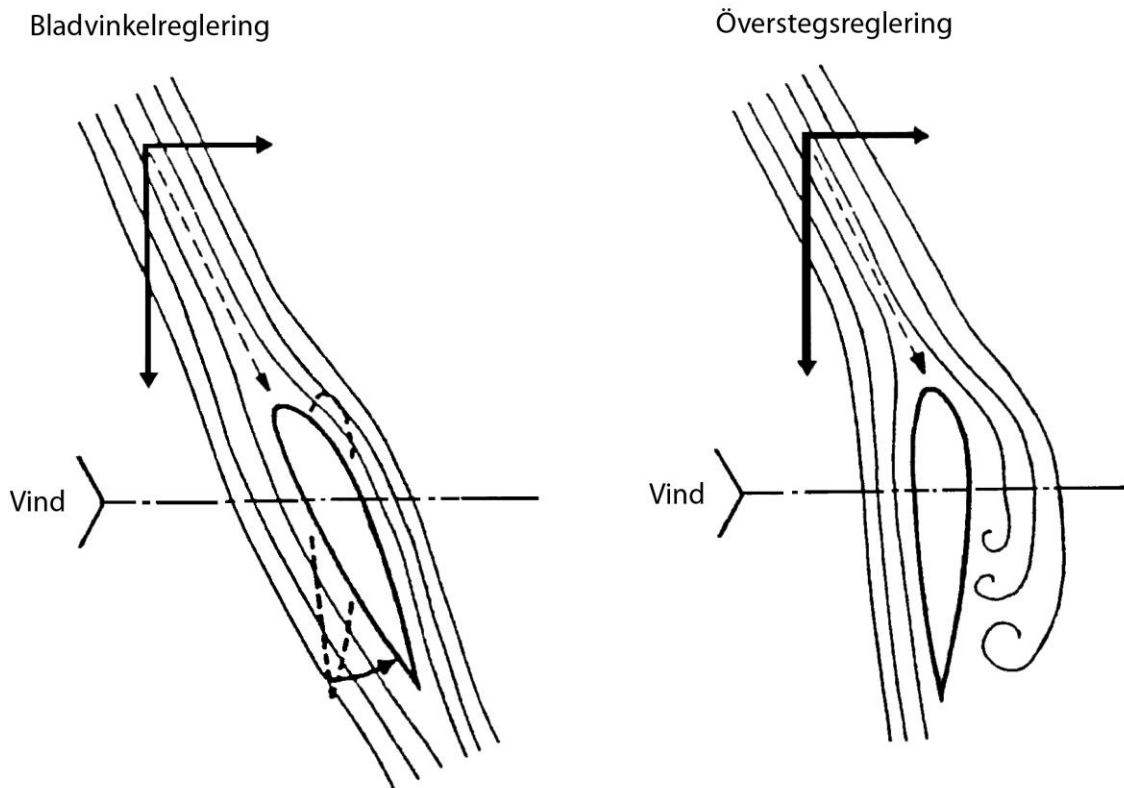

FIGUR 19: BLADVINKELREGLERING OCH ÖVERSTEGSREGLERING.

## OLIKA TYPER AV EFFEKTRGLERING

---

### *Bladvinkelreglering (eng. Pitch control)*

Bladen är justerbara och kan vridas mot eller från vinden, beroende på om vindkraftverket producerar för mycket eller för lite effekt.



FIGUR 20: BROMSSYSTEM PÅ ETT VINDKRAFTVERK MED ÖVERSTEGSREGLERING.

### *Överstegringsreglering (eng. Stall control)*

Detta är den enklaste och mest robusta metoden för att reglera effekten hos ett vindkraftverk. Bladen sitter fast i ett nav och har en fix vinkel. Vindturbinens rotorblad är designade så att när vindens hastighet överstiger ett visst värde kommer skapad turbulens kring bladen få turbinen att regleras så att den hålls på en konstant hastighet. På så sätt kommer aldrig turbinen att snurra fortare än märkhastighet. Om vindkraftverket behöver nödbromsas kan yttre delen av vingen vridas så att det stannar, vilket visas i Figur 20.

### *Aktiv överstegringsreglering (eng. Active stall control)*

Denna regleringsmetod är en blandning av överstegringsreglering och bladvinkelreglering. Vindkraftverkets blad är formade enligt metoden för överstegringsreglering, men de går även att bladvinkelreglera.

## FAST VARVTAL

---

I början av 1990-talet konstruerades standardturbinerna med fast varvtal. Detta innebär att oavsett med vilken hastighet det blåser är turbinens rotorhastighet fixerad och bestäms av frekvensen som finns i elnätet, växellådan och generatorns design. (Ackermann, 2005)

Dessa vindkraftverk är designade för att uppnå maximal effektgenerering vid en viss vindhastighet. Fördelen med vindturbin med fast varvtal är att den är enkel, robust, pålitlig och väl testad. Kostnaden för de elektriska delarna är även låga. Nackdelar är att de har en begränsad kontroll över elkvaliteten. Dålig elkvalitet kan exempelvis visa sig genom att vanliga glödlampor hos elkonsumenter blinkar. Eftersom vindkraftverken har konstant varvtal och rotern går med samma hastighet hela tiden, förs alla variationer i vindens hastighet över till det mekaniska vridmomentet, vilket i sin tur resulterar i variationer i effekten som går ut på elnätet. Om det är ett svagt elnät kan dessa variationer framkalla spänningsfall i punkten där vindkraftverket är sammankopplat med nätet. (Ackermann, 2005)

## VARIABELT VARVTAL

---

Under de senaste åren har vindturbiner med variabelt varvtal blivit dominerande på marknaden. Vindturbiner med variabelt varvtal är designade för att uppnå optimal effekt över ett stort intervall av vindhastigheter. Med variabelt varvtal har det blivit möjligt att kontinuerligt anpassa rotorhastigheten  $\omega$  efter vindhastigheten  $v$ . På detta sätt hålls löpstalet  $\lambda$  konstant vid ett förbestämt värde som motsvarar den maximala effektkoefficienten. Ju högre effektkoefficient vindkraftverket har, desto mer effekt kan det producera. Det elektriska systemet hos en turbin med variabelt varvtal är mer komplicerat än hos en turbin med fast varvtal. Fördelar med att ha variabelt varvtal är att större del av vindens energi kan tas tillvara på, bättre elkvalitet och minskad mekanisk påfrestning på vindturbinen. Nackdelar är förluster som uppstår i elektriska komponenter, att man måste använda större utrustning och ökad kostnad eftersom det blir dyrare med ett ökat antal elektriska komponenter. (Ackermann, 2005)





## MILJÖPÅVERKAN

---

Vindkraft är förnybar och en miljövänlig energikälla eftersom inga CO<sub>2</sub>-utsläpp eller andra växthusgaser förorenar luften vid användande av vindkraftverk. Omgivningen påverkas dock på ett eller annat sätt av vindkraftverk och många studier görs för att begränsa negativa miljöeffekter. Det pratas ofta om tre olika faser där det uppstår en miljöpåverkan, vilka är uppförande, drift och avveckling. (Vindkraft och miljö, 2008)

När vindkraftverk är i drift berörs djur, växtrike och människa på olika sätt. Det har gjorts, och pågår många studier om påverkningar och hur eliminering av dessa påverkningar kan ske. De är uppdelade i utsläpp, landskapsbild, isbildning, fåglar, fladdermöss och fiskar och beskrivs i nedan. (Vindkraft och miljö, 2008)

Det sker inga *utsläpp* av CO<sub>2</sub> eller andra växthusgaser när ett vindkraftverk är i drift. (Vindkraft och miljö, 2008)

Det finns många uppfattningar om hur *landskapsbilden* påverkas i samband med utplacering av vindkraftverk, om den förändras positivt eller negativt. Ett exempel på hur det kan se ut med ett flertal vindkraftverk placerade på Näsudden, Gotland, visas i Figur 21, ett annat är Figur 22, också från Näsudden. För att få en idé om hur vindkraftverk kan förändra landskapsbilden innan de placerats där, kan visualiseras med hjälp av datorprogram. Till havs påverkas landskapsbilden främst då vindkraftverk är placerade nära kustlinjen, annars är problemen mindre än vid landbaserade. (Vindkraft och miljö, 2008)



FIGUR 21: VINDKRAFTVERK PÅ NÄSUDDEN, GOTLAND.

Det är inte vanligt med problem med *isbildning* på vindkraftverk, men om det uppstår är det oftast i kalla fjälltrakter och då på rotorbladen.

Många studier har genomförts för att undersöka vindkraftverks påverkan på *fåglar* och de visar att dem inte påverkas nämnvärt. Fåglar uppmärksammar vindkraftverk tidigt nog för att undvika dem. (Fåglar och vindkraftverk, 2008)

Det har gjorts studier med tanke på hur *fladdermöss* påverkas av vindkraftverk. Kring maskinhuset på vindkraftverk samlas ofta mycket insekter. Eftersom fladdermöss äter insekter kan detta orsaka att de flyger in i vindturbinen när de jagar föda. (Fladdermöss, 2008)

Vid havsbaserade vindkraftverk undersöks exempelvis hur ljud och vibrationer som uppkommer i drift påverkar omgivningen så som *fiskar*. Ljuden är lågfrekventa och sprider sig i vattnet, men påverkar inte djurlivet nämnvärt. Detta visade en undersökning från Bottniska viken, då stresshormonet kortisol samt reaktionen att fly, mättes hos fiskar. En positiv effekt har uppmärksamats vid havsbaserade vindkraftverk; tornet kan komma att fungera som ett artificiellt rev, med alger och musslor som växer på det. Det är bra för djurlivet omkring, då det ofta finns mer fisk vid vindkraftverk. (Fiskar, 2008) (Båmstedt, 2009)



FIGUR 22: VINDKRAFTVERK PÅ NÄSUDDEN, GOTLAND.

*Ljudnivån* från vindkraftverk bör vanligtvis inte överstiga 40 dB hos de som bor i närheten. Ljud från vindkraftverk i drift uppstår från rotorblad och maskinhus. (Vindkraftens miljöpåverkan, 2008)

Vid *avveckling* är det samma typ av miljöpåverkan som vid etablering, alltså transporter och ljud från arbetet vid nedtagande av vindkraftverk. Material som använts kan återvinnas och omgivningen kan återuppbyggas så att det får samma utseende som innan vindkraftverket placerats där. (Vindkraft och miljö, 2008)



## LITTERATURFÖRTECKNING

---

*20th Century Developments*. (2002). (T. W. Development, Producer) Hämtat 2009-06-29 från Illustrated History of Wind Power Development: <http://www.telosnet.com/wind/20th.html>

Ackermann, T. (2005). *Wind power in power systems*.

Båmstedt, L. S. (2009-05-05). *Effekter av undervattensljud från havsbaserade vindkraftverk på fisk i Bottniska viken*. Hämtat 2009-07-27 från Naturvårdsverket: <http://www.naturvardsverket.se/sv/Verksamheter-med-miljopaverkan/Energi/Vindkraft/Vindval/Projekt-och-resultat/Ljud-i-marina-miljon---projekt-inom-Vindval/Effekter-av-undervattensljud-fran-havsbaserade-vindkraftverk-pa-fisk-i-Bottniska-viken/>

Carlson, O. (2002). *Vind- Sol och Vågkraftverk*. Göteborg, Chalmers Tekniska Högskola.

*Elteknik*. Institutionen för Elteknik, Chalmers Tekniska Högskola, Göteborg

*EMC, elkvalitet och elmiljö*. (2007). Hämtat 2009-09-21 från Elforsk: [http://www.elforsk.se/distribut/elkvaldok/nummer%208/bilaga\\_%205b.pdf](http://www.elforsk.se/distribut/elkvaldok/nummer%208/bilaga_%205b.pdf)

Energimyndigheten. (2008). *Energiläget 2008*. Energimyndigheten.

*Fiskar*. (2008-01-15). Hämtat 2009-07-28 från Energimyndigheten: <http://www.energimyndigheten.se/sv/om-oss/var-verksamhet/framjande-av-vindkraft1/Forskning/Djurlivet--/Fiskar>

*Fladdermöss*. (2008-01-15). Hämtat 2009-07-28 från Energimyndigheten: <http://www.energimyndigheten.se/sv/om-oss/var-verksamhet/framjande-av-vindkraft1/Forskning/Djurlivet--/Fladdermoss/>

*Fåglar och vindkraftverk*. (2008-01-15). Hämtat 2009-07-28 från Energimyndigheten: <http://www.energimyndigheten.se/sv/om-oss/var-verksamhet/Framjande-av-vindkraft1/Vindkraftens-effekt-pa-omgivningen/Djurlivet--/Faglar-och-vindkraftverk>

*GothiaVind - Vindkraft*. Hämtat 2009-06-16 från Gothia Vind: <http://www.gothiavind.se/vindkraft.html>

Sidén, G. (2009). *Förnybar energi*. Studentlitteratur.

*Tip speed ratio*. (2009). Hämtat 2009-09-14 från REUK: <http://www.reuk.co.uk/Wind-Turbine-Tip-Speed-Ratio.htm>

Vattenfall. (2009). *Lillgrund vindkraftpark - Ett svenskt pilotprojekt inom havsbaserad vindkraft*. Värnamo, Sweden: Vattenfall Vindkraft.

Vattenfall. (2008-07-10). *Näsudden - centrum för Vattenfalls vindkraftsutveckling*. Hämtat 2009-10-05 från Näsudden - centrum för Vattenfalls vindkraftsutveckling:

[http://www.vattenfall.se/www/vf\\_se/vf\\_se/518304omxva/518334vxrxv/518814vxrxv/521124omxvi/631162karta/565286olida95265/index.jsp](http://www.vattenfall.se/www/vf_se/vf_se/518304omxva/518334vxrxv/518814vxrxv/521124omxvi/631162karta/565286olida95265/index.jsp)

*Vindkraft och miljö*. (2008-09-26). Hämtat 2009-07-28 från Vattenfall:

[http://www.vattenfall.se/www/vf\\_se/vf\\_se/518304omxva/518334vxrxv/518814vxrxv/521124omxvi/567159vindk/index.jsp](http://www.vattenfall.se/www/vf_se/vf_se/518304omxva/518334vxrxv/518814vxrxv/521124omxvi/567159vindk/index.jsp)

*Vindkraft stör näten*. (2009-03-18). Hämtat 2009-07-27 från Ny Teknik:

[http://www.nyteknik.se/nyheter/energi\\_miljo/vindkraft/article538889.ece](http://www.nyteknik.se/nyheter/energi_miljo/vindkraft/article538889.ece)

*Vindkraftens miljöpåverkan*. (2008). Hämtat 2009-07-28 från Naturvårdsverket:

<http://www.naturvardsverket.se/Documents/publikationer/620-8310-6.pdf>

*Vindkraftshandboken - Planering och prövning på land och kustnära vattenområden*. (2009). Boverket.

Wizelius, T. (2002). *Vindkraft i teori och praktik*. Lund, Sweden: Studentlitteratur.

## Appendix B

### Wind Power – A Renewable Energy Source in Time

*A comprehensive guide of wind power plants, its history, construction and impacts on the power grid*







## Wind Power – A Renewable Energy Source in Time

*A comprehensive guide of wind power plants, its history, construction and impacts on the power grid*

Kristin Bruhn

Sofia Lorensen

Jennie Svensson

2009



TABLE OF CONTENTS

---

- Introduction ..... 1**
- Power production and consumption..... 1
  - Electricity business* ..... 4
  - Renewable energy sources*..... 6
- Wind power goals in Sweden and within EU..... 9
- Construction ..... 11
- History ..... 15**
- Energy history with focus on wind power ..... 15
  - Water pumping windmills in the prairie in USA*..... 17
  - Windmills generating electricity* ..... 17
- History of wind power plants ..... 18
- Wind..... 23**
- wind energy..... 23
- Wind power ..... 23
  - Betz law*..... 25
- Placement of wind power plants..... 30
- Construction of the power grid ..... 33**
- The Swedish power grid through time..... 34
- Structure of the power grid..... 35
- Power transmission with different voltage levels ..... 35
- Different grids within the power grid..... 35
  - Transmission grid* ..... 37
  - Region grid* ..... 37
  - Distribution grid* ..... 37
  - Consumption* ..... 38

- Power limitations of wind power plants..... 39**
- Pitch control ..... 40
- Stall control ..... 40
- Active stall control..... 41
- Rotor speed of a wind power plant ..... 43**
- Fixed rotor speed ..... 43
- Variable rotor speed..... 44
- Electrical system..... 45**
- Components ..... 45
  - Soft starter* ..... 46
  - Capacitor bank* ..... 47
  - Frequency converter*..... 47
  - Gearbox*..... 48
  - Rotor brake* ..... 49
- Generators in wind power plants..... 50
  - Induction generator* ..... 51
  - Synchronous generator* ..... 54
- Summary of electric systems..... 56
  - Fixed speed*..... 56
  - Limited variable speed* ..... 57
  - Variable speed with partial scale frequency converter*..... 58
  - Variable speed with full-scale frequency converter* ..... 59
- Connection of a wind power plant to the power grid..... 61**
- Factors affecting frequency and voltage in a power system ..... 61
  - Start up*..... 61
  - During operation* ..... 62
  - Shutting down* ..... 63

Power quality..... 63

**Unbalance in the power system..... 65**

Active power control..... 65

Frequency control ..... 65

Voltage control..... 66

Connection of large production units to the power grid ..... 66

**Environmental impact ..... 69**

Construction..... 69

In operation..... 70

Termination of a wind power plant..... 72

**References ..... 73**



## INTRODUCTION

---

Global warming means that the average temperature of the earth is increasing. The increase that is ongoing at the moment is especially discussed and it is likely that human is the reason for the rapid increase of temperature. Humans have accelerated the process by large emissions, mainly from carbon dioxide, but also from other greenhouse gases that amplifies the natural greenhouse effect. The global average temperature has increased with an average of 0.74 degrees Celsius during the last 100 years. The main part of the warming is likely caused by an increased amount of greenhouse gases in the atmosphere. (Naturvårdsverket, 2007)

The water level in the oceans has risen. This can partly be explained by warming of the existing water in the oceans. Another reason is melting of glaciers, which raises the sea level. Extreme weather events are both rarer and more common. An example of this is a decreased number of cold winter nights and an increased number of hot summer days, which is likely a result of the increased greenhouse effect. Also, the number of tropical cyclones has increased, especially over the Atlantic Ocean. An increased amount of carbon dioxide and other greenhouse gases in the atmosphere will lead to a continued global warming. Continued emission of greenhouse gases will likely lead to a global warming in the 21<sup>st</sup> century that is even faster than the one we have experienced during the 20<sup>th</sup> century. (Naturvårdsverket, 2007)

By exchanging fossil fuels to environmental friendly energy sources, emission of greenhouse gases can be reduced. Environmental friendly sources are solar energy, hydro power, wave energy, bio fuel and wind power.

## POWER PRODUCTION AND CONSUMPTION

---

A durable energy producing system is an important matter today. Politicians all over the world are influencing the energy market to become more environmental friendly, by making decisions that is setting the power production from renewable energy sources in the right direction. In Sweden, the market is mainly affected by decisions made in Sweden and EU, but also by international agreements. (Energimyndigheten, 2008)

The use of different types of energy is important for our modern society to be well functioning. Heat, fuel and electricity are used daily. There are three main areas where energy is consumed, industries, buildings and transportation. This chapter includes facts regarding energy production and consumption, both in Sweden and globally. It also describes environmental friendly energy sources e.g. wind power. (Energimyndigheten, 2008)

Production and consumption of electric power must be kept at the same level. Naturally, the consumed amount of electrical power must be equal to the produced amount in order to achieve balance. Figure 1 shows the use of energy in Sweden 1970-2007. (Energimyndigheten, 2008)

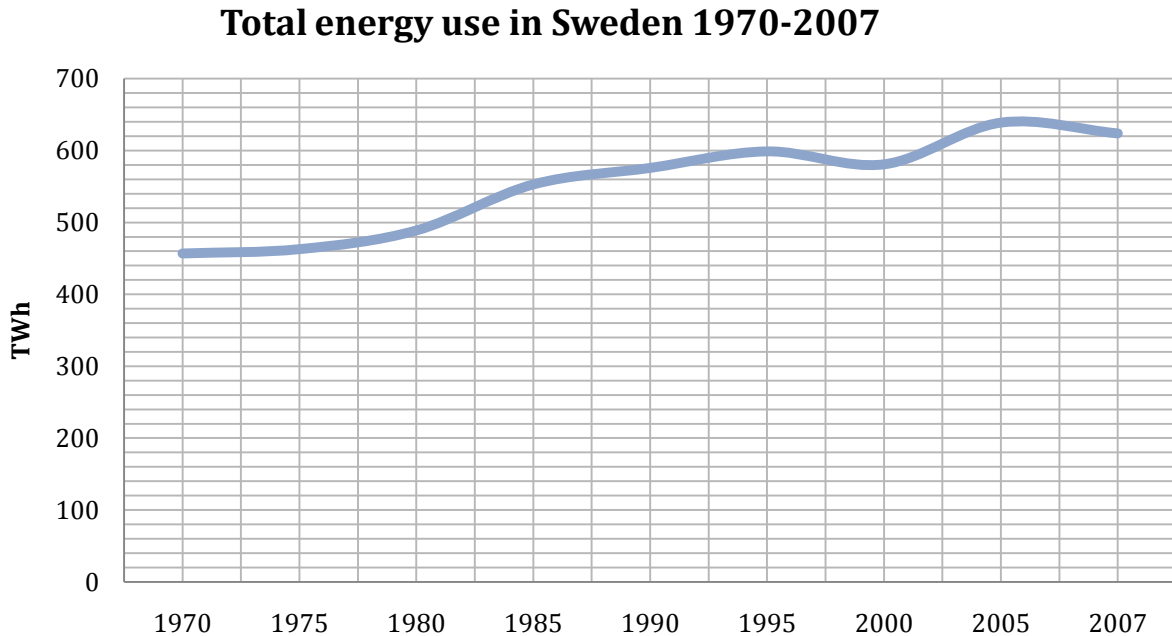

FIGURE 1: ENERGY CONSUMPTION IN SWEDEN 1970-2007. OBSERVE THAT IT IS STEPS OF FIVE YEARS BUT NOT BETWEEN 2005 AND 2007. (ENERGIMYNDIGHETEN, 2008)

The *energy demand* in Sweden increased with 7.7% between 1970 and 2007, but the *energy supply* increased with 36.5% during this period. The reason for this dramatic difference is the changing of energy sources. Private households together with the commercial sector and industries have gone from being large consumers of oil to use electricity and district heating for heating up buildings. The losses are larger when electric energy is used, compared to use of oil, which is the reason why the supply has increased about five times more than the demand between 1970 and 2007. (Energimyndigheten, 2008)



## Total world primary energy supply 1990-2006

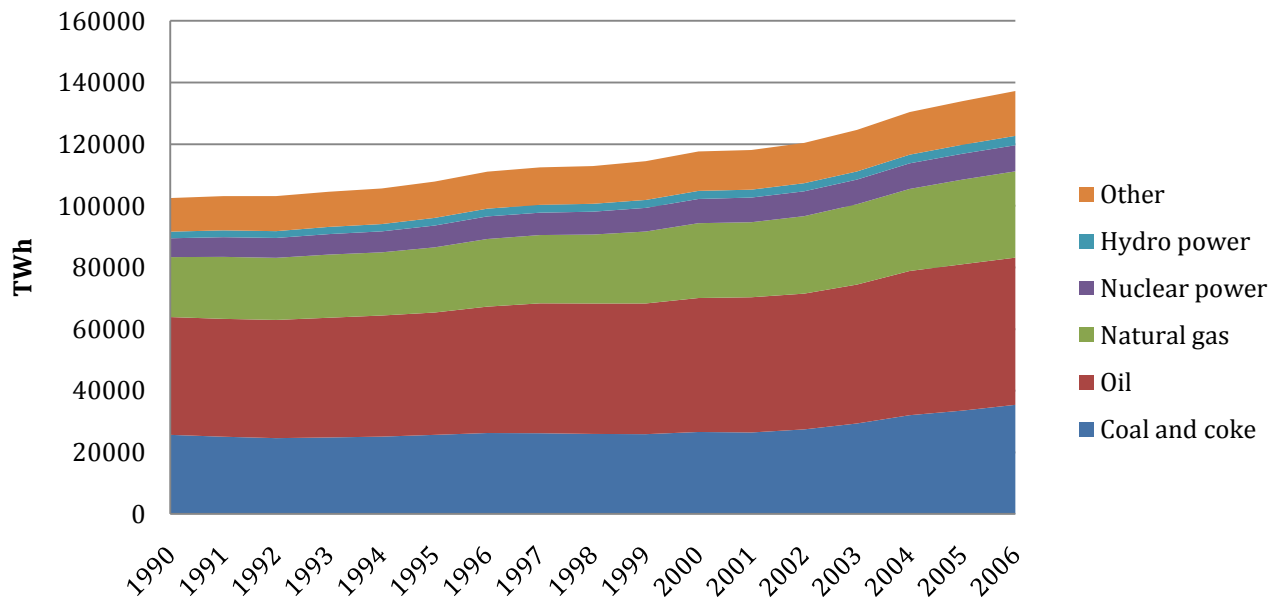

FIGURE 2: TOTAL WORLD PRIMARY ENERGY SUPPLY DIVIDED INTO DIFFERENT SOURCES.  
(ENERGIMYNDIGHETEN, 2008)

The energy supply in the world from different sources 1990-2006 is shown in Figure 2. The total supply increased with almost 34% from 1990 to 2006. The dominating energy source during this period was oil, followed by coal and coke. In 2007, the demand of energy, biomass excluded, increased with 2.4% globally. The growth rate has followed a similar pattern the last ten years. Considering the increased energy demand, China is responsible for more 50% of its total, while the rest of Asia corresponds to 17% of the increase. North America corresponds to 17% of the increased energy demand while EU decreased the total energy use by 2.2%. A high price level of fossil fuel influenced the increased production of bio fuel. Estimation by International Energy Agency, IEA showed that the production of bio fuel in 2007 corresponds to one million oil drums every day. (Energimyndigheten, 2008)

## ELECTRICITY BUSINESS

The production of electricity in Sweden 2007 is shown in Figure 3. The main energy sources are hydropower and nuclear power, both corresponding to 45% each of the total production. Electric energy production from wind power constitutes 1% of the market, which corresponds to 1.4 TWh. Remaining types of production are combined heat and power, industrial backpressure power and cold condensing power. Figure 4 shows the electric energy production in Sweden 1970-2007. It can be seen in the figure that the production has more than doubled between 1970 and 1985 and its highest peak was in 2001. Between 1970 and 1985, the electricity production increased a lot as a result of the increasing demand. Thereafter the level has been more stable. Since 1985, nuclear power has produced about the same amount of electricity as hydropower. (Energimyndigheten, 2008)

### Electricity production in Sweden 2007

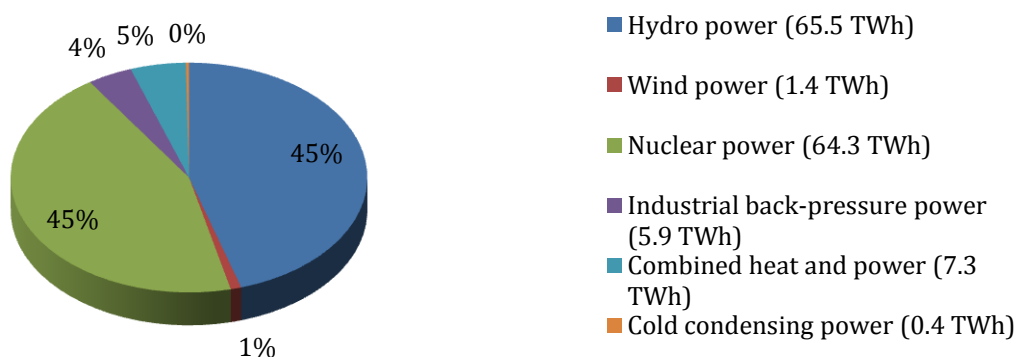

FIGURE 3: ELECTRICITY PRODUCTION IN SWEDEN 2007, DIVIDED INTO DIFFERENT SOURCES. (ENERGIMYNDIGHETEN, 2008)

### Swedish electricity production [TWh]

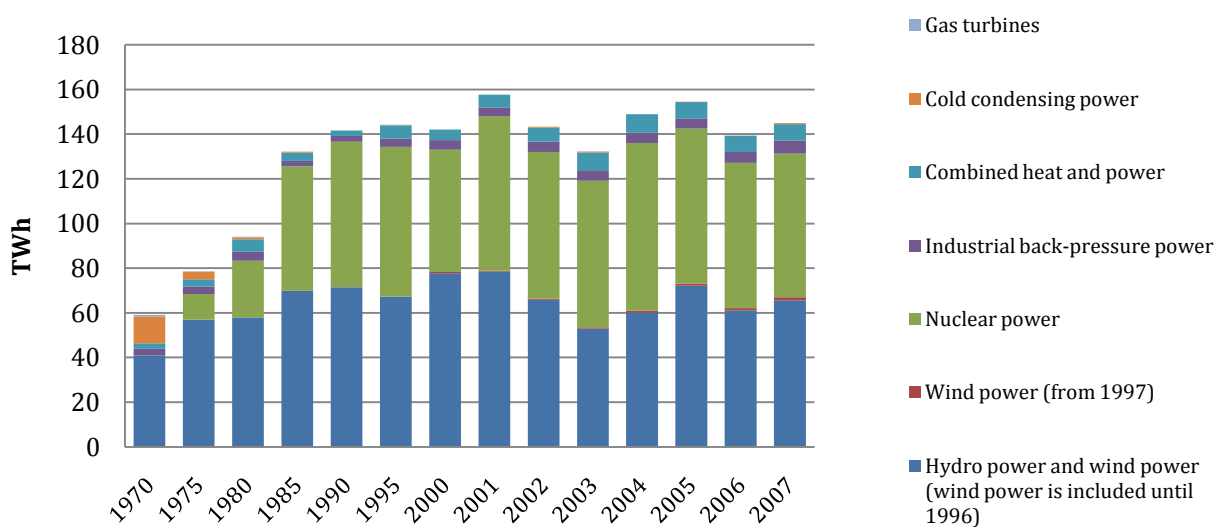

FIGURE 4: SWEDISH ELECTRICITY PRODUCTION 1970-2007. (ENERGIMYNDIGHETEN, 2008)

Sweden consumed in 2007 a total amount of 146.2 TWh. The population uses about 16 500 kWh electricity every year per person. By this, the Swedes are one of the top consumers of electricity in the world. This can be explained by many industries, cold climate, high level of buildings heated by electricity and a historic low electricity price. (Energimyndigheten, 2008)

There have been changes in the electricity business in recent years from national monopolies towards international businesses without monopolies, especially in the Nordic countries and EU. In the Nordic countries, a Nordic stock market handles the trade of electricity. All Nordic countries except Iceland uses this market, Nord Pool. The price of electricity in the Nordic countries is mainly set based on water flow in Norway and Sweden and nuclear power plant operations in Sweden and Finland. The rest of the world affects the price level considering the international price of fossil fuels and management control measure. (Energimyndigheten, 2008)

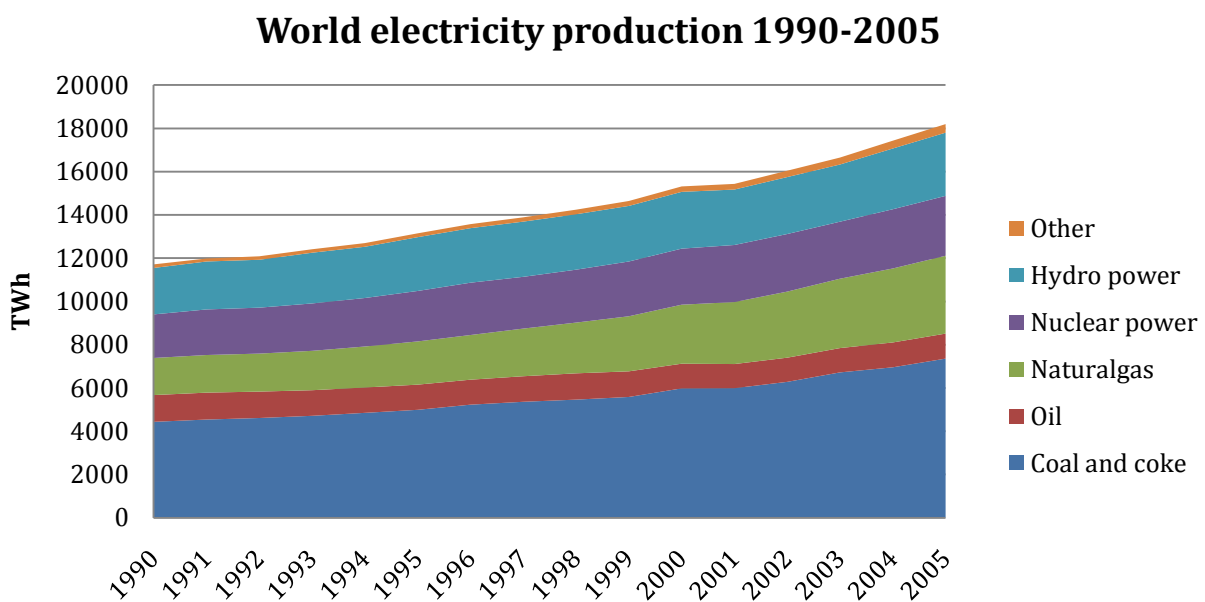

FIGURE 5: WORLDS TOTAL ELECTRICITY PRODUCTION 1990-2005. (ENERGIMYNDIGHETEN, 2008)

The electric energy production in the world 1990-2005 is visualized in Figure 5. Most of the electricity production remains from coal and coke, followed by natural gas. Hydropower and nuclear power have about the same production amount as natural gas. Oil and other types of energy sources are small parts of the electricity production. Comparing Figure 2 and Figure 5, it can be seen that energy extraction from oil is common, but only a small part of it is used for production of electricity. The use of electricity in different parts of the world is shown in Figure 6, where North America is the main user of electricity and Africa uses the smallest part of the total electricity. (Energimyndigheten, 2008)

## World electricity use 1990-2005

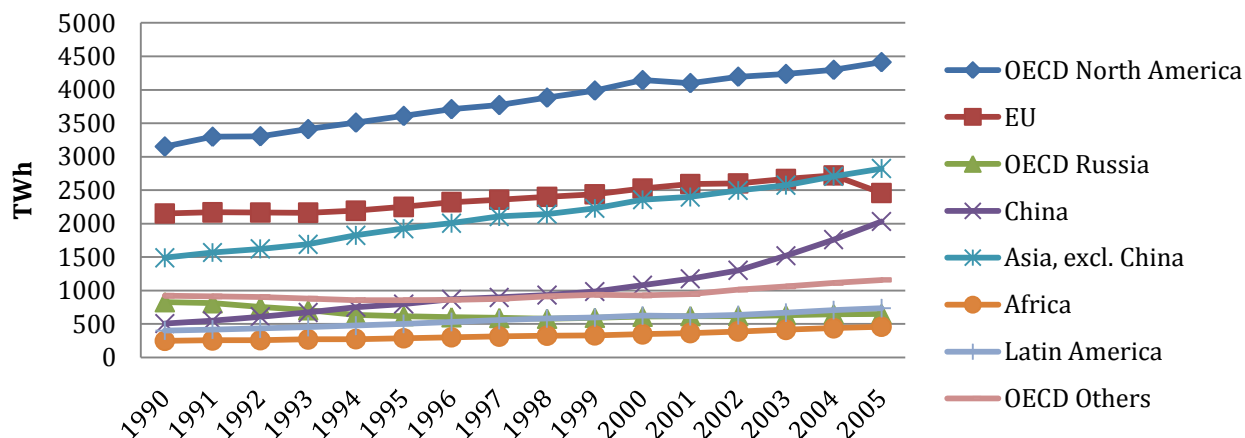

FIGURE 6: WORLD ELECTRICITY USE DEPENDING ON REGIONS. (ENERGIMYNDIGHETEN, 2008)

## RENEWABLE ENERGY SOURCES

The total share of renewable energy in Sweden is shown in Figure 7. In 1990, the total share of renewable energy was 33.9% and since then it has increased continually. In 2007, the renewable energy share reached 43.9%. According to the goal stated by EU, Sweden should have a total share of renewable energy sources of 49% in 2020. The use of electrical energy in Sweden is in general more environmental friendly than the use of energy for transports and heating, since almost half of the electricity production derives from hydropower. The transportation sector uses a very low share of renewable sources. By improving this sector with e.g. hybrid vehicles and plug-ins it could make a big difference to the environment. Sweden is the country in EU with the highest shares of renewable energy sources in comparison to power supply; it is one of the top four increasing its share the most during 2000-2005. (Energimyndigheten, 2008)

### Renewable energy supply in Sweden

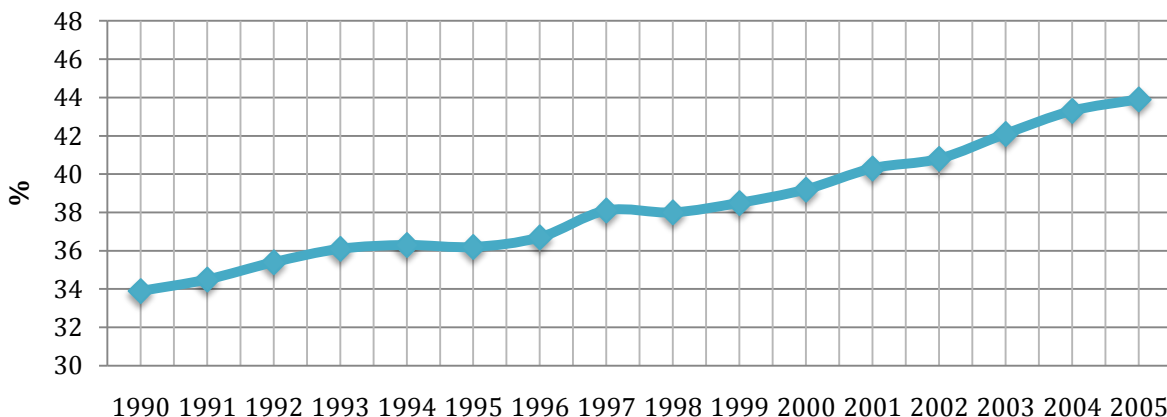

FIGURE 7: RENEWABLE ENERGY SOURCES IN SWEDEN. (ENERGIMYNDIGHETEN, 2008)

Even though renewable energy sources contribute the electricity production in Sweden, there are large possibilities to improve it even more. Wind power produced electricity keeps expanding in order to attain directives made in Sweden and EU to achieve a durable power system. (Energimyndigheten, 2008)

### Renewable energy supply in the world

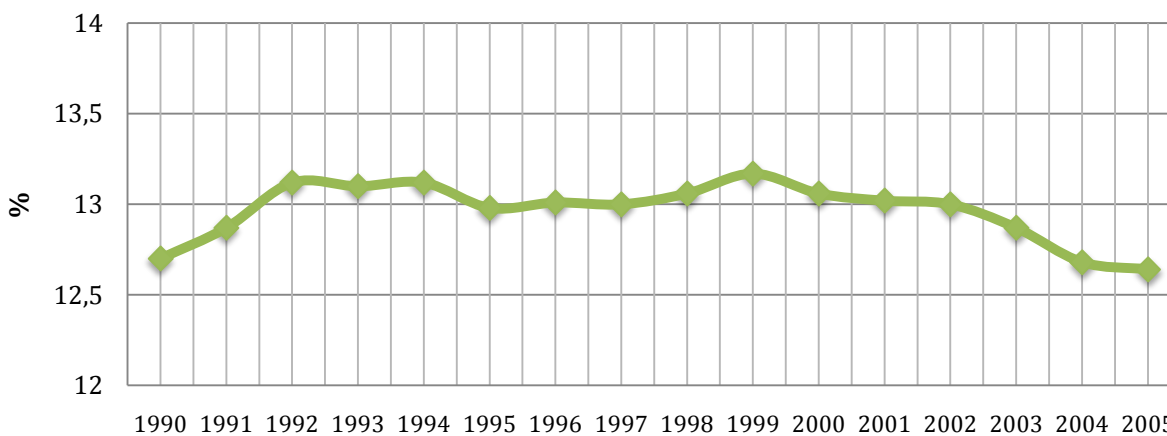

FIGURE 8: RENEWABLE ENERGY SOURCES IN THE WORLD. (ENERGIMYNDIGHETEN, 2008)

Total used energy in the world 2005 consisted of almost 13% renewable energy sources. This quantity has varied within the level of 12-13% in 1990-2005, shown in Figure 8. In Africa about half of the used energy is renewable, in Asia about one third, in Latin America about one fifth, in Russia less than 2% and in the Middle East it is less than 0.5%. (Energimyndigheten, 2008)

## Wind power in Sweden 1982-2007

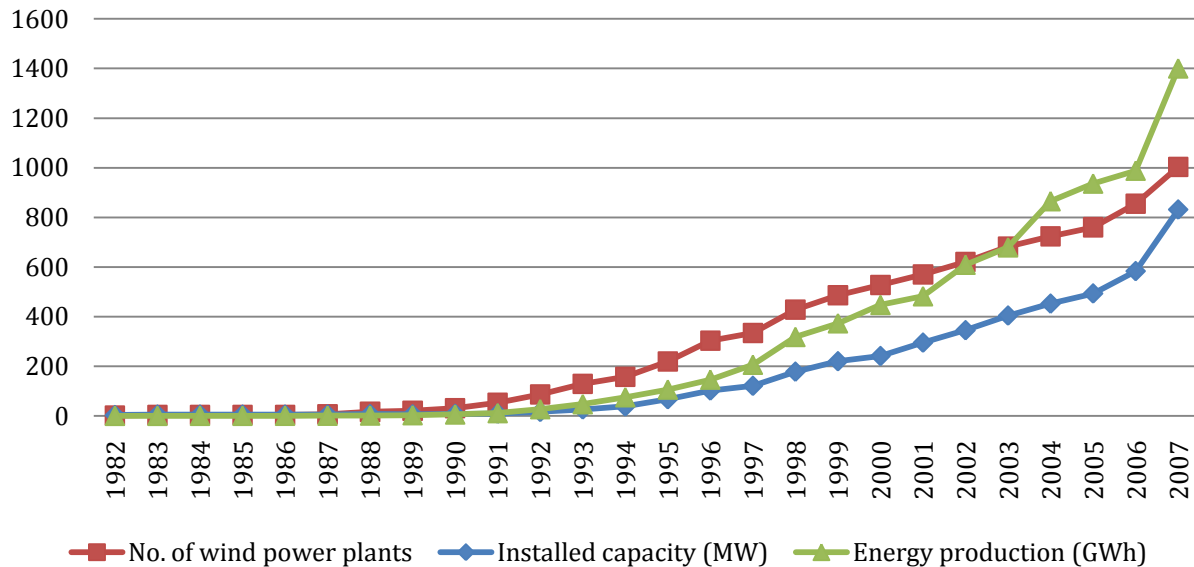

FIGURE 9: WIND POWER PLANTS IN SWEDEN, NUMBER OF THEM, CAPACITY AND POWER PRODUCTION. (ENERGIMYNDIGHETEN, 2008)

Electricity produced by wind power is strongly increasing all over the world. Figure 9 shows the expansion of wind power produced electricity in Sweden. Total amount of wind power plants, total installed capacity and energy production every year from 1982-2007 is also shown in the figure. The graph corresponding to capacity does not show newly installed, but total capacity. Since the wind speed is changing rapidly and it is not rated wind speed all the time, the actual energy production is shown in a separate plot. The y-axis has different meanings depending on the plots. For installed capacity, it is power [MW], for power production it is energy [GWh] and for installed wind power plants, it is the number of power plants. Since 1993, the wind power industry has expanded widely. The largest growth of expansion and production was in 2006-2007. In order for Sweden to reach the government proposal of 30 TWh until 2020, the expansion of wind power must increase even more. (Energimyndigheten, 2008)

## Total installed wind power capacity in the world

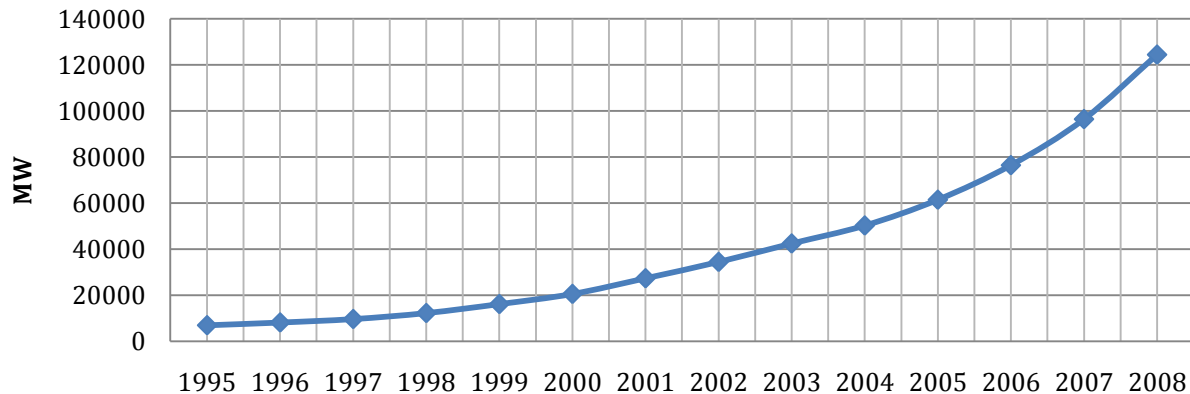

FIGURE 10: INSTALLED CAPACITY OF WIND POWER IN THE WORLD.

Figure 10 shows total installed capacity of wind power in the world 1995-2008. It has increased since 1995, but mostly since 2004. In 2008 it reached a capacity of almost 125 000 MW.

## WIND POWER GOALS IN SWEDEN AND WITHIN EU

The Swedish government made a proposal 2002, a goal solely for wind power of 10 TWh until 2015 was proposed. In 2007, the Energy authority proposed a new goal for wind power. The proposal was that 30 TWh of the energy production shall be produced by wind power in 2020, 10 TWh sea based and 20 TWh land based. (GothiaVind - Vindkraft)

Today, wind power plants produce about 1.4 TWh of the Swedish electricity, but the potential of an increased production is large. The goal provides a hint of the possibility of increasing power production from wind power plants. The actual expansion will probably be less than the proposed goal. (GothiaVind - Vindkraft)

A system, which promotes expansion of wind power plants in Sweden, is the system regarding electrical certificates. By this system, renewable energy producers receive an electrical certificate for every produced MWh electricity. In order for electrical certificates to be coveted, it is obligated for electricity suppliers and some electricity users to buy a certain amount of electrical certificates in relation to their electricity supply/use. By selling electrical certificates, the producers receive extra revenue besides incomes from electricity sale, which creates better economical conditions for an environmental friendly electricity production.



FIGURE 11: WIND POWER PLANTS ON NÄSUDDEN, SWEDEN.

There are proposals considering renewable energy production within EU as well. The wish is that 20% of energy production should be renewable in 2020. In EU today, 3.7% of the power production comes from wind power, and the goal to reach is 12-14% in 2020. (GothiaVind - Vindkraft)

China is the second largest energy user in the world. It has an installed wind capacity of 12 GW and aims to increase the capacity to 20 GW next year. In spring 2009, China renewed a wind power goal, set 18 months previously, of 30 GW to 100 GW installed wind power in 2020. Achieving this goal will involve a capacity eight times higher than in 2008. (Rujun Shen, 2009)

In the U.S. the goal is to reach 20 % produced electricity by wind power in 2030. This should be equivalent to 300 GW installed capacity. (U.S Department of Energy)



## CONSTRUCTION

There are many possibilities when designing a wind power plant i.e. if it should have vertical or horizontal axle, be located at land or sea, what kind of generator and control systems it should consist of. Figure 12 shows the different options.

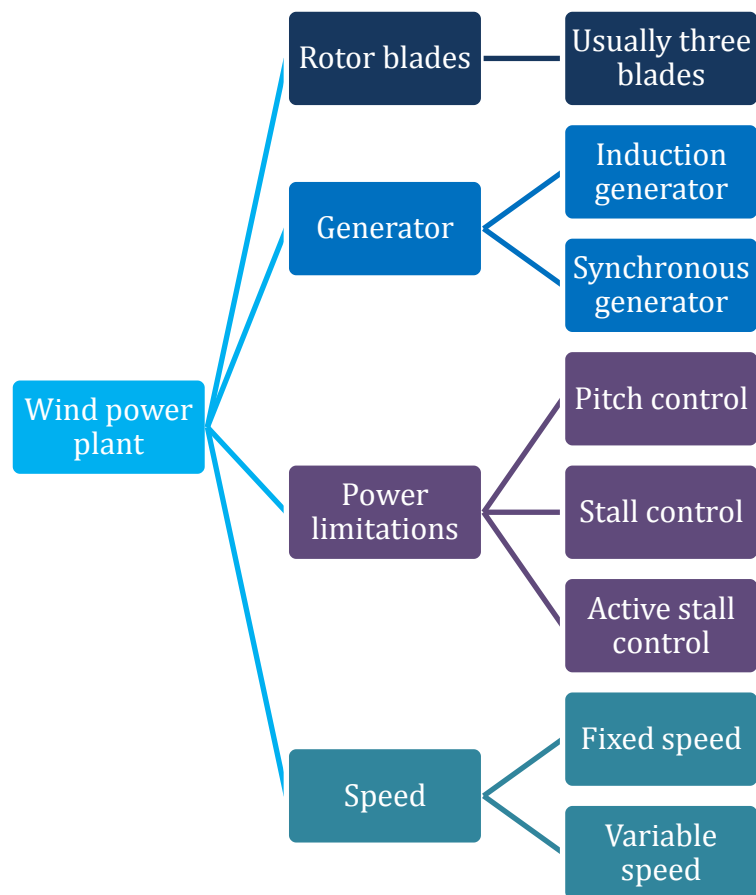

FIGURE 12: POSSIBILITIES OF COMPONENTS IN A WIND POWER PLANT.

Wind power plants create electrical energy from the kinetic energy in the wind. A wind power plant operates according to following principle:

1. The motion of the wind puts the turbine in motion.
2. A torque is created on the axis connected to the generator.
3. The generator transforms mechanical energy into electrical energy.

A wind power plant consists of a number of components, shown in Figure 13. The main components are foundation, tower, wind turbine and nacelle. The foundation gives stability to the plant construction. The tower is often created by steel and has the shape of a cone. Some fabricates has concrete as an

alternative material for the tower. The nacelle contains gearbox, generator and electrical equipment, and it turns towards the wind direction. There are several ways to design a wind power plant. Size of tower and rotor blades varies between different models and the electrical system can appear differently. (Wizelius, 2002)

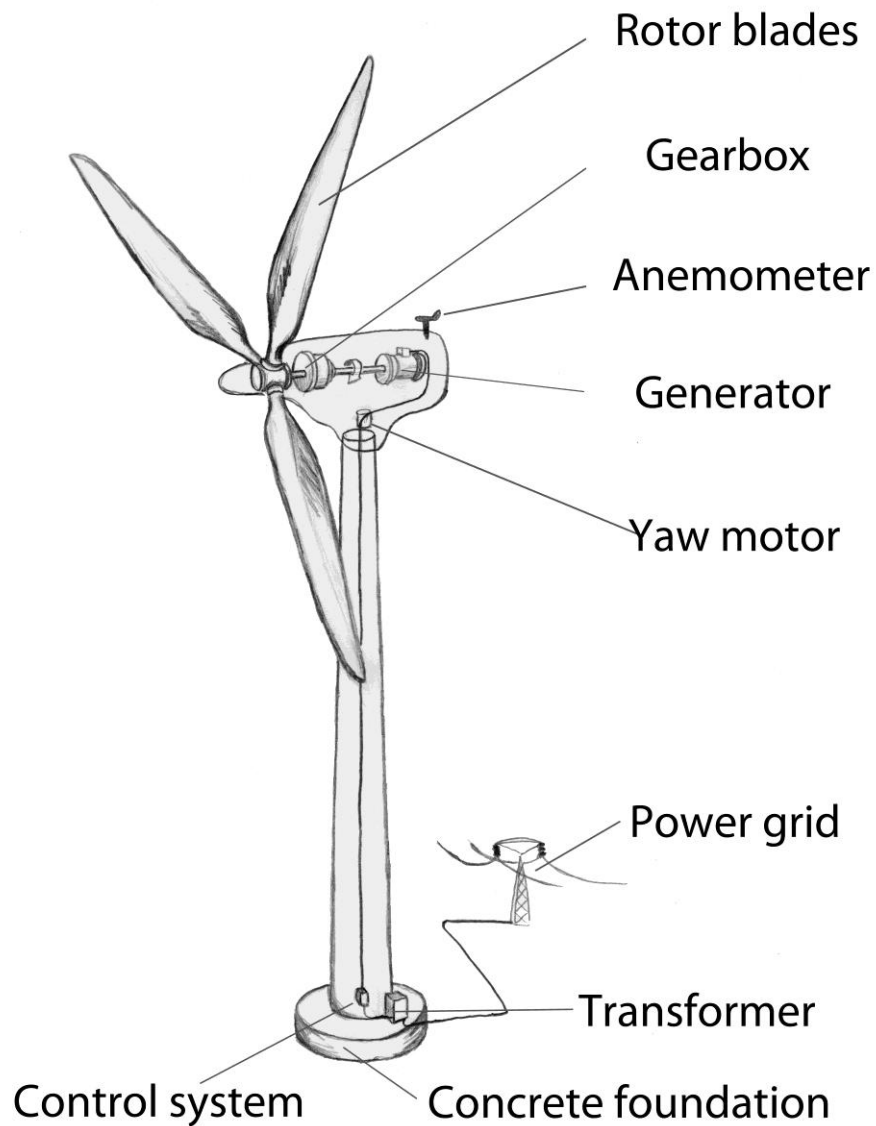

FIGURE 13: CONSTRUCTION OF A WIND POWER PLANT.

There are mainly two types of wind power plants, vertical axis wind turbines, VAWT and horizontal axis wind turbines, HAWT. The HAWT is the most commonly occurring type in Swedish landscapes. The turbine is constructed on a high tower, shown in Figure 14. This type is called HAWT since the axis between generator and turbine is horizontal to the ground. The HAWT dominates the wind power market today. (Wizelius, 2002)

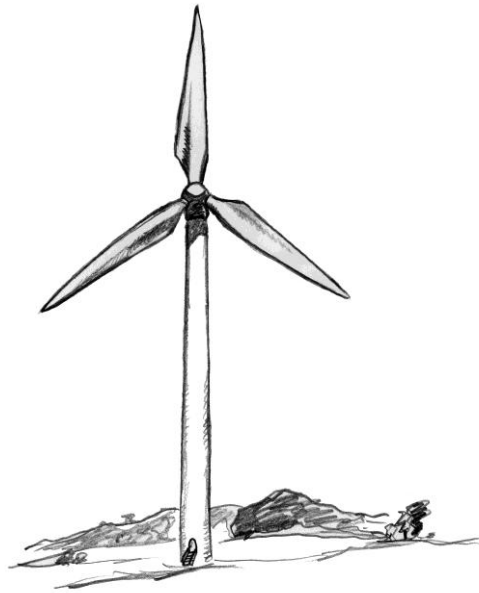

FIGURE 14: HORIZONTAL AXIS WIND TURBINE, HAWT.

VAWT exists in a smaller scale than HAWT and one model is shown in Figure 15. There are some advantages of these types of plants. The nacelle containing generator and gearbox can be placed on the ground, which makes it easier to maintain, compared to HAWT. Despite this, these kinds of plants are not developed well enough for the commercial market today, which is why only HAWT will be discussed continuously. (Wizelius, 2002)



FIGURE 15: VERTICAL AXIS WIND TURBINE, VAWT.

The rotor, also called turbine, consists of rotor blades and hub. Denmark is one of the leading countries in Europe in wind power and most of the wind power plants in Sweden are constructed after Danish design with three blades. This construction is the most common one, but other types have been tested in the past. The advantages of having less blades than three, two or one, is decreased material cost and weight. (Sidén, 2009)

Figure 16 present three types of wind power plants. When a two bladed wind power plant is not in operation it looks like a cross, which people does not find appealing. The wind power market aims to get people positive to the plants by trying to simplify the process of permissions, in order to expand the business. Three bladed plants appear more harmonic than two bladed plants in operation, since they are quieter and more aesthetical appealing. The efficiency is comparable among them, but three bladed wind power plants are more popular because of the appearance.



FIGURE 16: THREE TYPES OF HAWTS, SITUATED ON NÄSUDDEN, SWEDEN.

## HISTORY

---

Kinetic energy in wind power has been taken care of differently during history. Boats have been sailing over the world seas and grains have been grinded by windmills, to mention a few examples. Methods to produce electric energy from wind power have been used since the end of the 19<sup>th</sup> century, with an extensive development from small windmills to large wind farms.

### ENERGY HISTORY WITH FOCUS ON WIND POWER

---

Examples of different methods to extract energy in a lead period of more than hundred thousand years are shown in Figure 17. It begins with fire, animal muscles, sails, windmills and ends with modern wind power plants existing today.



FIGURE 17: DIFFERENT ENERGY SOURCES THROUGH TIME: FIRE, ANIMALS, SAILS, WINDMILLS AND WIND POWER PLANTS.

More than hundred thousand years ago, fire was used as the first energy source. It was, and still is, renewable since it came from bio energy. Although new energy sources came to existence, bio energy still was the most important energy source until the middle of the 20<sup>th</sup> century. Next step in the history of energy was animals with their muscle powers, used to simplify transports and work. Animals are still used in that purpose in many places of the world. (Sidén, 2009)

Wind power has been used differently in thousands of years. Small boats started to use helping sails to make longer transports easier e.g. along coasts or in rivers. Larger sails were developed and new opportunities opened up such as sailing around the world. (20th Century Developments, 2002)

Windmills became popular after the first millennium and were mostly spread in Asia and Europe. There are windmills with vertical- or horizontal axles. The vertical ailed windmill was invented in Persia during the second half of the first millennium A.D. In Europe, windmills with horizontal axle were built during the 12<sup>th</sup> century. They were often used to grind seed or to pump water. (20th Century Developments, 2002)



FIGURE 18: WINDMILL FROM ÖLAND, SWEDEN.

Windmills came to Sweden in the 14<sup>th</sup> century and spread over the country. On Öland, there were about 2000 windmills in the 19<sup>th</sup> century, examples are shown in Figure 18. In Figure 19, a horizontal axle windmill from the south of Sweden is shown. It is located in Särðal, Halland and has six floors and four grinding stones. This is one of the largest windmills in Europe. Before the steam engines invention, hydropower and wind power was roughly equally used to drive machines. (Sidén, 2009) (Särðals kvarn)



FIGURE 19: WINDMILL LOCATED IN SÄRDAL, SWEDEN.

During the 18<sup>th</sup> century, the steam engine was invented. It transforms heat to kinetic energy, which results in faster transports and paves way for the industrial revolutions advance. Development made the advantages of steam power ahead of wind turbines and water wheels. When the steam engine became small and movable, the steam locomobile was developed and it simplified work for agriculture and forestry, since horses was required to a less extent and sawmills could be placed even where hydropower did not exist. (20th Century Developments, 2002)

---

### WATER PUMPING WINDMILLS IN THE PRAIRIE IN USA

---

An important part of history, particularly in USA, was the origin of water pumping windmills that made the prairie inhabitable. The windmills usually consisted of a high post with a wind turbine attached on top, which drove a pump in a drilled cylinder in the ground. The location was close to the farm, partially because of being near the water, but also to have the wind wheel under supervision, not to break during heavy storms. Later, during 1854, when Daniel Halladay, developed windmills with automatic power regulation and four rotor blades letting some wind to pass by. These kinds of windmills could be used e.g. under heavier weather and therefore pump the water further away from the house. This made it possible to increase territory and cattle. The water pumping windmills popularity increased drastically and in the end of the 19<sup>th</sup> century, there were 77 companies selling them in different types and size. (Wizelius, 2002) (Association, 2003)

In the 19<sup>th</sup> century, water pumping windmills contributed to the expansion of railways since the trains needed to fill up the water reservoirs during the trip, to provide for the steam locomotives. (Wizelius, 2002)

---

### WINDMILLS GENERATING ELECTRICITY

---

The invention of steam engines resulted in less interest in windmills. To re-establish the interest, new areas of use had to be found. Two important pioneers within wind energy are the American Charles F. Brush and the Dane Poul la Cour, who developed electrical windmills in the end of the 19<sup>th</sup> century. Brush built the first automatically functional electric generating windmill in the world, during the winter 1887-1888 in Ohio. The windmill charged the batteries in his farm and was in operation for 20 years. Poul la Cour was a pioneer in modern aerodynamics and to perform experiments within the area, he built a wind tunnel. He worked as a teacher and was worried about energy storage. This resulted in construction of a windmill that generated electricity to produce hydrogen to the school's lamps. In the 1910s, hundreds of windmills operated in Denmark because of Poul la Cour. In other parts of Europe wind power plants were developed, but only until the 1960s when oil conquered the market. After the oil crisis in 1973, development of wind power re-established again. (20th Century Developments, 2002) (Association, 2003)

In the 1930s, windmills generating electricity in order to charge batteries became popular. In the cities, there were small distribution grids, but the demand for electricity in rural areas was not high until the breakthrough of domestic appliances and the transition from crystal receiver to radios with vacuum tubes. Farmers demanded more electricity and the production moved to the countryside. Windmills, usually called wind chargers, which charged batteries was a solution. This new windmill construction was inspired of the aircraft technology, with two or four rotors blades conformed after knowledge within the

aerodynamics and similar to the propellers of aircrafts. They worked principally like a converted aircraft propeller. Many years later, when the rural areas were connected to the transmission grid, the wind chargers were not used frequently anymore. (Wizelius, 2002)

## HISTORY OF WIND POWER PLANTS

Windmills generating electricity has existed since the end of the 19<sup>th</sup> century, but it is not until recently wind power plants have penetrated the electricity market. The power plants have varied in size, construction and capacity through time. Figure 20 visualize sizes of wind power plants different years, compared to buildings as Leaning tower in Pisa, Turning Torso in Malmö, Sweden and the Eiffel Tower in Paris, France. The question mark represents wind power plants under development. Today, newly installed large wind power plants usually have a rated power in the range 2-3 MW. (Boverket, 2009)

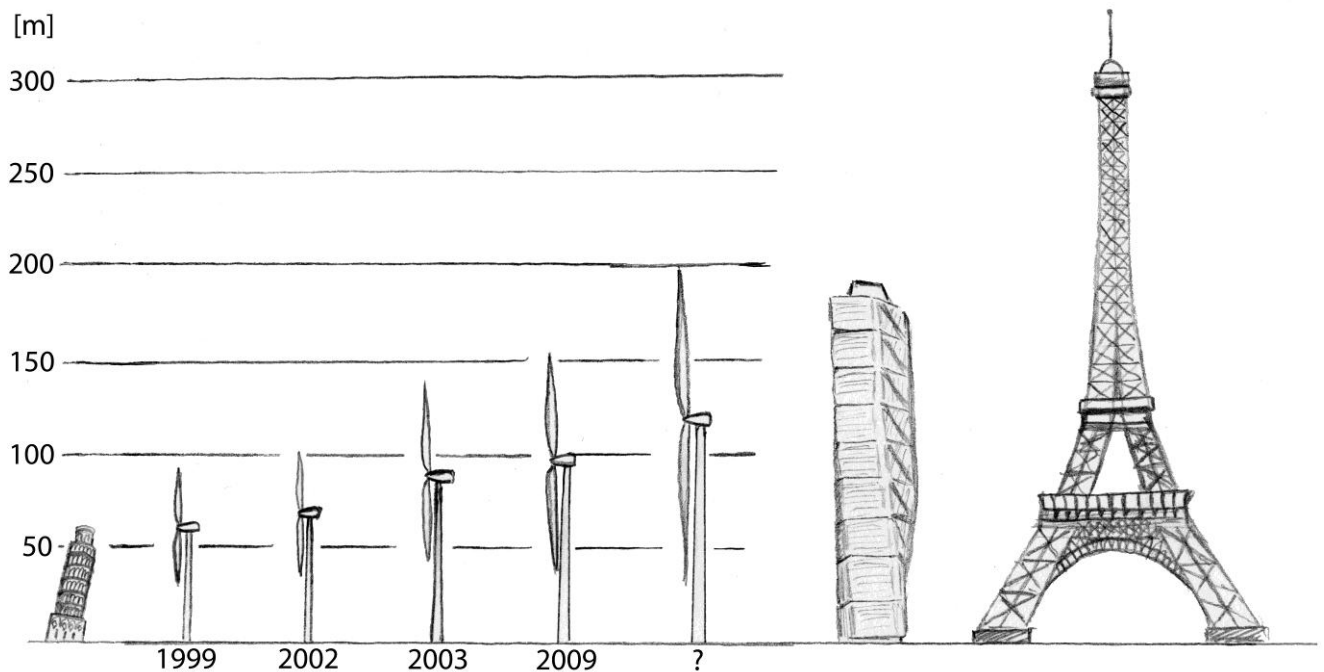

FIGURE 20: SIZES OF WIND POWER PLANTS COMPARED TO FAMOUS BUILDINGS.



Figure 21 presents an overview of development of wind power plants, starting with simple windmills grinding seed or driving machines and developing to water pumping windmills often located in the prairie. Later on windmills generates electricity and wind power plants and parks are constructed. Following text will describe important occasions in the history of wind power plants.

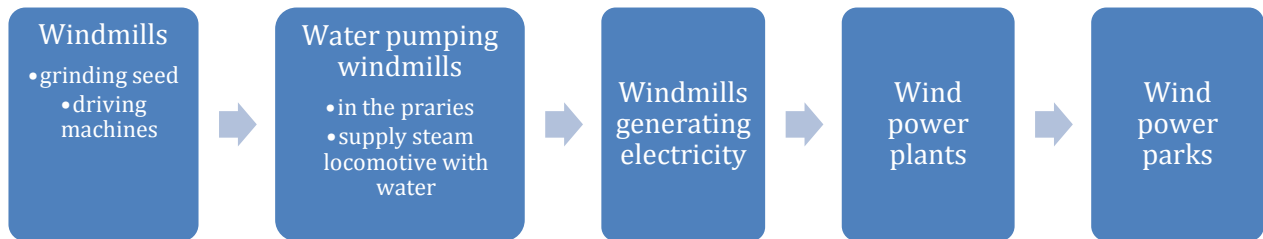

FIGURE 21: DEVELOPMENT OF WIND POWER PLANTS.

*1888* - Brush builds the first automatically working electric generating windmill in the world, during the winter 1887-1888 in Ohio. It is in operation for 20 years, charging the batteries of his mansion. Its rated value is 12 kW, it consists of 144 rotor blades with a diameter of 17 m and it is possible to turn it considering wind direction. (20th Century Developments, 2002)

*1891* - The Dane Poul la Cour develops the first windmill generating electricity with consideration to aerodynamic design principles. That involves a construction with four rotor blades designed after aircraft wings and with a rated value of 25 kW. (20th Century Developments, 2002)

*1908* - Denmark has 72 wind power plants each producing 10-20 kW (Wizelius, 2002)

*1931* - A large wind power plant with a 100 kW Balaclava generator is installed in Russia close to the Caspian Sea. It operates for two years and produces 200 000 kWh. (20th Century Developments, 2002)

*1930-1940, USA* - Energy needs increases among farmers in USA, because of a growing agriculture. The great depression in the end of the 1920s hits many countries hard, especially USA. This leads to an expanding of the power grid by the government, in order to supply energy for the increased demand and to stimulate the depressed economy. This leads to the possibility of a continued development of wind power plants. (20th Century Developments, 2002)

*1935-1970* - Many countries, e.g. Germany, Denmark, USA, France and Great Britain, performs researches about large-scale wind power. They agree that it should work, but none of them succeed with practical experiments. (20th Century Developments, 2002)

*1941* - The largest wind power plant ever for its time, a 1.25 MW Smith-Putnam, is installed in Vermont 1941. It is of a horizontal axis kind, two-bladed with a diameter of 53 m and a pitch control to maintain a generation of 28 rpm. In 1945, one of the rotor blades breaks, probably due to exhausted material. (20th Century Developments, 2002)

*After World War II* - The European development of wind power technology is once again on the market as the price of fossil fuel increased. At this time, the development focuses on to be able to connect the wind power plants to the power grid. (20th Century Developments, 2002)

1957 - The Danes develop a wind power plant, called "the Gedser Mill" connected to the grid, which operates until 1967. It is smaller than the one in Vermont, with a rated value of 200 kW and three fixed rotor blades with a diameter of 24 m. The plant is equipped with a technology with reinforcement between the rotor blades. (20th Century Developments, 2002)

1957-1968 - Ulrich Hutter from Germany is a pioneer within wind power technology. He develops many advanced horizontal axle windmills with blades of fibreglass and plastic. He uses variable pitch and allows the rotor to teeter in order to obtain a better durability. His construction results in high efficiency because of the light construction and variable pitch. (20th Century Developments, 2002)

1970s - The two previous examples cause big attention in the 1970s. The Gedser Mill is improved and the U.S. designers later use the German machines where the rotor hub could teeter. (20th Century Developments, 2002) In the end of the 1970s, the interest for wind power technology increases again, considering high prices of fossil fuel and recently occurring accidents in nuclear power plants. (Wizelius, 2002)

1979-1983 - Development and research about wind power is in progress. Näsudden, in the south of Gotland, Sweden has good wind conditions, which leads to construction of wind power plant prototypes. "Näsudden I", a wind power plant with enormous dimensions at its time has a maximum power of 2 MW. It has a rotor diameter of 75 m and a tower height of 77 m, and is taken into operation in 1982. (Vattenfall, 2008)

1997-2008 - Project Lillgrund, the first Swedish sea based wind power park carries out. Several of years passes before the construction of Lillgrund starts, since many permissions are required. In March 2006 – December 2007, the park is under construction and the opening takes place in June 2008. At this time, Lillgrund is the third largest wind power park in the world. Lillgrund generates electricity equivalent the consumption of 60 000 households yearly. (Vattenfall, 2009)

2002 - The Swedish government proposes a goal of producing 10 TWh within production of renewable energy in 2010 and 10 TWh within production of wind power in 2015. (GothiaVind - Vindkraft)

2003 - The electrical certificate is introduced in Sweden to stimulate usage of renewable energy sources. Energy sources that receives the certificate are wind power, some hydro power, wave energy, sun energy, burning of peat in combined power and heating and some bio fuel. (Boverket, 2009)

2006 - More than 93000 wind power plants are installed in the world. (Boverket, 2009)

2007 - The Swedish government proposes a new goal of 30 TWh wind power in 2020 with 10 TWh wind power plants located at sea and 20 TWh wind power plants located on land. (GothiaVind - Vindkraft)



FIGURE 22: A PART OF THE WIND POWER PLANT AREA NÄSUDDEN, SEPTEMBER 2009.

2008 - The wind power plant “Näsudden II” is demolished after operation during 14 years. At this time, the wind power plant has generated the most electricity (61.4 GWh) during its lifetime, in the world. A photo of the location Näsudden is shown in Figure 22. (Vattenfall, 2008)



## WIND

---

Wind is a renewable energy source and desirable for energy production. The kinetic power in the wind is absorbed by the wind turbine and turned into electrical power by the generator in the power plant. The maximum amount of power that can be produced by one power plant can be calculated by Betz law, explained later in this chapter. Besides having knowledge about the technical parts of a power plant, it is also of importance to considerate the wind conditions at the location when a wind power plant is constructed.



## WIND ENERGY

---

The sun is the source to life on Earth and the source to wind energy. The sun is heating up the Earth and the air around it differently depending on location. For example, the area around the equator is exposed to a large amount of heating energy from the sun. Basically, nature aims to become in the state of equilibrium, which is why air masses with different temperature and pressure are moving relative each other. When the sun heats the air mass differently around the world, the air masses are moving in order to achieve balance. This is what happens when the wind is blowing. This kinetic energy is a renewable source that can be taken care of in many ways e.g. with wind power plants. (Sidén, 2009)

## WIND POWER

---

Betz law gives maximum theoretical power that can be absorbed from the wind and transformed into electrical power. The actual power from the generator is lower, since losses occur in the transformation between mechanical and electrical energy. Losses arise in bearings, gearbox, generator and converter. The most effective wind power plants today have an efficiency of near 50%. The development of wind power today focuses on e.g. producing wind power plants that are cheaper, uses less material, operates

more reliable, are quieter, are more aesthetic appealing, easier to transport and to put together. (Sidén, 2009)

The rated power of the wind power plant,  $P_n$ , is generated at rated wind speed  $v_n$ . The power plant is designed to produce its maximum amount of power at this speed. The most common value of  $v_n$  is in the range between 12-15 m/s. The value is decided by the manufacturer, and the choice is done based on economical factors. At wind speeds higher than the rated speed, power limitation is necessary, since the power plant is incapable of generating powers higher than  $P_n$ . The main reason for not designing wind power plants for higher wind speeds is that the wind seldom is that strong. It is simply not profitable to design the electric system and shaft for wind speeds higher than 12-15 m/s. At the wind speed,  $v_{stop}$ , which usually is around 25 m/s, the turbine is stopped. Even if the wind is very strong, the forces of the plant are less when the power plant is stopped. The plant is designed to manage wind speed stronger than wind speed of a hurricane, up to 70 m/s. (Wizelius, 2002)

---

## BETZ LAW

---

When the wind passes the turbine, its speed will be reduced. After the wind has passed the turbine, it has less energy and lower speed than before the passage, which can be seen in Figure 23. The effective rotor area  $A$  of the turbine corresponds to the dotted circle in the figure. The wind power plant cannot absorb all kinetic energy in the wind, since it would be entirely calm behind the turbine if this was possible. It can be shown that the best exchange is when wind speed is one third after passing the wind turbine, compared to what it was before. (Carlson, 2002)



FIGURE 23: THE MASS FLOW RATE THROUGH THE TURBINE.

$$P_{turbine} = \frac{\dot{m}}{2} (v_1^2 - v_2^2) \text{ [W]} \quad \text{(equation 1)}$$

$\dot{m}$  = mass flow rate of the air [kg/s],  $v_1$  = Wind speed before the turbine [m/s],  $v_2$  = Wind speed after the passage [m/s].

Equation 2 shows an expression for mass flow rate of the air.

$$\dot{m} = \rho A v \text{ [kg/s]} \quad \text{(equation 2)}$$

$\rho$  = density of the air [kg/m<sup>3</sup>],  $A$  = area of the rotor blades =  $\pi r^2$  [m<sup>2</sup>],  $v$  = wind speed at surface  $A$  [m/s]

Gathered power by the wind turbine is described in equation 3:

$$P_{turbine} = Fv \text{ [W]} \quad \text{(equation 3)}$$

F is the braking force from the rotor, which decreases the wind speed from  $v_1$  to  $v_2$ . The braking force is given by equation 4:

$$F = \dot{m}(v_1 - v_2) \text{ [N]} \quad (\text{equation 4})$$

Equation (4) added to equation (3) results in:

$$P_{\text{turbine}} = \dot{m}(v_1 - v_2)v \text{ [W]} \quad (\text{equation 5})$$

Equation (1) added to equation (5) results in:

$$\frac{\dot{m}}{2}(v_1^2 - v_2^2) = \dot{m}(v_1 - v_2)v \text{ [W]} \quad (\text{equation 6})$$

Division of  $\dot{m}$  and extension with the complex conjugate  $(v_1 + v_2)$  gives equation 7:

$$v = \frac{1}{2}(v_1 + v_2) \text{ [m/s]} \quad (\text{equation 7})$$

Adding equation (7) in equation (2) results in:

$$\dot{m} = \rho A \frac{1}{2}(v_1 + v_2) \text{ [kg/s]} \quad (\text{equation 8})$$

Adding equation (8) in equation (1) results in:

$$P_{\text{turbine}} = \rho \frac{A}{4}(v_1 + v_2)(v_1^2 - v_2^2) \text{ [W]} \quad (\text{equation 9})$$

Equation 10 gives a simplified expression of  $P_{\text{turbine}}$ :

$$P_{\text{turbine}} = \rho \frac{A}{4} v_1^3 \left(1 + \frac{v_2}{v_1}\right) \left(1 - \frac{v_2^2}{v_1^2}\right) \text{ [W]} \quad (\text{equation 10})$$

A derivation of equation 10, with respect to  $\frac{v_2}{v_1}$ , results in a maximum when  $\frac{v_2}{v_1} = \frac{1}{3}$ . At this ratio, the turbine assimilates the optimal amount of kinetic power from the wind. One third of the wind energy passes the turbine without contributing to energy production. The maximum amount of power that can be absorbed by the turbine is given by equation 11.

$$P_{\text{turbine,max}} = \frac{16}{27} \frac{\rho}{2} A v_1^3 \text{ [W]} \quad (\text{equation 11})$$

Equation 11 is the theoretical expression, which corresponds to a ideal wind turbine where no losses are taken into account. The efficiency of the turbine is assumed to be 100%. (Carlson, 2002)



Analysis of  $P$  gives:

1. Wind power is proportional to the density of the air. Since the density is lower at high altitudes, the wind energy will be lower in places like mountains and similar places. The air density is also lower at high temperature. (Carlson, 2002)
2. Wind energy is proportional to swept rotor area. Large rotor area results in more energy. (Carlson, 2002)
3. Wind energy is proportional to  $v_{\text{wind}}^3$ . Because of this, it is important to choose a suitable place for the power plant. (Carlson, 2002)

### Summary

The power from a wind power plant is calculated according to the following formula:

$$P = \frac{1}{2} c_p \rho A v^3$$

Where:

$P$  = Wind power [W]

$\rho$  = Density of air [ $\text{kg}/\text{m}^3$ ]

$A$  = Wrapped rotor area [ $\text{m}^2$ ]

$v$  = Undisturbed wind speed [m/s]

$c_p$  = Efficiency coefficient =  $\frac{16}{27}\eta$ , where  $\eta$  = the efficiency of the turbine.  $c_p$  is usually between 0.4 – 0.5.

<i>Data from Chalmers wind power plant on Hönö</i>	
Turbine diameter	13.5 m
Hub height	18 m

TABLE 1: DATA FOR CHALMERS WIND POWER PLANT ON HÖNÖ.

Figure 24 shows the theoretical wind power curve and a curve measured from Chalmers wind power plant on Hönö, and data for it can be seen in Table 1. The theoretical curve increases with increased wind speed. The curve with measured values increases proportional to the wind speed, but when the rated wind speed is reached, the curve is held at a constant value. At this point, the turbine starts to limit the power.

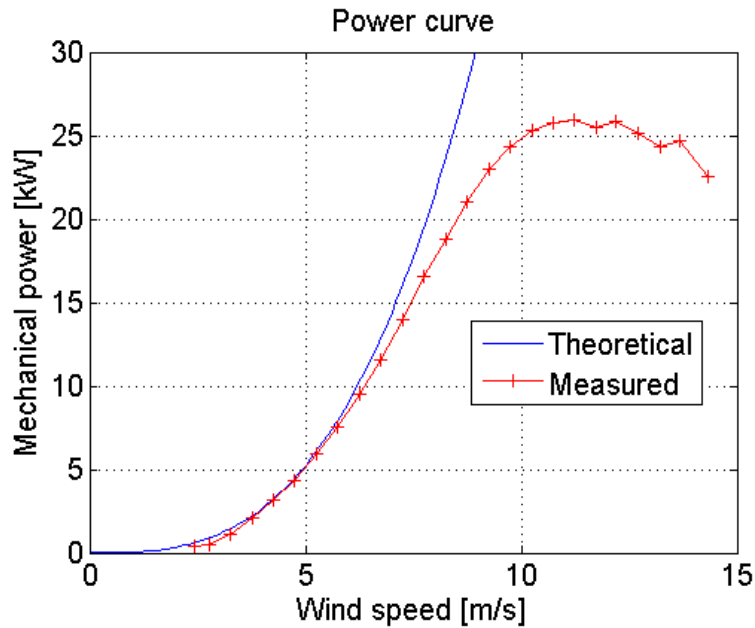

FIGURE 24: THEORETICAL AND MEASURED POWER CURVE FROM CHALMERS WIND POWER PLANT ON HÖNÖ, SWEDEN.

When a wind turbine is designed, the tip speed ratio  $\lambda$ , is an important parameter.  $\lambda$  is a measurement of how fast the blades rotate compared to the wind speed.

$$\lambda = \frac{v_{blade}}{v_{wind}} = \frac{\omega r}{v_{wind}}$$

Where:

$\lambda$  = Tip speed ratio

$v_{blade}$  = Tip speed of the blades [m/s]

$v_{wind}$  = Wind speed [m/s]

$r$  = Radius of the rotor [m]

$\omega$  = angular velocity [rad/s]

If the wind turbine rotates too slowly, most of the wind will pass the rotor without hitting the blades. On the other hand, if the rotor speed is too fast, the wind will have a hard time passing the rotor, since the rotating blades will act like a wall against the wind. Because of this, the wind turbine is designed according to an optimal value of the tip speed ratio, to extract a maximum amount of energy.

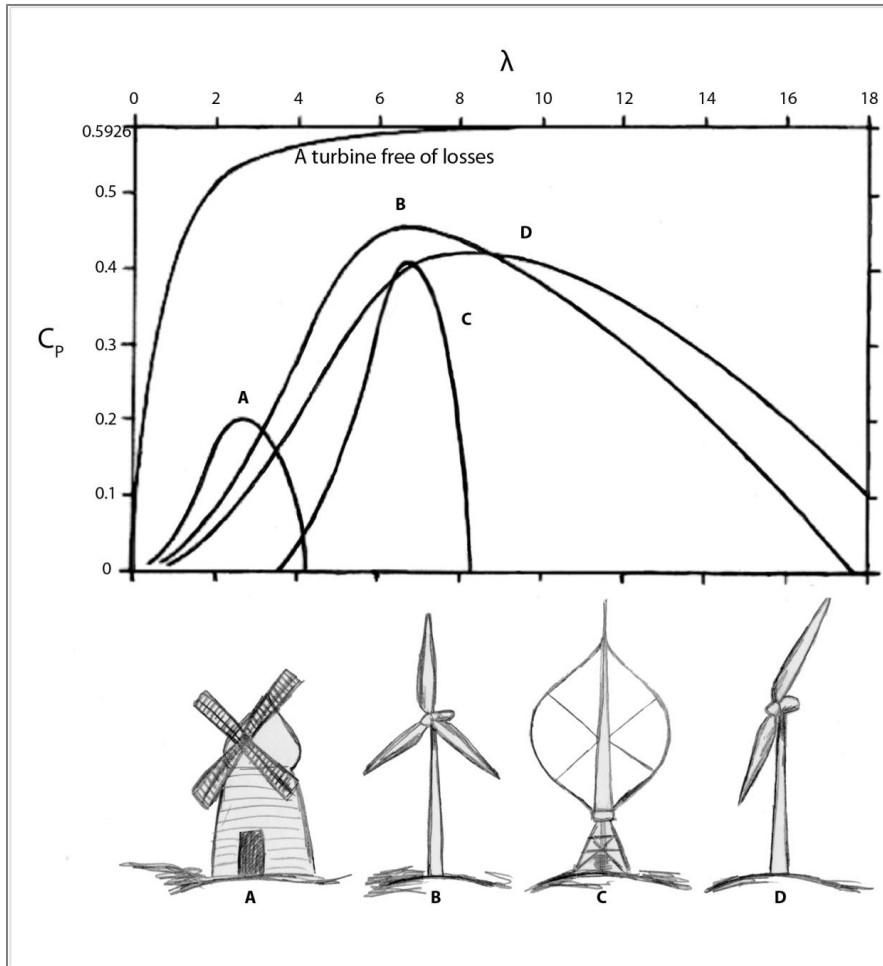

FIGURE 25: OVERVIEW OF DIFFERENT TURBINES AND THEIR APPROXIMATELY EFFICIENCY COEFFICIENT VERSUS TIP SPEED RATIO.

The optimal tip speed ratio depends on the number of blades of the wind turbine. The fewer blades, the faster must the turbine rotate in order to extract as much energy as possible. The efficiency of turbines with two blades is about the same as the efficiency of a turbine with three. Efficiency coefficients for different kinds of windmills are shown in Figure 25. Table 2 shows approximate optimal tip speed at different rotor blades. (Tip speed ratio, 2009)

<i>The number of rotor blades</i>	<i>Approximately optimal tip speed ratio</i>
2	6-9
3	5
4	3

TABLE 2: APPROXIMATE OPTIMAL TIP SPEED RATIO AT DIFFERENT NUMBERS OF ROTOR BLADES.

## PLACEMENT OF WIND POWER PLANTS

There are a number of factors that must be taken into consideration when the placement for a wind power plant is established. For example, the size of the power plant must be determined with respect to the height and rotor diameter. Since more energy to extract is available on heights, which can be seen in Figure 26, high towers are appropriate. Even more energy can be extracted when the rotor diameter is large. Nowadays, generators are well developed and must be provided with a large amount of wind energy in order to fully use their capacity. (Carlson, 2002)

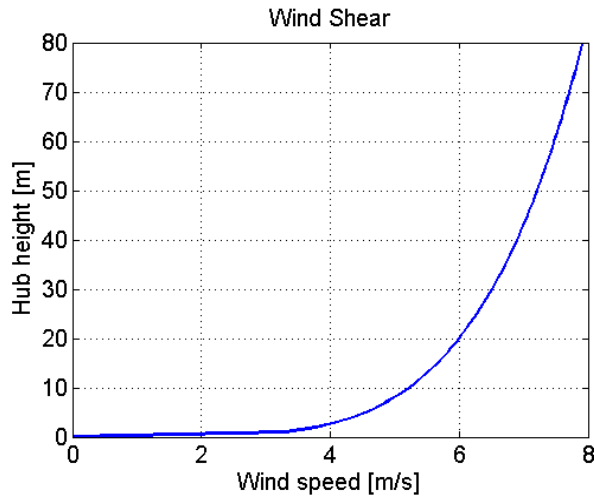

FIGURE 26: HUB HEIGHT VERSUS WIND SPEED.

Wind speed at the hub height often higher than wind speed at the anemometer. Usually the anemometer is at a height of 10 m. In comparison, the hub height usually is between 30-90 m. A model for estimating the wind speed at different hub heights with data from the anemometer, is given in following relation:

$$\frac{\bar{w}}{\bar{w}_0} = \left(\frac{h}{h_0}\right)^a$$

Where:

$\bar{w}$  = average wind speed [m/s]

$\bar{w}_0$  = wind speed at anemometer  $h_0$  [m/s]

$h$  = hub height [m]

$h_0$  = height at anemometer [m]

$a$  = wind shear exponent

Wind power plants should not be placed too close to each other, since the wind that passes the turbine must recover after the passage. A certain distance is necessary for the wind to contain the same amount of energy as before passing the turbine. If the distance is too small between two wind power plants, the power plant behind the first one will not be met by the same energy, and less energy can be extracted. Usually a distance of 7-10 turbine diameters between the plants is used. Figure 27 shows placements of plants within a wind farm in Falkenberg. (Carlson, 2002).



FIGURE 27: PLACEMENT OF WIND TURBINES WITHIN A WIND FARM IN FALKENBERG, SWEDEN.



## CONSTRUCTION OF THE POWER GRID

---

The power grid is divided into different levels with transmission grid, region grid, distribution grid and consumption. The transmission grid has the highest voltage level, in order to lower losses during long transportations, and the lines feeding private households have the lowest level. It is important to take into consideration possible faults appearing on different locations in the power grid. That is why it is constructed differently in the levels in order to keep good reliability and quality of grid and power. Figure 28 is a map over the Nordic transmission grid.



FIGURE 28: THE NORDIC TRANSMISSION GRID.

## THE SWEDISH POWER GRID THROUGH TIME

---

In the end of the 19<sup>th</sup> century, an expansion of the power grid in the cities started. Later on, the expansion reached the countryside as well. In the childhood of electricity, electric power was produced for industrial supply only and in some cases for households near the industries. The electricity in the households was mainly used for lamps. The first power grids were small and provided by one power plant alone. Different power grids had different frequencies, since no standard for electricity generation existed. It was not until the 1930s, two larger grids were built with a voltage level at 130 kV. One was located in southern Sweden and one in northern Sweden. (Elteknik)(EMC, elkvalitet och elmiljö, 2007)

When hydropower expanded in Norrland, in the north of Sweden, the voltage level of 130kV was not high enough for the power transportation to southern Sweden, where the main consumption was located. Since high power losses would be the result of power transportation at this voltage level, it was necessary to increase the voltage level. This was done in 1936, when the power grid was reconstructed to 220 kV instead of 130 kV. Hydropower continued to expand and in the 1950s, which resulted in a need of an even higher voltage level at the transmission grid. In 1952 was Sweden the first country in the world to use a 400 kV transmission line. The line went from Harsprånget to Hallsberg, which is a distance of 1200 km. Today, 400 kV is the main voltage level in the transmission grid. Still, 220 kV transmission lines are often used in Norrland in northern Sweden.(EMC, elkvalitet och elmiljö, 2007)



FIGURE 29: OVERHEAD LINES IN NORTHERN NORWAY.



## STRUCTURE OF THE POWER GRID

---

Generally, power grids are constructed with three phases for power transmission. Three phases involves three parallel wires, which together forms power lines. One of the reasons for a three-phase system is mainly a decreased total cost compared to one phase only. Another advantage with three phases is the constant amount of transferred power. In single-phase systems this amount is varying due to AC. As earlier mentioned, the transmission grid is divided into sub-grids with lower voltage levels. In order for this to be possible, transformers are used between the voltage levels. These are placed in sub-stations, where the electricity is redirected and passed on into sub-grids. A sub-station consists mainly of conducting rails to connect transformers, transmission lines and other electrical equipment. Every line and component is equipped with circuit breakers in order to disconnect the line or electrical component during fault or repair. It is very important that the power grid is reliable, since a power interruption or a breakdown in the power grid is a serious problem. The reliability is about 99.99%. Faults do occur sometimes in the grid, but these are often discovered by advanced protection and the component exposed to the fault can often be disconnected without causing interruptions. (Elteknik)

## POWER TRANSMISSION WITH DIFFERENT VOLTAGE LEVELS

---

The reason of the different voltage levels in the grid is the ambition of reaching optimal transmission of the power. The power transfers at high voltage and low current or low voltage and high current. The balance is determined by high resistance losses and/or high costs on sub-stations and circuit breakers. A high voltage level is used at long transports, which results in thinner wires, as the current is low. In this case the power losses are low but instead the electrical equipment is more expensive due to the high voltage. When a low voltage level is used, as in cases of short transports, the lines are thicker since they are exposed to higher current. This increases the cost of lines and results in higher power losses. On the other hand, the cost of electrical equipment such as circuit breakers and insulation are lower. (EMC, elkvalitet och elmiljö, 2007)

## DIFFERENT GRIDS WITHIN THE POWER GRID

---

The Swedish power grid is divided into different levels, shown in Figure 30. The Swedish authority Svenska Kraftnät, SvK, is the owner of the transmission grid, which reaches all the way from north to south of Sweden. The transmission grid splits into smaller grids, which are the region grid, distribution grid and power lines feeding private households and smaller industries. The different grids all have different voltage levels, where the highest voltage is in the transmission grid and the lowest voltage level is near private consumers. (Elteknik)(EMC, elkvalitet och elmiljö, 2007)

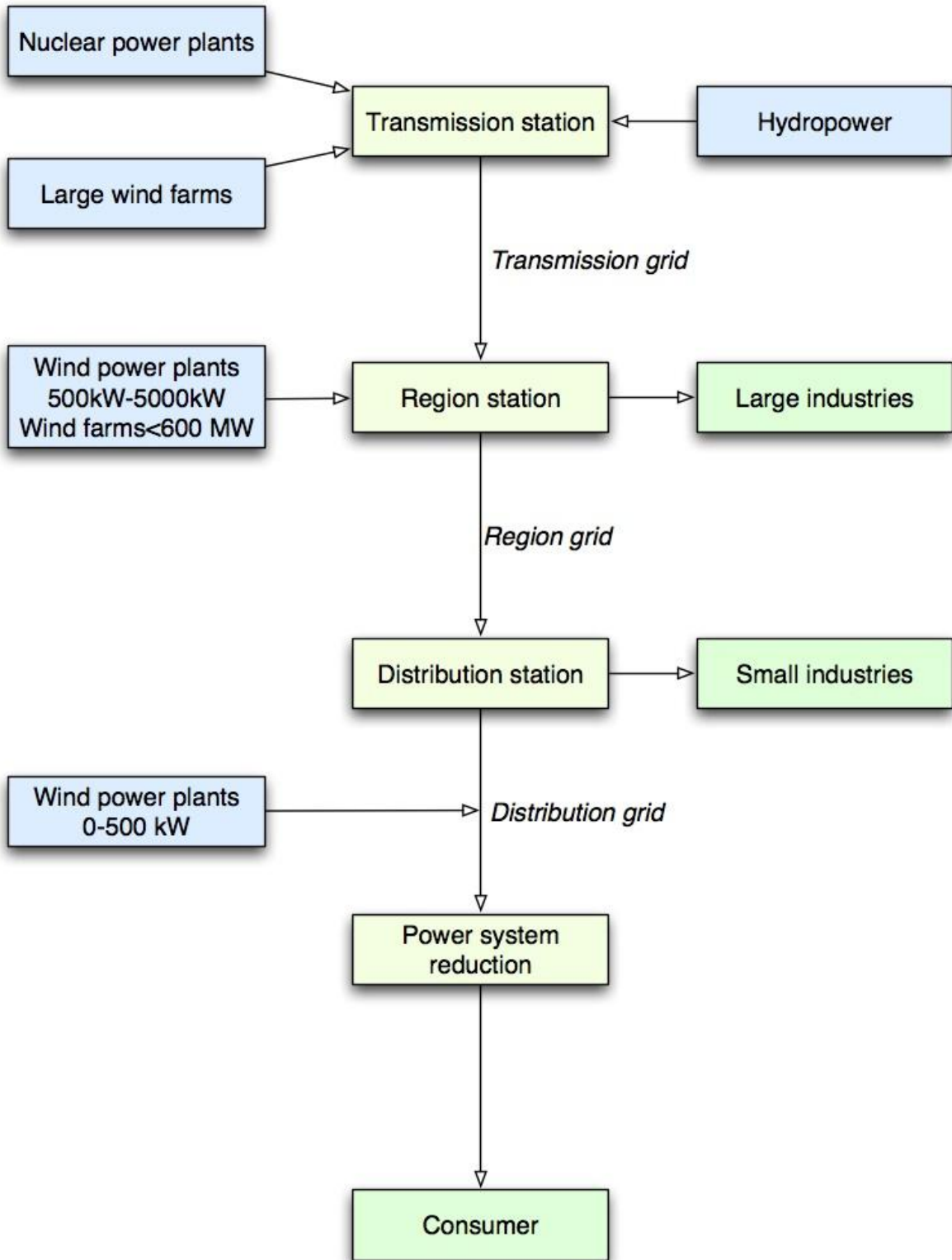

FIGURE 30: STRUCTURE OF THE POWER GRID.

---

## TRANSMISSION GRID

---

The transmission grid connects region grids and all large power plants, such as nuclear power plants, hydropower and large wind farms, as shown in Figure 30. It generally transports electricity long distances, which demands high voltage level. Usually 400 kV is used in order to eliminate power losses. Still 220 kV are used in many places in especially northern Sweden. (EMC, elkvalitet och miljöö, 2007)

---

## REGION GRID

---

The region grid divides the electricity within a region. The transportation distance is usually around 100 km and a voltage level of 130 kV is most commonly used. Voltage levels at 50 kV or 70 kV exists also in the region grid. The grid is loop-shaped and connected to the transmission grid in more than one point. There is a certain purpose of the shape. In this construction, lines can be disconnected during fault without interrupting the power flow, since power is still provided from another part of the grid. Larger industries and smaller power plants are connected directly to the region grid, as shown in Figure 30. (EMC, elkvalitet och miljöö, 2007)

---

## DISTRIBUTION GRID

---

The distribution grid divides the electricity within a smaller area. Power is transported stretches of about 10 km at a voltage level of 10 kV - 20 kV. The distribution grid consists of closed loops that are fed from two ways. Smaller industries usually receive their power supply from the distribution grid and small wind power plants are connected to it, as shown in Figure 30. In population centres ground buried cables are used. Since it seldom occur faults in cables, they are only fed from one direction. When private households experience faults, it is most likely that the fault has occurred in the distribution grid. Requirements for the reliability are not as high regarding the distribution grid, as it is regarding grids of higher level. The reason for this is that fewer consumers are affected by faults in distribution grid, compared to the region grid or transmission grid. (Elteknik)

---

## CONSUMPTION

---

Consumption is the last step. The electric power transfers about 1 km before it reaches the households. The voltage level for consumers is 400 V but voltage in regular electric sockets is 230 V, since one phase is used instead of three. Table 3 shows a summary of different power grids and their most common voltage level. Several lines are used in parallel when transferring more power than one line can handle. (Elteknik)

<i>Name of power grid</i>	<i>Voltage level [kV]</i>	<i>Transferred Power [MW]</i>
Transmission grid	400	1000
Region grid (subtransmission grid)	130	100
Distribution grid	10	10
Consumption	0.400	0-1

TABLE 3: A SUMMARY OF SWEDISH POWER GRIDS.

## POWER LIMITATIONS OF WIND POWER PLANTS

The wind that drives the rotor blades of a wind power plant, also press the whole plant backwards. If this force gets too high, the components of the plant might be overloaded and eventually the wind power plant could break down or in a worst-case scenario fall over. A wind power plant has to tolerate heavy storms and other types of rough weather. By power regulation, it is possible to limit the power output from the wind when the wind velocity is too high. Limitation of the power usually starts when the wind velocity is 12-14 m/s and when it is storm at around 25 m/s, the wind power plant turns off to avoid overloading. Three methods, to regulate power, are stall control, pitch control and active stall control. Figure 31 shows the basic function of pitch control and stall control, where the rotor blade is in sectional, surrounded by wind.(Ackermann, 2005)

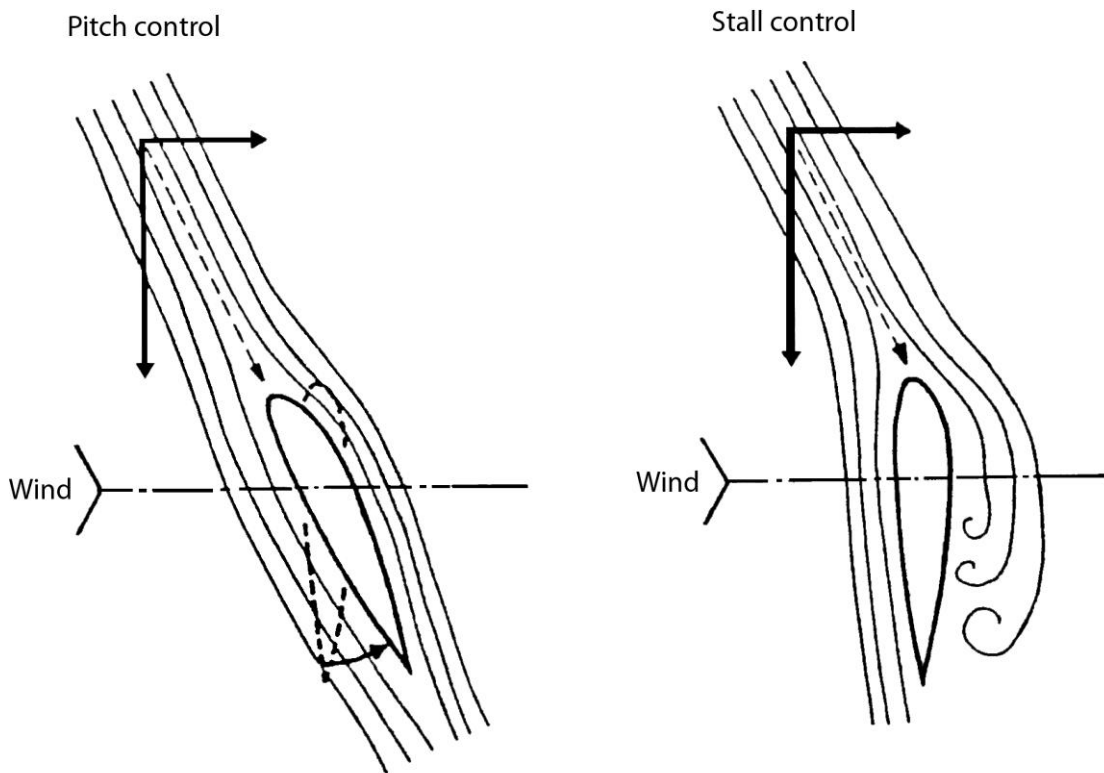

FIGURE 31: PITCH CONTROL AND STALL CONTROL

## PITCH CONTROL

---

When pitch control is used, the blades are turned to or against the wind depending on a large or small power output. Figure 32 shows a photo of the pitch construction inside the machinery. Advantages with this power regulation are good control over the power output as well as the possibility of an emergency shutdown if needed. From an electric perspective, a good output power control means that it is easier to regulate it to be close to the nominal power of the generator. Some disadvantages are the more complicated construction of the system with pitch gadgets and the possibility of high fluctuations in the power output when the wind speed varies fast. If the wind varies fast, the power limitation varies fast with this method. (Ackermann, 2005)



FIGURE 32: PHOTO TAKEN INSIDE THE MACHINERY OF A PITCH CONTROLLED WIND POWER PLANT.

## STALL CONTROL

---

Stall control is the simplest and most robust method to regulate the power from a wind turbine. The blades have a fixed angle and are set into a hub. They are designed to slow the turbine down if the wind velocity exceeds a certain value and the aerodynamic force on the blades will then decrease. The rotor blades have a profile that creates turbulence on its upper side when the wind blows too strongly. It is not possible to manufacture rotor blades that give a stall limitation exactly when nominal power is reached. Instead, the stall effect increases gradually from 8-9 m/s up to nominal wind speed. At nominal or higher wind speeds, a total power limitation is reached. When a wind power plant has a fixed rotation speed, there is no need for adjustment of the rotor blade angle. In this case the rotor speed increase proportionally with wind velocity, which results in an optimal angle. This kind of control is fairly slow and there will be less power variations compared to pitch control, which is a faster method. There are some

disadvantages with stall control e.g. the power production are low at low wind velocities and there are variations of the maximum steady-state power due to variations of air density, and temperature. For occasions when the wind turbine goes to over-speed and must be stopped, the rotor tips are designed with a brake, shown in Figure 33.(Ackermann, 2005)



FIGURE 33: WIND TURBINE WITH STALL CONTROL AND WITH RELEASED TIP-BRAKES.

---

### ACTIVE STALL CONTROL

---

With the active stall control, the advantages of both stall control and pitch control is offered. The rated power level can be tuned in precisely, due to the pitch-controlled blades, without being affected of the difference in air density or wind speed since stall control is also used. Typical for the stall control is uncertainties in the rated power level, which also can be avoided because of the pitch-control. Besides providing power control, the blade pitch system can also be used to accelerate the blades from idling to operational speed and bringing the rotor back to a safe idling situation in case of a grid loss or any other functional error, such as aero-braking.(Turbowinds, 1999)

The different methods are chosen depending on the type of the wind power plant. Pitch control is regularly used when the wind power plant is constructed with variable speed. Stall control and active stall control are most commonly used with fixed rotor speed.(Ackermann, 2005)





---

## ROTOR SPEED OF A WIND POWER PLANT

---

There are two possibilities of rotor speed within a wind power plant, fixed and variable speed. The simplest and oldest technology is the robust system of wind turbines with fixed rotor speed where the maximum power generation is reached at a certain wind speed. Later on, wind turbines with variable rotor speed were developed, which introduced a possibility for wind power plants to operate at maximum efficiency at different wind speeds.



---

### FIXED ROTOR SPEED

---

In the beginning of the 1990s, the standard way to construct wind turbines was with fixed rotor speed. This means regardless of the wind velocity, the rotor speed is fixed and determined by power grid frequency, gearbox and generator design. Wind turbines with fixed rotor speed are mostly equipped with induction generators, directly connected to the power grid, with a soft starter and capacitor bank in order to reduce the in-rush current and compensate for the reactive power. (Ackermann, 2005)

Early models of wind power plants are designed to reach maximum power generation at a certain wind speed. To increase power production, generators in some power plants consist of two sets of windings. One winding used at low wind speeds, with typically eight poles and one set of windings used at high wind speeds, with typically four to six poles. Advantages with a wind turbine with fixed speed are the robust, simple and reliable performance. The system is well tested and costs for electrical components are low. Disadvantages are the non-controllable consuming of reactive power, mechanical stress and limited control of power quality. Due to the fixed rotor speed, all variations in wind velocity is transmitted to the mechanical torque and the result is variations of power output to the grid. If the power grid is weak this variations may lead to large variations in voltage. (Ackermann, 2005)

## VARIABLE ROTOR SPEED

Today variable rotor speed is dominating the market of installed wind turbines. They are designed to reach maximum power output over a large interval of wind velocities. With variable rotation speed, it is possible to continually adjust the rotor speed  $\omega$  after wind velocity  $v$ . In this way, the tip speed ratio,  $\lambda$ , is kept constant at a pre-settled value corresponding the maximum power coefficient. (Ackermann, 2005)

The electrical system of a wind turbine with variable rotation speed is more complicated compared with turbines with fixed speed. A typical case is that the wind power plant is equipped with an induction generator and is connected to the grid through a power converter. The power converter controls the generator speed. Power variations caused by changes in wind speed is primarily absorbed by changes of the generators rotation speed and the rotor speed of the wind turbine. (Ackermann, 2005)

Advantages with variable rotation speed are higher efficiency, better power quality and less mechanical stress on the wind turbine. Disadvantages are losses due to power electronics, larger equipment and more expensive power electronics. (Ackermann, 2005)

Figure 34 shows power output versus wind speed of two types of power plants, one from a wind power plant with variable speed and one with fixed speed. The power plant with variable speed is regulated to keep rated power output when the wind speed is higher than rated wind speed. The stall controlled fixed speed wind turbine cannot be regulated that way, which lead to a decreased power output after passing rated wind speed. At 25 m/s the wind power plant is turned off.

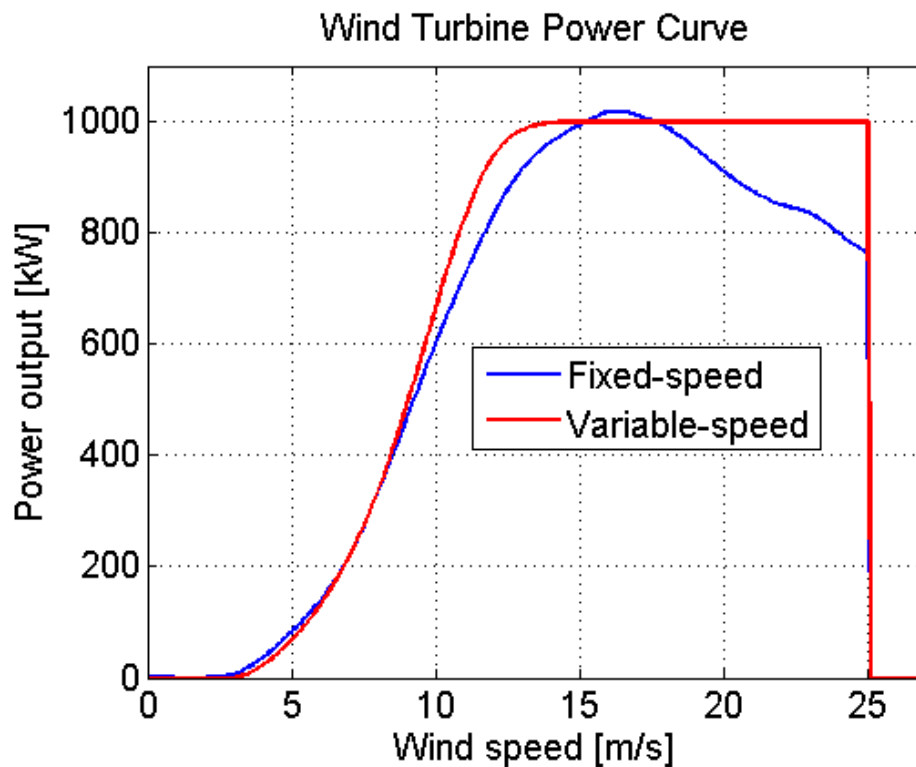

FIGURE 34: FIXED AND VARIABLE SPEED.

## ELECTRICAL SYSTEM

---

Electrical systems in wind power plants can appear in several ways. Components are chosen with aspect to generator type in order to achieve an efficient, robust and trustworthy wind power plant. Different components are used in different types of wind power plants. The electrical system of a power plant with variable rotor speed differs from a power plant with fixed rotor speed.

### COMPONENTS

---

A *thyristor* is an electric component that consists of a semiconducting material. The symbol is same as for a diode, but with an extra entrance on the side, called gate. Normal state for a thyristor is off, but a small current pulse at the gate electrode triggers it into conducting mode. The component is still conducting when the signal is removed. It returns to a blocking state when the current falls below a certain minimum or when the current changes direction.

The thyristor is a suitable switch component in power electronic circuits. It can block high voltage levels of several thousand Volts in blocking mode. It also conducts currents of sizes up to thousands Amperes, without causing any large voltage drops. The largest advantage with the thyristor is the possibility to control the component. It starts to conduct when it is desired. Despite this, the thyristor has a grand disadvantage when using it in switch-mode application, it is impossible to turn off. (Mohan, 2003)

The *gate turn off thyristor*, GTO, see Figure 35, has more benefits compared to a regular thyristor. It has all the advantages of a thyristor and also allows a turn-off, when a signal is added to the gate.

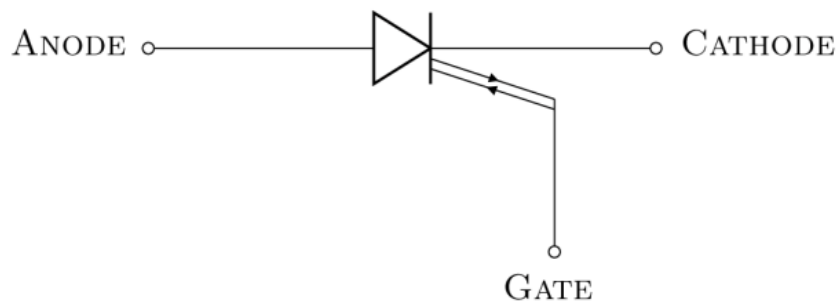

FIGURE 35: SYMBOL OF A GATE TURN OFF THYRISTOR, GTO.

Two types of *transistors* are *bipolar junction transistor*, BJT, and *MOSFET*. The BJT has low losses when it conducts, especially in circuits with high voltages, but it switches slowly. The MOSFET is turned on and off faster, but the losses are larger, especially for circuits created for high voltages as a couple of hundred Volts or more. Because of their properties, a combination of both types of transistors would make it possible to use all the good characteristics simultaneously. Experiments have resulted in development of an *insulated gate bipolar transistor*, IGBT, shown in Figure 36. (Mohan, 2003)

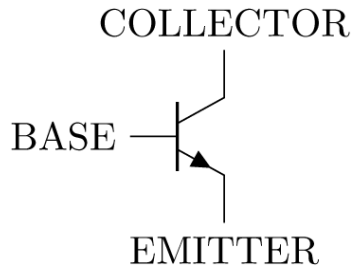

FIGURE 36: SYMBOL OF A INSULATED GATE BIPOLAR TRANSISTOR, IGBT.

The transistor demands a continuous signal on the gate. It conducts as long as there is a voltage on the gate, and stops when the voltage disappears. IGBT has higher switching frequency than GTO, which is why GTOs gradually is replaced by IGBTs.(Manwell, 2002)

---

### SOFT STARTER

---

The task of a soft starter is to limit the high in-rush current during start-up of the generator. The soft starter consists of a setup of thyristors connected in parallel in opposite directions from each other, as shown in Figure 37. The soft starter is connected between the generator and the grid. During connection of the generator to the grid, the maximum in-rush current should not exceed the generators nominal current. Without a soft starter, this current may be up to 6-8 times higher than the rated current. (Mohan, 2003)

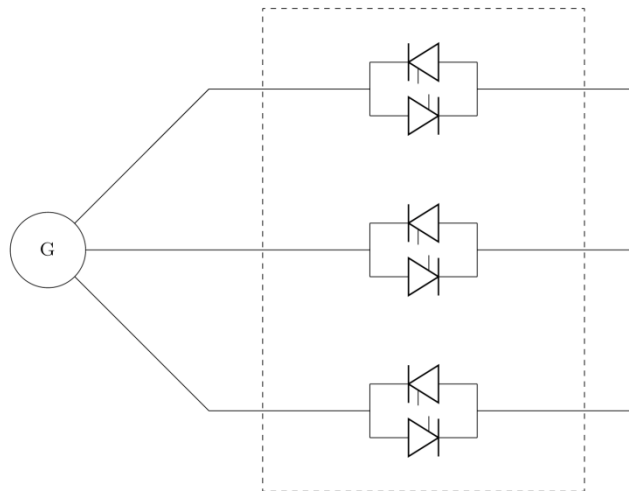

FIGURE 37: THE SYMBOL OF A 3-PHASE SOFT STARTER.

The soft starter is limiting an alternating current. During the positive half cycle, the lower thyristor conducts and during the negative half cycle the upper thyristor conducts. During steady state the soft starter conducts the entire period, since the current is exactly the size matching the grid properties.

When a large in-rush current appears, the soft starter limits it by conducting less than a whole period. The smooth connection of the generator to the grid, during a predefined number of grid periods, is achieved by adjusting the firing angle ( $\alpha$ ) of the thyristors. The relationship between the firing angle ( $\alpha$ ) and the resulting amplification of the soft-starter is highly nonlinear and is additionally a function of the power factor of the connected element. (Ackermann, 2005) (Mohan, 2003)

---

### CAPACITOR BANK

---

Induction generators demand reactive power in order to operate. If the system does not consist of a component providing the generator with reactive power, it consumes reactive power from the grid, which is not preferable. That is why a capacitor bank is used. Depending on amount of reactive power needed, the capacitor can connect or disconnect to the system. The capacitor bank is used in wind turbines with fixed speed or limited variable speed as induction generators are used in those systems. (Ackermann, 2005)

---

### FREQUENCY CONVERTER

---

If there is a mismatch in frequency between the generator and the grid, a frequency converter is installed. Frequency converters consist of rectifier and inverter. Inside the converter the connected circuits are a composite of diodes and parallel-connected switches. The switches may be diodes, thyristors, GTOs or IGBTs. The first circuit rectifies the incoming alternating current to direct current. In the second circuit, the DC-current is converted back to AC with the correct frequency matching the grid. (Ackermann, 2005)

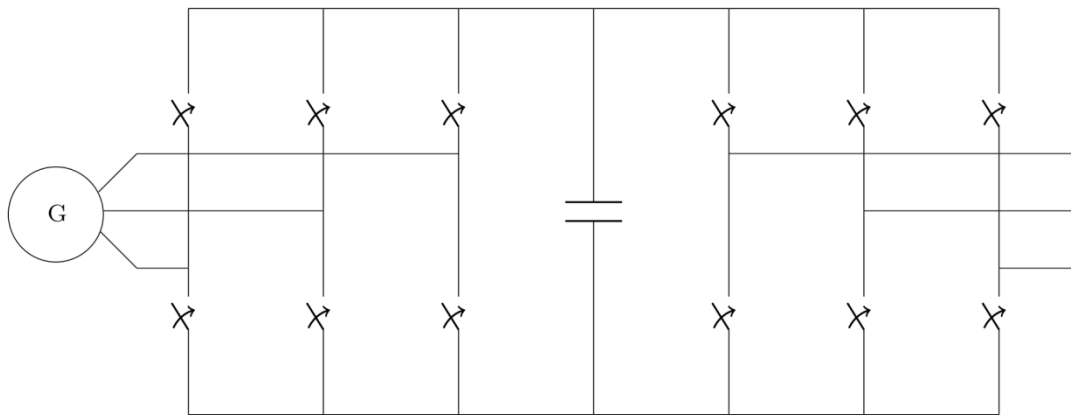

FIGURE 38: FREQUENCY CONVERTER.

Depending on type of the wind power plant, different kinds of frequency converters are used. Generator and rectifier must be chosen in combination, while inverters can be chosen independently of the generator. Diodes are used specifically to rectify while thyristors and transistors could be used to both rectify and invert. (Ackermann, 2005)

GTOs and transistors control both active and reactive power, which make them usable to any generator. Regular thyristors and diodes control only active power, which is why diode rectifiers or thyristor rectifiers can be used together only with a synchronous generator, as it does not require any magnetising current.

Simple thyristors and diodes are preferable since they are cheap, easy to use and have low losses. Disadvantages with diodes are; only conducting one way and no possibility to choose time of conducting. Because of this, they can only be used with a generator capable of controlling the voltage level, and with an inverter controlling the current. (Ackermann, 2005)

Since the wind speed varies, it is desirable to store energy at high wind speeds in order to compensate when the intensity is less. Converters may store energy for a while, to level out the voltage variations and to supply the grid with a stable frequency. (Ackermann, 2005)

---

## GEARBOX

---

The gearbox consists of two cogwheels, one large and one small. There is a shaft from the turbine to the large cogwheel, called the low-speed shaft. The larger cogwheel runs the smaller one. The generator is connected to a smaller cogwheel by the high-speed shaft. The task of the cogwheels is to transform the low speed from the turbine to a higher speed suitable for the generator. (Ackermann, 2005)

The generator demands a rotor speed of about 1500 rpm, varying dependently by the number of poles of the generator and the frequency. For this reason, the gearbox is a necessity to increase the velocity. The speed is slow and the torque is high at the turbine. Considering the generator, it is the opposite; the feeding axis into the generator has high speed and low torque. (Ackermann, 2005)

Problems often occur with gearboxes if they are incorrectly dimensioned, considering varying wind. Gearboxes in wind power plants are large, heavy, complicated and expensive. The best solution is to avoid gearboxes in the construction of wind power plants, but this is only possible if a permanent magnet induction generator is used. (Ackermann, 2005)

When dimensioning a gearbox, two main things are important, internal and external dimensioning. External dimensioning means the load. The manufacturer dimensions the internal of the gearbox. In order to achieve a correct inner dimensioning, characteristic about the external load must be known. (Ackermann, 2005)

---

## ROTOR BRAKE

---

A braking system is necessary in order to:

1. Keep the rotor in position when it is a standstill
2. Locking the rotor for service and repair work
3. Brake the turbine when the wind is too strong and power limitation is not enough

Most commonly used is a disc brake. The disk brake is dimensioned to securely keep the turbine stationary. The dimensions are calculated on the basis of the force of the highest wind speed possible in the area. The larger rotor diameter, the larger disc brakes, which may conclude in enormous disks. Disk brakes could be installed differently, either at the low-speed shaft or at the high-speed shaft. The most common way to install a rotor brake is at the high-speed shaft. The disk diameter will be kept as small as possible, since high speed results in low torque. (Ackermann, 2005)

Disadvantages with a rotor brake on the high-speed shaft:

1. This is not the safest way to install a rotor brake. If the gearbox or the high-speed shaft breaks, the braking function fails.
2. During a standstill, the rotor must be held by the gears, which leads to an increased wear of the teeth of the cog wheels.

In some of the earlier systems, brakes were installed at the low-speed shaft, which is possible in small wind turbines. In larger wind turbines it is more problematic, since the brakes must be extremely large compared to if installed at the high-speed shaft. (Ackermann, 2005)

## GENERATORS IN WIND POWER PLANTS

A wind power plant can be equipped with any type of generator. It is possible to complement with power electronics weather the generator produces alternating current or direct current, in order to match the power grid. (Hau, 2006)

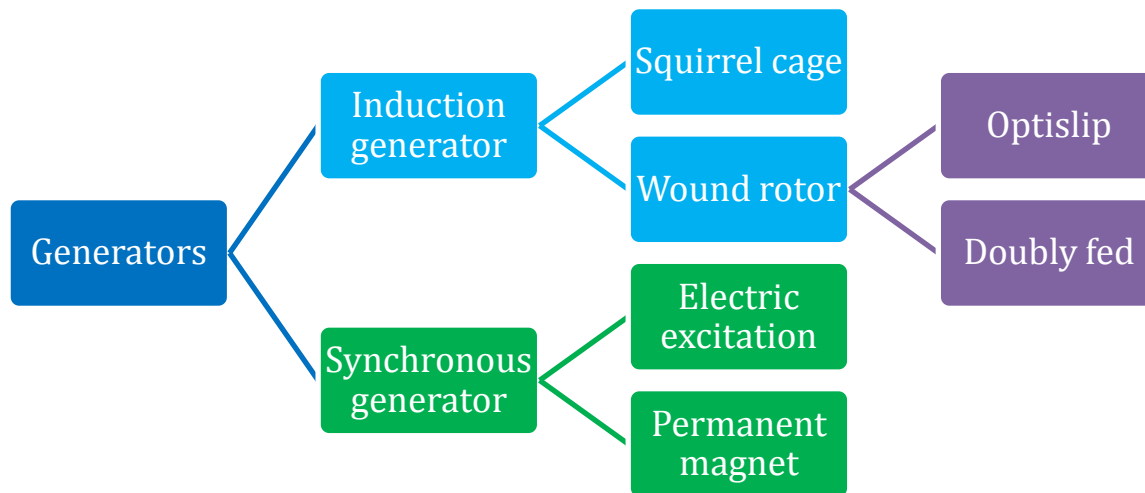

FIGURE 39: DIFFERENT KINDS OF GENERATORS.

DC generators have the advantage of being able to operate at varying rotor speeds, but today it is rare to use direct current generators for high voltage. Still, small wind turbines connected to DC generators are used for charging batteries, but these generators are not appropriate for larger wind turbines. For that reason, three phase AC generators are used in wind power plants, similar to generators in conventional power plants. Hence, the direct current machine will not be discussed in this chapter. (Hau, 2006)

The synchronous generator and the asynchronous generator are similar in their mechanical construction. There are two main components in the generator. The rotating part is called the rotor and the stator is the stationary part, as the names indicate. The rotor contains permanent magnets or windings, which generates a magnetic field when a current is flowing through the rotor. When the wind turbine set the rotor in motion, a rotating magnetic field arises. When the magnetic field is moving through the unmoving windings in the stator, a voltage is induced in these windings. Usually, the generator is producing alternating current. Current and voltage is changing direction for every revolution of the rotor. The generator speed and number of poles in the generator decide the frequency of the produced alternating current. (Hau, 2006)





FIGURE 40: INSIDE A NACELLE. PITCH CONTROL HYDRUALIC DYLANDER IN THE MIDDLE, INDUCTION GENERATOR TO THE RIGHT.

---

## INDUCTION GENERATOR

---

The induction generator is the most commonly used generator in the wind power industry today. There are several advantages with the induction generator such as robustness, simple mechanical construction and it is cheap to manufacture. Despite these advantages, the induction generator possesses a major disadvantage. The stator must have a reactive excitation current. Since it is not equipped with permanent magnets or is separately magnetised, the induction generator must receive its exciting current from another source. The reactive power may be supplied by a power electronic system or by the power grid.(Ackermann, 2005)

In the AC excitation case, the created excitation field rotates with the synchronous speed, which is determined by the current frequency and the number of poles in the winding. If the rotation speed of the rotor is higher than the synchronous speed, an electric field is induced between the rotating stator field and the rotor by a relative motion, also called slip. The slip causes a current in the rotor windings. The interaction between the stator field and the magnetic field in the rotor creates torque that sets the rotor in motion. The rotor of the induction generator can be designed as either a squirrel cage rotor or a wound rotor.(Ackermann, 2005)

## SQUIRREL CAGE INDUCTION GENERATOR, SCIG

---

This generator is mechanically simple, efficient and demands low maintenance. The speed of the SCIG changes by only a few percent due to the generator slip caused by changes in the wind. Because of this small speed change, the generator is appropriate for wind turbines with constant rotor speed. (Ackermann, 2005)

Wind turbines with SCIG are usually equipped with a soft starter and supply for reactive power compensation, since reactive power is necessary in order for the SCIG to operate. Wind fluctuations are transferred directly to the power grid, since the SCIG has a steep torque speed characteristics. These transients are most critical during connection to the grid, since the in-rush current may be of size 7-8 times higher than the nominal current. This may cause large disturbances in the voltage level, especially if the power grid is weak. Because of this, the connection to the grid must take place gradually in order to limit the in-rush current. (Ackermann, 2005)

The SCIG is stable and robust during steady state operation. The slip varies when the load varies. The main problem is the low full load power factor. The generator requires magnetising current for the stator windings in order to operate which is taken from the power grid. If the power factor is too low, this can be compensated by a capacitor bank connected in parallel with the generator. (Ackermann, 2005)

At high wind speeds, a wind turbine with SCIG can only produce a large amount of active power if a large amount of reactive power is available for it. It is not possible to control the quantity of reactive power, since it varies with varying circumstances for the wind. If no electrical components are used for supply of reactive power, it must be taken directly from the power grid. This may lead to further transmission losses that contribute to an unstable power grid. Modern power electronics and capacitor bank can be used to reduce the consumption of reactive power from the grid. A major disadvantage of this is the occurrence of electrical transients during switching in. (Ackermann, 2005)

If a fault occurs and no reactive compensation is used for the SCIG, voltage instability may take place in the grid. For example, the rotor speed of the wind turbine may increase, due to imbalance between electrical and mechanical torque. The SCIG draws a large amount of reactive power from the grid when the fault is corrected, which causes voltage decrease. (Ackermann, 2005)

SCIG can be used both for wind turbines with fixed rotor speed and wind turbines with variable rotor speed. (Ackermann, 2005)

## WOUND ROTOR INDUCTION GENERATOR, WRIG

---

In the WRIG, the windings can be connected externally by brushes or slip rings. The use of brushes or slip rings could also be avoided by using power electronics. When power electronics are used, power can be brought to the rotor circuit and the generator can be magnetised from either the rotor circuit or the stator circuit. It is then possible to use slip energy and feed into the output of the stator. The disadvantages with the WRIG are the price and it is not as robust as the SCIG. (Ackermann, 2005)

## OPTISLIP INDUCTION GENERATOR, OSIG

---

The characteristics of the OSIG include a variable slip. The slip can be chosen optimally, which results in less fluctuation in the output power. Compared to more complicated wind turbines systems with variable rotor speed, the variable slip is a simple, cost effective and reliable way to achieve load reduction. The OSIG is a WRIG with a variable rotor resistance connected to the rotor windings. The slip can be varied by changing the total rotor resistance with a converter connected to the rotor shaft. In this way, no slip rings or brushes are needed. The stator of the generator is directly connected to the grid. (Ackermann, 2005)

Advantages of this type of generator are a simple system, no required slip rings and improved operating speed range compared to the SCIG. The concept can reduce mechanical load and power fluctuations due to fast changes in the wind. Still, reactive power must be compensated. The disadvantages with the OSIG are:

1. Typically, the speed range is limited to 0-10% and it depends on the size of the variable rotor resistance.
2. The control of the active and reactive power is poor.
3. The slip power dissipates in the variable rotor resistance as losses.

(Ackermann, 2005)

## DOUBLY FED INDUCTION GENERATOR, DFIG

---

A doubly fed induction generator consists of a WRIG with stator winding directly connected to the power grid and the rotor windings connected to a bidirectional back-to-back IGBT voltage source converter. (Ackermann, 2005)

The reason why it is called doubly fed is because the stator voltage is taken from the grid and the rotor voltage is induced by the power converter. This system introduces the possibility of a variable speed function over broad range. The difference between the mechanical and electrical frequency is compensated by the converter. Whether the generator is operating under steady state or during a fault, it is controlled by the converter. (Ackermann, 2005)

The power converter consists of converters, one rotor side converter and one grid side converter. Both converters are controlled independently of each other. The main idea is that the rotor side converter controls the active and reactive power, by controlling the rotor current components. The DC-link voltage is controlled by the line-side converter. The line-side converter also ensures a converter operation at unity power factor. (Ackermann, 2005)

The DFIG has several advantages. It provides the possibility to control the reactive power. By independently controlling the rotor magnetising current, active and reactive power can be decoupled. It is not necessary for the DFIG to be magnetised from the power grid, since it also can be magnetised from the rotor circuit. The generator is also capable to produce reactive power that can be fed into the stator by the grid-side converter. This is not the most common case however. Usually the grid-side converter is not involved in the reactive power exchange between the turbine and the grid. (Ackermann, 2005)

In the case of a weak grid, where the voltage level may vary, the DFIG can produce or absorb an appropriate amount of reactive power, in the purpose of voltage control. (Ackermann, 2005)

The size of the generator is not related to the total amount of power from the generator. The total amount of power is associated with selected speed range and hence to the slip power. With increasing speed range, the costs of the converters will also increase. The speed range selection is based on an economical optimization of investments costs and increased cost efficiency. One disadvantage of the DFIG is the requirement of slip rings.(Ackermann, 2005)

---

## SYNCHRONOUS GENERATOR

---

The synchronous generator is more expensive and complicated than the induction generator. Despite this, it possesses a large advantage compared to the induction generator; it requires no reactive excitation current. (Ackermann, 2005)

The magnetic field in the synchronous generator can be created by permanent magnets or by regular field windings. With an appropriate number of poles (a multipole WRSG or multipole PMSG) the generator can be used without gearbox. (Ackermann, 2005)

Since the synchronous generator is connected to the power grid through a power electronic converter, it is best suited for full power control.(Ackermann, 2005)

The converter has two main tasks:

1. Operate as an energy buffer for variations in power, which may arise by wind gusts and also for transients occurring on the grid side.
2. Be in control of the excitation in order to stay synchronous with the frequency of the power grid.

Two types are appropriate for use in wind turbines with variable rotor speed, wound rotor synchronous generator and permanent magnet synchronous generator. (Ackermann, 2005)

---

## WOUND ROTOR SYNCHRONOUS GENERATOR, WRSG

---

The WRSG is widely used in the electric power industry. The stator windings are directly connected to the grid, which results in a rotation well suited to the grid frequency. The rotor windings gets magnetised through slip rings and brushes with direct current or by a brushless exciter with a rotating rectifier. Unlike the induction generator, the synchronous generator does not need any extra system for reactive power compensation. A DC flows through the rotor windings, which creates the magnetic field. The magnetic field rotates with synchronous speed. The synchronous speed is determined by the number of poles in the rotor and the frequency of the rotating field. (Ackermann, 2005)

## PERMANENT MAGNET SYNCHRONOUS GENERATOR, PMSG

---

Permanent magnet synchronous generators are an appropriate generator choice for a wind turbine. Since they can self magnetise, they can operate at high efficiency and power factor. The efficiency is higher in a permanent magnet machine compared to an induction machine, since excitation takes place without any supply of energy. Still, the materials used in the PM machines are more expensive and more difficult to handle during the manufacturing process. When PM machines are used, a full-scale power converter also must be used in order to adapt voltage and frequency to the power grid, which is an added cost. (Ackermann, 2005)

One large advantage is produced power at any speed. The stator of the PMSG is wound, and the rotor is provided with a permanent magnet pole system and may have salient poles or may be cylindrical. Salient poles are more common in the use of slow-speed machines, which is the most appropriate variant for a wind power plant. (Ackermann, 2005)

## SUMMARY OF ELECTRIC SYSTEMS

The electrical system is designed to fit a wind power plant with fixed rotor speed or variable rotor speed. Below is a summary of the most common systems.

### FIXED SPEED

Figure 41 shows a construction of a wind power plant with fixed speed and a SCIG. Different power limitations can be used. Stall control and active stall control are more commonly used than pitch control. A soft starter and a capacitor bank are used to decrease disturbances on the grid. The generator demands reactive power, which is supplied by the capacitor bank. The soft starter prevents the in-rush current from increasing largely, which usually occurs before the rotor speed of the generator has reached a sufficient level. (Ackermann, 2005)

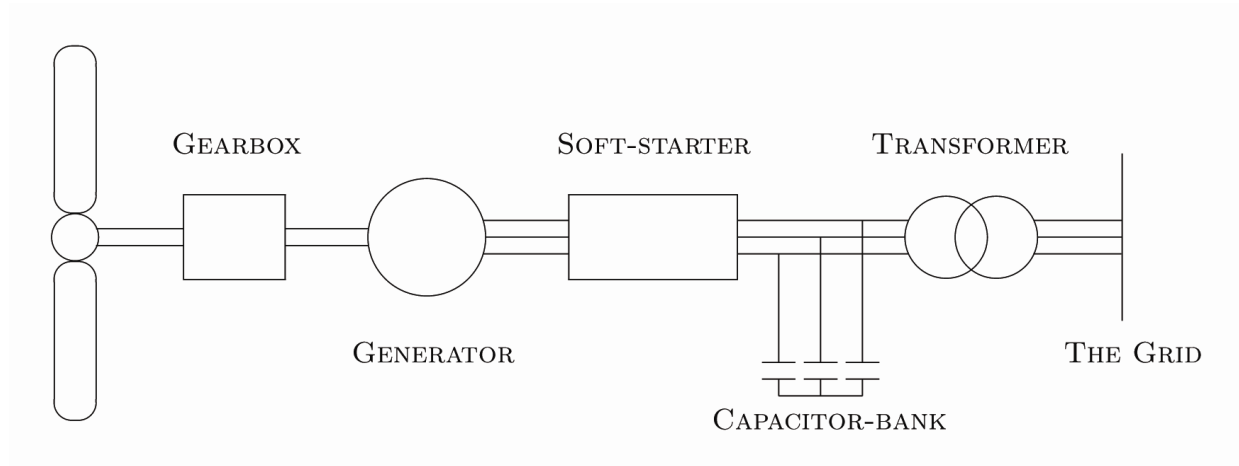

FIGURE 41: FIXED SPEED.

---

## LIMITED VARIABLE SPEED

---

Figure 42 represents a wind turbine with limited variable speed and variable rotor resistance. The induction generator is connected directly to the grid. Because of the variable rotor resistance, the speed can vary to a certain point. A capacitor bank manages the reactive power compensation and the connection to the grid is smooth, since a soft starter is used. The rotor resistance controls the slip of the generator, which makes it possible controlling the power output. (Ackermann, 2005)

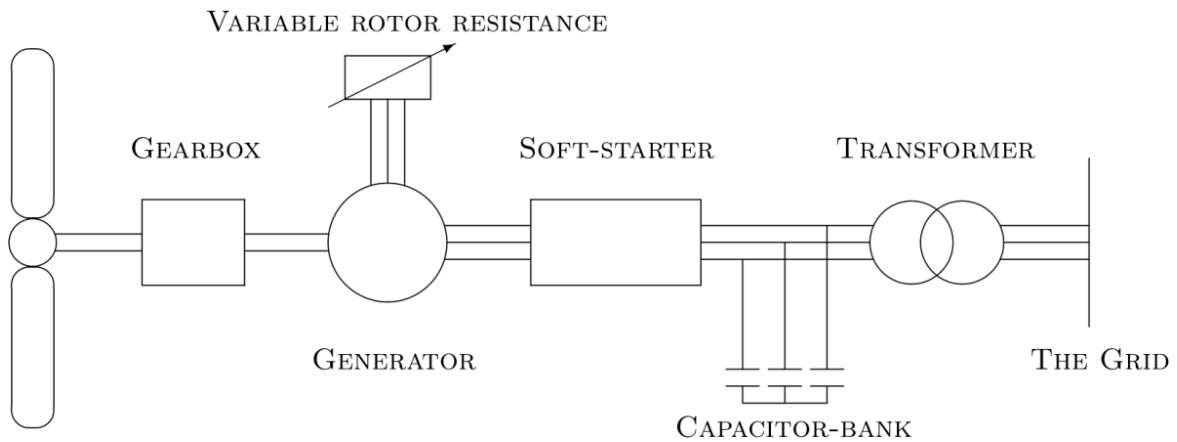

FIGURE 42: LIMITED VARIABLE SPEED.

---

## VARIABLE SPEED WITH PARTIAL SCALE FREQUENCY CONVERTER

---

The configuration in Figure 43 is known as the DFIG concept. It has variable rotor speed, which increases the efficiency and allows the turbine to operate during optimal circumstances. Since variable speed is used, a frequency converter is needed. A result of this is a no longer need for a soft starter or capacitor bank in the system. (Ackermann, 2005)

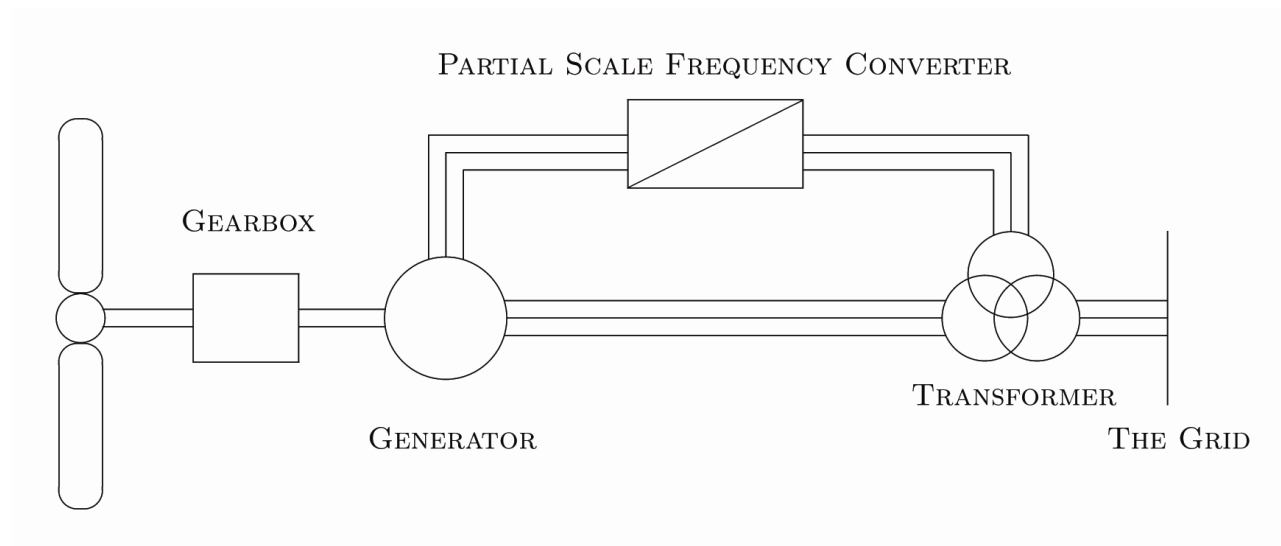

FIGURE 43: VARIABLE SPEED WITH PARTIAL SCALE FREQUENCY CONVERTER.



---

## VARIABLE SPEED WITH FULL-SCALE FREQUENCY CONVERTER

---

In the wind turbine system in Figure 44, induction- synchronous- or a permanent magnet generator can be used. The system has variable rotor speed and a full-scale frequency converter taking care of reactive power, resulting in a smooth grid connection. Because of this, neither capacitor bank nor soft starter is required. A gearbox is not necessary if a permanent magnet synchronous generator is used. (Ackermann, 2005)

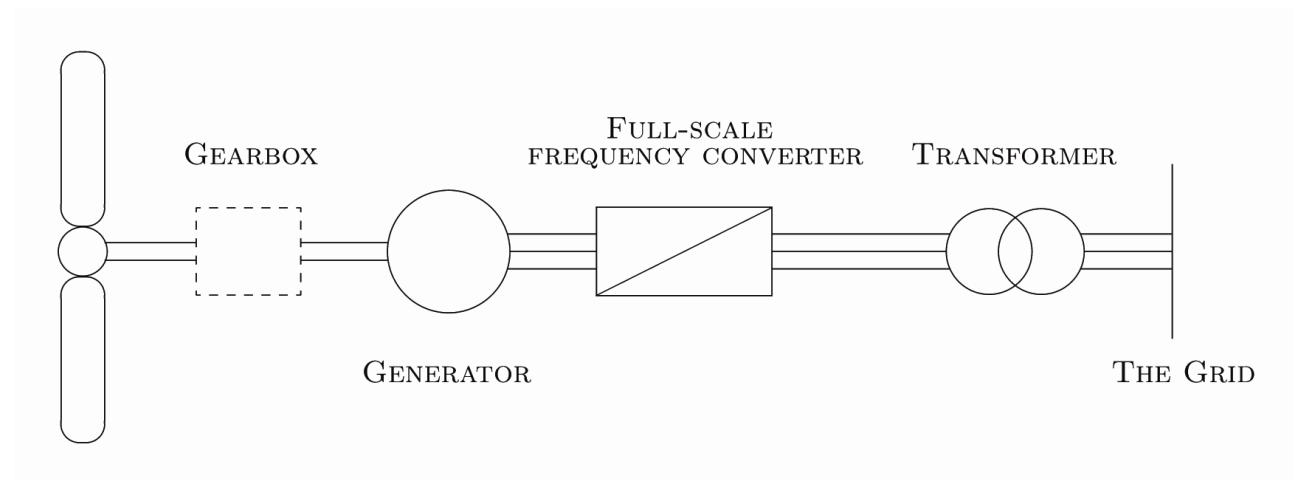

FIGURE 44: VARIABLE SPEED WITH FULL-SCALE FREQUENCY CONVERTER.



## CONNECTION OF A WIND POWER PLANT TO THE POWER GRID

---

Connection of a wind power plant to the power grid must be done accurately to prevent changes in frequency and voltage level. In order to maintain stability after the connection, the power plant must be supervised at operation. Faults may then be detected before the power quality is affected negatively. A consumer experiences poor power quality as flashing light bulbs or other disturbances in sensitive home electronics. Apparatus are designed to operate at a specified voltage level and it is important to keep the voltage as close to this pre-defined value as possible in order to prevent damage of the equipment. A voltage collapse may be the result of large disturbances in the power grid, which could cause black out in exposed areas. The modern society is extremely dependent of a well functional power system and lack of electricity is not tolerated. Different kinds of fault may occur in the power system and it is important to know how to prevent and correct them.

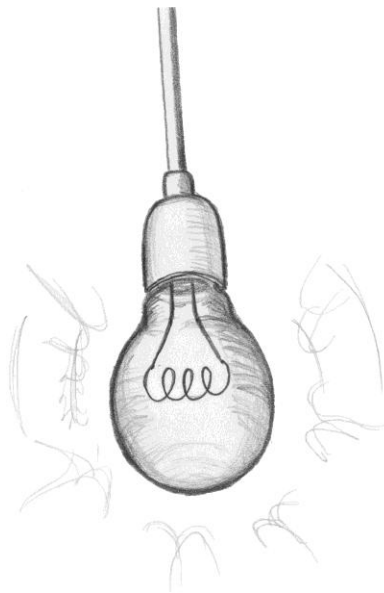

## FACTORS AFFECTING FREQUENCY AND VOLTAGE IN A POWER SYSTEM

---

There are several factors affecting the balance in the power system during start up, operation and shutdown of the wind power plant. When the power flow is changed, frequency and voltage will be changed as well. This affects the power system negatively since unbalance occurs.

### START UP

---

When a wind power plant is starting up, the power production changes. This leads to a voltage change at the connection between the power plant and the grid. Due to this change, voltage flicker is created, which affects the power quality negatively. In the case of an induction generator, reactive magnetising current is required in order for the generator to operate. Before the capacitor bank starts to operate, the reactive power is consumed from the grid, which causes a voltage drop. The capacitor bank starts to

operate after a few seconds and the voltage level is again restored. Another factor causing a voltage change is generation active power. This also leads to an increased voltage. (Ackermann, 2005)

A wind power plant with variable rotor speed starts the power production smoother than a power plant with fixed speed. The output power is regulated with pitch control, in the variable speed case, which is smoother than stall control that is used in fixed speed wind turbines. (Ackermann, 2005)

---

### DURING OPERATION

---

When the system is operating at steady state, the power production and power consumption is equal, which results in constant frequency and voltage. This is an optimal situation being rather rare. The consumption and the production are seldom exactly the same, and when a deviation occurs, frequency and voltage are affected. When the load is changed, i.e. when consumed power is changed, the electric torque on the generator will not remain the same. This will cause a mismatch between the electric torque and the mechanical torque and the generator speed has to adapt to this. (Kundur, 1994)

---

### TWO CASES OF IMBALANCE

---

There are two possible scenarios when a mismatch between the consumed and produced power occur. If consumed power increases while produced power is constant, the generator will no longer operate in steady state. During this course of events, the electric torque at the generator will start to increase, while the rotor speed decreases. Figure 45 shows the relation between mechanical torque and electrical torque.

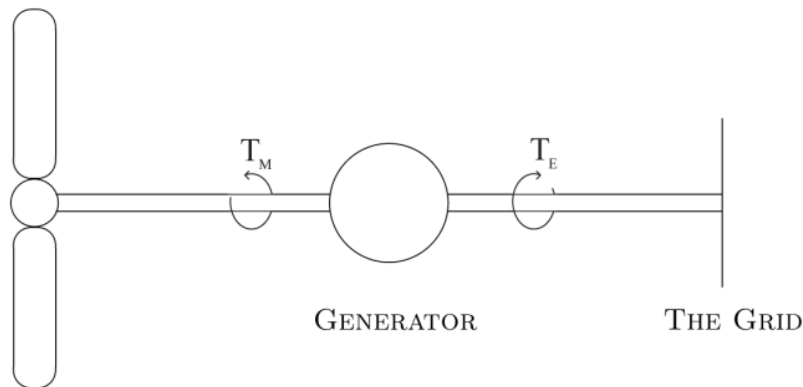

FIGURE 45: RELATION BETWEEN MECHANICAL AND ELECTRICAL TORQUE.

$T_{\text{electrical}}$  equals  $T_{\text{mechanical}}$  when the generator is operating in steady state.  $T_{\text{electrical}}$  increases when consumed power increases, and this will result in a negative value of  $T_{\text{accelerating}}$ , and the rotor speed will start to decrease since  $T_{\text{accelerating}}$  is proportional to the rotor speed deviation. A decreasing rotor speed will lead to a decreased frequency on the grid. Since the frequency level should be held close to constant at the power grid, frequency deviation is not wanted. To restore the level, there are control systems. In the other case, a surplus in produced power, compared to the amount of consumed power, will cause a

decrease of the electric torque and the rotor speed will hence increase. This results in an increase of the grid frequency. Power regulation or shutting turbines can handle this type of instability. This will lead to a smaller amount of produced power and a decrease in frequency.(Kundur, 1994)

---

## SHUTTING DOWN

---

If the wind speed is too low (3-4 m/s), the power plant will be shut down because of the negative power flow. On the other hand, if the wind speed is too high (>25m/s), the plant will be shut down due to high mechanical strain on the turbine. During shut down, the impacts on the grid is larger, since the turbine produces rated power at high wind speeds. When the turbine suddenly is shut down and the power decreases from rated power to zero in a moment, the voltage at the connection point will decrease. (Ackermann, 2005)

When a *fixed speed turbine* is shut down, the active power is reversed in order to make sure that the turbine stops. This happens in an instant. Shut down of *variable speed turbine* is smoother, compared to a shutting down a fixed speed wind turbine. The produced power decreases in matter of seconds to make sure the turbine stops. (Ackermann, 2005)

---

## POWER QUALITY

---

The aim in a power system is to keep the power quality as good as possible in order to maintain a strong system durable to disturbances and stress. Perfect power quality is defined by a system with sinusoidal continuous voltage with constant amplitude and frequency. It relies on the interaction between power production and power consumption. If the production level is equal to the demand level, high power quality is achieved. Another influence on the power quality is the *voltage stability*. Voltage stability refers to how well a power system can maintain a steady voltage at all buses, after a disturbance has occurred. (Larsson, 2000)

When buses are exposed to a radical change of voltage, *voltage instability* occurs. This could lead to tripped transmission lines if the voltage is exposed to a large increase. If the voltage level is progressively lowered, load losses may occur. When the voltage is stable, the variations in voltage are small or non-existent. Voltage variations can be subdivided into slow voltage variations, voltage dips, flicker, transients and harmonic voltage distortions. (Larsson, 2000) (Martins, 2006)

*Slow voltage variations* are defined as changes in the RMS value of the voltage during a time span of a couple of minutes or more. Variations in the power grid depend on variations of loads or generation units. Wind power plants have a tendency to vary the power production. These variations depend on wind conditions or other circumstances, such as switching the power plant on or off during high wind speeds, which causes changes in the power output. (Larsson, 2000)

*Voltage dips* arise when there is a reduction of voltage supply during a period of a cycle up to a couple of seconds. They occur due to e.g. short circuits and fast re-closings of circuit breakers. If a wind power plant is optimally equipped with soft starters, the wind turbine will not cause voltage dips. (Larsson, 2000)

*Flicker* is a more common word for short-term dynamic voltage variations in the power quality. In wind power plants, flicker arises in two modes. When the turbine is operating at steady state, flicker is caused by fluctuations in power due to wind conditions variations or mechanical characteristics. The tower shadow effect is also a possible source for flicker. During switching operations, such as start, stop or switching between generators, flicker may also arise. (Larsson, 2000) (Petru, 2003)

*Voltage harmonics* are always apparent in the grid. These are components with a certain frequency. The frequencies are multiples of the supply frequency, i.e. 100 Hz, 150 Hz, 200 Hz etc. in the Swedish power grid. Power electronic loads, non-linear loads, rectifiers and inverters in motor systems are all possible sources of voltage harmonics. When equipment is exposed to large voltage harmonics, outcomes may be equipment overheating, tripping of sensitive loads and interference with communication circuits. During connection of a capacitor bank to the grid, an oscillating circuit is created with the grid inductance. Since harmonics are always present in the system, a single harmonic will be amplified by the oscillating circuit. The harmonic distortion can be quantified by different methods. The most common method is total harmonic distortion, THD. (Larsson, 2000)

*Transients* arise primarily when wind turbines with fixed speed are started or stopped. During a connection of the wind power plant to the grid, the first step is to start the generator. The next step is to connect the generator to the grid. A soft starter is used in order to avoid a large in-rush current. When the generator and soft starter is connected, the capacitor bank is switched. During this happening, a large current peak occurs, since the capacitor bank is connected without any soft switching devices. It is not unusual that the transient voltage reaches values of the double of the rated current of the wind turbine. The voltage in the low-voltage area will be influenced by this transient, and may affect sensitive equipment. (Larsson, 2000)

Power quality also involves *frequency stability*. Normally, the frequency level in larger power systems is very stable. When an increased amount of wind power plants are connected to the grid, the fluctuating outputs may cause instability in frequency. For the occurrence of instability due to wind power, a large amount of wind turbines is demanded, and Swedish power production is far from that level today. (Larsson, 2000)

## UNBALANCE IN THE POWER SYSTEM

---

When the balance in a power system is disturbed, it is important to quickly correct the fault or disconnect the exposed line fast in order to avoid a possible voltage collapse. In order to maintain good power quality and a balanced system power production, voltage and frequency must be as close to constant as possible, which can be achieved in several ways. (Ackermann, 2005)

### ACTIVE POWER CONTROL

---

If there are changes in power supply or consumption, a temporary imbalance may occur. This could affect the operation of the wind power plant and/or disturb the consumers. To avoid unbalanced conditions, the amount of power demanded can be predicted. Thereby it is possible to control the power output of the plant. By controlling the active power flow and making sure of a stable frequency, overloading of the transmission lines can be avoided. This can be done without affecting the power quality. (Ackermann, 2005)

### FREQUENCY CONTROL

---

Usually, the frequency in a power system does not differ more than  $\pm 0.1$  Hz. In Europe the frequency is 50 Hz and it is very seldom out of the range of 49-50.3 Hz. The value of frequency indicates the balance between produced and consumed power. When unbalance occurs, it is out of desired range. A power system has several control systems in order to return the frequency back to its nominal value. Depending on the magnitude of the frequency change, different control systems can be used. (Ackermann, 2005)

If the consumption is larger than the production, the rotational speed of the generators decreases. Consequently, this will lead to a decreased frequency in the system. There are units in a power system, which consists of frequency-sensitive equipment. Such units are called *primary control units*. The primary control units also called fast reserve, increases their generation until the system remains balanced and the frequency is again stabilized. The control is performed within a time span of 1-30 seconds. (Ackermann, 2005)

The *secondary control*, called long-term reserve, is installed within a time span of 10-15 minutes, in order to restore the frequency to its nominal value and release used primary reserves. This means that the secondary control will lead to a slower increase or decrease of generation. The secondary control usually consists of hydro storage plants, rapidly starting gas- turbine power plants and load shedding. The secondary control is an important part of the power system. The size of the reserve corresponds to the largest amount of power possible to disconnect. (Ackermann, 2005)

In case of high frequency in the system, power regulation is used in order to restore the correct frequency value. In wind power plants, regulation such as pitching, could be used. Another possibility is to shut wind power plants down. It is more difficult to handle low frequency problems compared to high frequency problems. Because of this, power production at normal frequency is kept lower than capacity, in order to have the possibility to provide secondary control when the frequency is too low. (Ackermann, 2005)

## VOLTAGE CONTROL

---

It is desirable to keep the voltage at the connection point between grid and power plant as close to the nominal voltage of the grid as possible. The equipment used by customers is designed to operate at a certain voltage level. If this voltage exceeds, the equipment could be damaged. The voltage can be controlled by controlling the amount of produced reactive power. Reactive power compensation is defined in terms of power factor range. The power factor should be close to 1, in the point where the power plant is connected to the grid. A power factor equal to 1 result in an active power as large as possible and a reactive power as small as possible. (Ackermann, 2005)

## CONNECTION OF LARGE PRODUCTION UNITS TO THE POWER GRID

---

In order to maintain good power quality, all production units connected to different voltage levels in the grid must reach certain requirements and standards to not affect the quality with disturbances. Some properties must be taken into consideration during connection of production units to the power grid. Size of the production unit is an important matter. The size determines at which voltage level in the power grid the connection is done. Small individual wind power plants are often connected to the distribution grid, which is not very common any more. Today, wind power plants could be 2 MW or larger and are often linked together with other plants in a farm before the grid connection is performed. The connection in this case is done at higher voltage levels than the distribution grid. Svenska Kraftnät has requirements being fulfilled during connection of a production unit, in order to keep a good power quality.



FIGURE 46: WIND POWER PLANTS PLACED IN A ROW.

When planning a large wind farm, the placement of the wind power plants is of importance, as the variations in production depend on it. If the shape of the wind farm is a long row, as in Figure 46, changes in wind conditions hit all the wind power plants at the same time. This results in an immediate change in output power from the farm. If the wind power plants instead are placed as a matrix, as in Figure 47, the changes in wind does not affect all the plants at the same time. By this, it is easier to regulate in order to keep a good quality on the power.



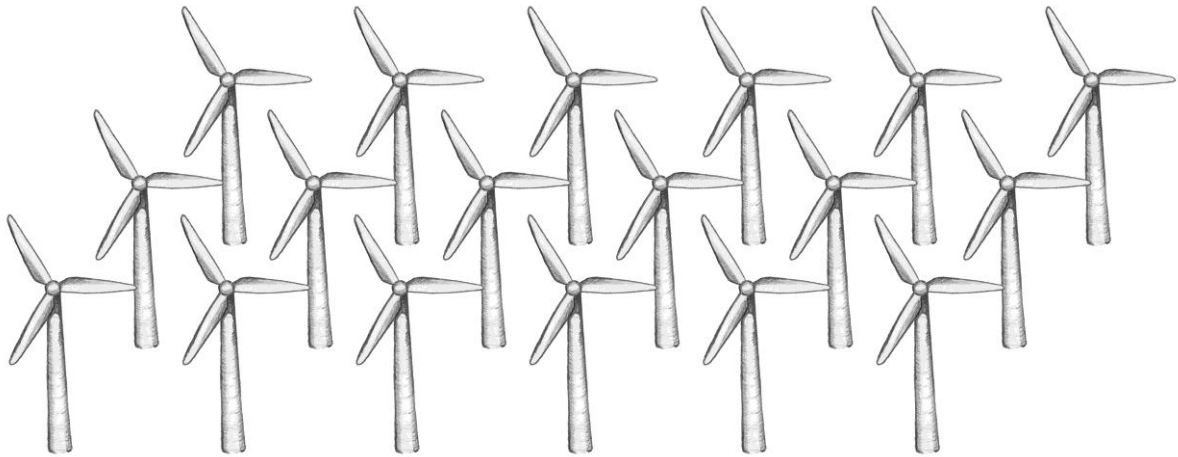

FIGURE 47: WIND FARM WITH PLANTS PLACED IN A MATRIX.

It is also important that the plants do not to start and stop at the exact same time, since these events create some kind of disturbances. A plant is pre-set to stop at a certain wind speed in order not to outwear the construction prematurely. One solution is to set the plants to start and stop at different wind speeds. Usually wind power plants are started at about 3 m/s and stopped at 20-25 m/s. When carrying out service, the plants should also be set not to start operating again at the same time, especially since service can be done at any wind speed. A production unit of many wind power plants may create large disturbances if unlucky, but with good planning, it should not be a problem to reach the demands and standards of Svenska Kraftnät, to keep a good power quality.



## ENVIRONMENTAL IMPACT

---

Wind power energy is a renewable and environmental friendly energy source. No pollutions of carbon dioxide, CO<sub>2</sub>, or other greenhouse gases are discharged. The environment is affected by different factors in one way or another by wind power plants and many studies have been done to investigate the environmental influence. With knowledge about the environment and how it is affected, it is possible to limit the bad environmental impacts. There are three important phases of where environmental impacts are involved, construction-, operation- and termination phase. (Vindkraft och miljö, 2008)



### CONSTRUCTION

---

When installation and building of a wind power plant is about to begin, the surroundings are undergoing a change for plants and animals. Many of the effects that occur are indirect affections. Wind power plants located at land or sea affects its surroundings differently and both types will be discussed. (Vindkraft och miljö, 2008)

The transportation of a wind power plant, before it is placed at its location, is included in the environmental impact, because of the CO<sub>2</sub> discharge from the trucks. When the foundation is drilled into the ground the sound level is raised above normal range, which is seen as an environmental impact. Both of these impacts are non-lasting and will disappear when the wind power plant is in operation. (Vindkraft och miljö, 2008)

When power plants are constructed off shore, the transport and the establishment of foundations are included into the environmental impacts. Especially with the usage of the foundation monopole, the sound level is extra high, since a pipe drilled into the ground constitutes this foundation. The sound levels, when establishing wind power plants, could disturb the surroundings at sea. The ground is affected when establishing the foundations to ground and digging down cables. Spill from sediment, is

another impact that could cause muddy water and get spread over fish, plants and sea bed. This might result in some plants not getting enough light and have problems surviving. The kind of sea bed and streams in the water will affect the result as well. (Vindkraft och miljö, 2008)

## IN OPERATION

---

When a wind power plant is in operation state, both animals and plants and even humans are concerned. Many studies about these impacts have been done, and how they possibly could be eliminated. There is no *pollution* of CO<sub>2</sub> or other greenhouse gases from a wind power plant in operation. (Vindkraft och miljö, 2008)

There are many opinions about the *landscape* scenery, whether a wind power plant changes it or not. In Figure 48, an example is shown of the appearance of several wind power plants at the coast on Gotland. In order to get an idea of how it will look in advance, a computer software can be used to visualize the picture, before a decision is made about constructing new wind power plants or not. At sea, problems with the scenery are less, compared to land, as long as they are not placed too close to the coastline. (Vindkraft och miljö, 2008)



FIGURE 48: LANDSCAPE SCENERY OF NÄSUDDEN, SWEDEN.

Many studies have been carried out in order to investigate how *birds* are affected by wind power plants. These studies have shown that bird's affection is not worth mentioning. Birds notice the plants early enough to avoid them. (Fåglar och vindkraftverk, 2008)

Studies about *bats* have been done in order to see how they are affected by wind power. Many insects, which are food for the bats, gather around the machinery. This result is bats flying into the rotor blades. (Fladdermöss, 2008)

Problems with *creation of ice* on the power plants are not common. When problems of this type appear, it is mostly in cold mountain areas where ice can be found on the rotor blades.

Studies of wind power plants offshore, do not show negative affections of *fish* when wind power plants in the neighbourhood are in operation. In fact, a positive effect is noticed. The tower may function as a artificial reef with mussels and alga growing on it. This is good for the surrounding animal life, since fish are often found around reef as well. (Fiskar, 2008)

Noise arises from the machine house and rotor blades in motion. There are rules about the *sound* level from wind power plants. In Sweden, every wind power plant undergoes an individual test at the Court of environmental issues. When placing a wind power plant close to a residential area; sound from the plant may not exceed 40 dB. When placing it close to a cottage this limit is 35 dB.



At offshore wind power plants, *sounds and vibrations* during operation are investigated. The sounds are low frequent and propagates in water, but does not affect the animal life noticeable, as a study from “Bottniska viken” shows. (Båmstedt, 2009)

There have also been studies of how the human is affected by *noise*. They indicate that noise is experienced more annoying in the countryside than in densely populated areas. This could depend on that cities already have a higher sound level than the countryside, and therefore people do not react when another sound is added. It has also shown that people able to see the windmills experienced the noise from them to be more disturbing than those who could not see them. (Vindkraftens miljöpåverkan, 2008)

Simple studies of *cables* in the sea have not shown any injuries of the animals, but it seems take longer time for the animals to pass them. The animals appear to be affected by the magnetism surrounding the cables, in both cases of AC or DC. More studies are needed to investigate disturbances from cables.

## TERMINATION OF A WIND POWER PLANT

---

At termination there is about the same environmental impact as in construction, transports and sounds caused by the demolishment of it. Material possible to recycled is used, and the ground will be reconstructed after a termination. (Vindkraft och miljö, 2008)

Before establishing a wind power plant the location is carefully investigated with consideration to unusual animals or flora, as well as possible environmental impacts occurring because of the wind turbine. The time of the year is also important, i.e. it is not a good idea to put up a wind power plant during breeding season for birds or when the fish play.

## REFERENCES

---

- 20th Century Developments*. (2002). (T. W. Development, Producer) Retrieved 2009-29-06 from Illustrated History of Wind Power Development: <http://www.telosnet.com/wind/20th.html>
- Ackermann, T. (2005). *Wind power in power systems*.
- Association, D. W. (2003-06-06). *History of Wind Turbines*. Retrieved 2009-06-20 from Danish Wind Industry Association: <http://www.talentfactory.dk/en/pictures/index.htm>
- Boverket. (2009). *Vindkraftshandboken - Planering och prövning av vindkraftverk på land och i kustnära vattenområden*. Boverket.
- Båmstedt, L. S. (2009- 05-05). *Effekter av undervattensljud från havsbaserade vindkraftverk på fisk i Bottniska viken*. Retrieved 2009-27-07 from Naturvårdsverket: <http://www.naturvardsverket.se/sv/Verksamheter-med-miljopaverkan/Energi/Vindkraft/Vindval/Projekt-och-resultat/Ljud-i-marina-miljon---projekt-inom-Vindval/Effekter-av-undervattensljud-fran-havsbaserade-vindkraftverk-pa-fisk-i-Bottniska-viken/>
- Carlson, O. (2002). *Vind- Sol och Vågkraftverk*. Gothenburg: Chalmers tekniska högskola.
- Elteknik*. Gothenburg: Chalmers University of technology.
- EMC, elkvalitet och elmiljö*. (2007). Retrieved 2009-09-21 from Elforsk: [http://www.elforsk.se/distribut/elkvaldok/nummer%208/bilaga\\_%205b.pdf](http://www.elforsk.se/distribut/elkvaldok/nummer%208/bilaga_%205b.pdf)
- EMC, elkvalitet och elmiljö*. (2007). Retrieved 2009-21-09 from Elforsk: [http://www.elforsk.se/distribut/elkvaldok/nummer%208/bilaga\\_%205b.pdf](http://www.elforsk.se/distribut/elkvaldok/nummer%208/bilaga_%205b.pdf)
- Energimyndigheten. (2008). *Energiläget 2008*. Energimyndigheten.
- Fiskar*. (2008-15-01). Retrieved 2009-28-07 from Energimyndigheten: <http://www.energimyndigheten.se/sv/om-oss/var-verksamhet/framjande-av-vindkraft1/Forskning/Djurlivet--/Fiskar>
- Fladdermöss*. (2008-15-01). Retrieved 2009-28-07 from Energimyndigheten: <http://www.energimyndigheten.se/sv/om-oss/var-verksamhet/framjande-av-vindkraft1/Forskning/Djurlivet--/Fladdermoss/>
- Fåglar och vindkraftverk*. (2008-15-01). Retrieved 2009-28-07 from Energimyndigheten: <http://www.energimyndigheten.se/sv/om-oss/var-verksamhet/Framjande-av-vindkraft1/Vindkraftens-effekt-pa-omgivningen/Djurlivet--/Faglar-och-vindkraftverk>
- GothiaVind - Vindkraft*. (n.d.). Retrieved 2009-16-06 from Gothia Vind: <http://www.gothiavind.se/vindkraft.html>
- Hau, E. (2006). *Wind Turbines - Fundamentals, Technologies, Application, Economics*. Berlin Heidelberg: Springer-Verlag.

- Kundur. (1994). *Power System Stability and Control*. McGraw-Hill, Inc.
- Larsson, Å. (2000). *The Power Quality of Wind Turbines*. Gothenburg: Chalmers.
- Manwell, M. R. (2002). *Wind Energy Explained*. Sussex: John Wiley & Sons Ltd.
- Martins, M. (2006). *Voltage Stability Issues Related to Implementation of Large Wind Farms*. Gothenburg: Chalmers.
- Mohan, U. R. (2003). *Power Electronics*. Hoboken: John Wiles & SOns, Inc.
- Naturvårdsverket. (2007). *FN:s klimatpanel 2007: Den naturvetenskapliga grunden*. Stockholm: Naturvårdsverket.
- Petru, T. (2003). *Modeling of Wind Turbines for power System Studies*. Gothenburg: Chalmers.
- Rujun Shen, T. M. (2009-04-20). *China's wind power boom to outpace nucleus by 2020*. Retrieved 2009-12-07 from Reuters UK: <http://uk.reuters.com/article/idUKPEK33615120090420>
- Sidén, G. (2009). *Förnybar energi*. Studentlitteratur.
- Särdals kvarn*. (n.d.). Retrieved 2009-28-07 from Särdals kvarn: <http://www.sardalskvarn.se/>
- Tip speed ratio*. (2009). Retrieved 2009-09-14 from REUK: <http://www.reuk.co.uk/Wind-Turbine-Tip-Speed-Ratio.htm>
- Turbowinds. (1999). *Active Stall Control*. Retrieved 2009-10-29 from Turbowinds: <http://www.turbowinds.com/activestall.html>
- U.S Department of Energy. (u.d.). *20% Windpower by 2030*. Retrieved 2009-12-07 from <http://www.20percentwind.org/20p.aspx?page=Overview>
- Vattenfall. (2009). *Lillgrund vindkraftpark - Ett svenskt pilotprojekt inom havsbaserad vindkraft*. Värnamo, Sweden: Vattenfall Vindkraft.
- Vattenfall. (2008-10-07). *Näsudden - centrum för Vattenfalls vindkraftsutveckling*. Retrieved 2009-05-10 from Näsudden - centrum för Vattenfalls vindkraftsutveckling: [http://www.vattenfall.se/www/vf\\_se/vf\\_se/518304omxva/518334vxrxv/518814vxrxv/521124omxvi/631162karta/565286olida95265/index.jsp](http://www.vattenfall.se/www/vf_se/vf_se/518304omxva/518334vxrxv/518814vxrxv/521124omxvi/631162karta/565286olida95265/index.jsp)
- Vindkraft och miljö*. (2008-26-09). Retrieved 2009-28-07 from Vattenfall: [http://www.vattenfall.se/www/vf\\_se/vf\\_se/518304omxva/518334vxrxv/518814vxrxv/521124omxvi/567159vindk/index.jsp](http://www.vattenfall.se/www/vf_se/vf_se/518304omxva/518334vxrxv/518814vxrxv/521124omxvi/567159vindk/index.jsp)
- Vindkraft stör näten*. (2009-18-03). Retrieved 2009-27-07 from Ny Teknik: [http://www.nyteknik.se/nyheter/energi\\_miljo/vindkraft/article538889.ece](http://www.nyteknik.se/nyheter/energi_miljo/vindkraft/article538889.ece)
- Vindkraftens miljöpåverkan*. (2008). Retrieved 2009-28-07 from Naturvårdsverket: <http://www.naturvardsverket.se/Documents/publikationer/620-8310-6.pdf>
- Wizelius, T. (2002). *Vindkraft i teori och praktik*. Lund, Sweden: Studentlitteratur.



# Appendix C

## Elaborations



## C-1

*Laboration Vindkraft. Turbin med konstant varvtal*



# Laboration. Vindkraft.

## Turbin med konstant varvtal.

### Inledning

I ett vindkraftverk sker två energiomvandlingar. Först omvandlas vindens rörelseenergi till rotationsenergi. Därefter görs en omvandling av den mekaniska energin till elektrisk energi. Det är den elektriska energin som sedan levereras via elnätet ut till elkonsumenterna. Omvandlingen från rörelseenergi hos vinden till rotationsenergi görs genom ett aerodynamiskt/mechaniskt system, i vilket turbinrotorn utgör den viktigaste komponenten. Den påföljande omvandlingen från mekanisk energi till elektrisk energi görs i en generator.

Rent generellt kan vindturbiner indelas i två huvudkategorier: Turbiner med konstant varvtal alternativt turbiner med varierande varvtal. I turbiner med konstant varvtal roterar rotorbladen alltid med samma hastighet oberoende av vindhastigheten. Detta kan jämföras med turbiner med varierande varvtal, i vilka rotationen varierar beroende på vindens hastighet.

En turbin med fast varvtal består av följande huvudkomponenter: Turbin, växellåda och generator. Generatoren anslutes till el-nätet. Principen framgår av figur 1.

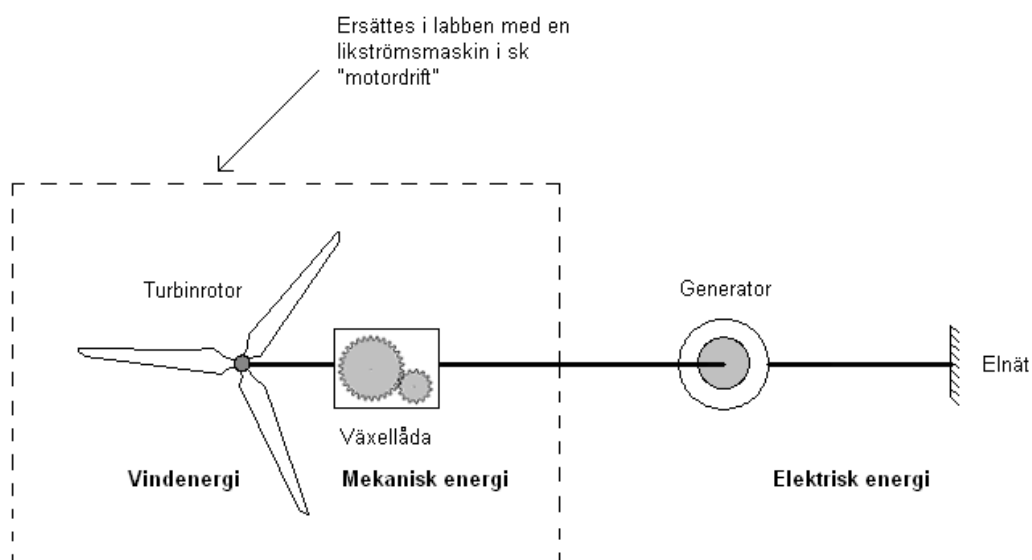

Figur 1. System för elkraftgenerering med hjälp av vind

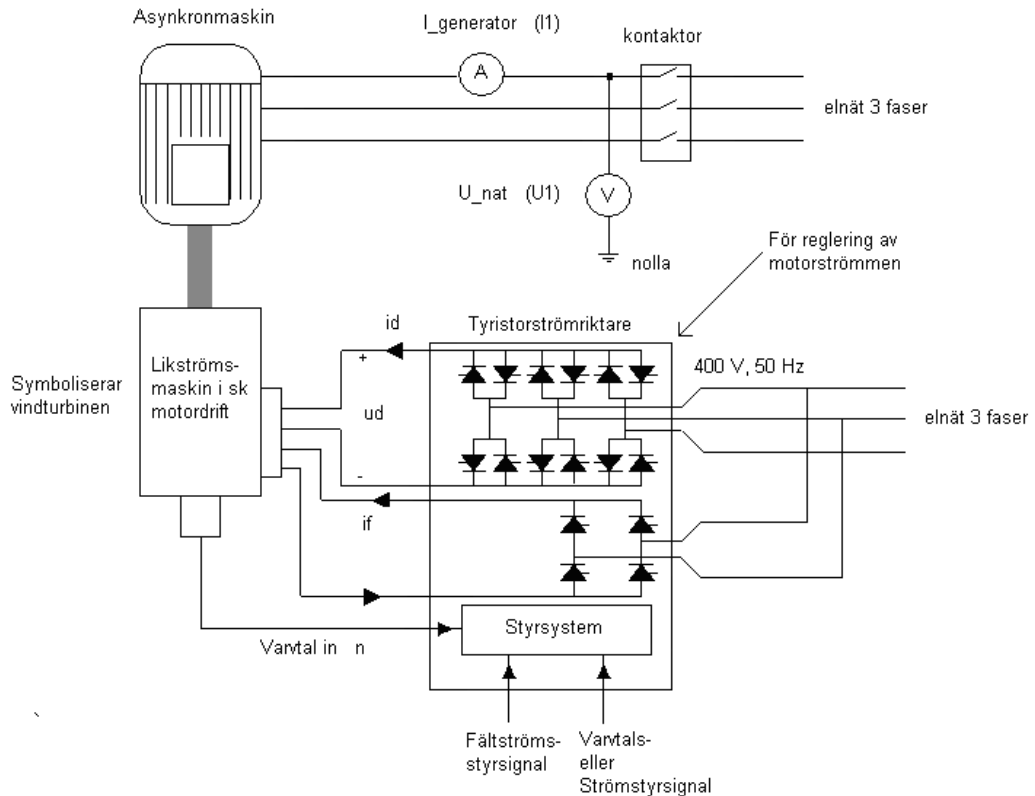

Figur 2. Uppkoppling av likströmsmaskin, asynkronmaskin och tyristorströmriktare

## Utförande

### Uppkoppling

1. Koppla in likströmsmaskin, asynkronmaskin och tyristorströmriktare enligt figur 2.
2. Anslut mät datorn analoga ingångar (AI0 – AI6) samt analoga utgång (AO0) till mätpanelens uttag enligt följande lista:

AI0	←	U_generator (u1)
AI1	←	I_generator (i1)
AI2	←	U_ankare (ud)
AI3	←	I_ankare (id)
AI4	←	I_fält (if)
AI5	←	Varvtal (n)
AO0	→	Extern styrning

3. Starta datorprogrammet
4. Kontrollera med handledaren att allt är OK.

## Koppla på nätspänningen

OBS! "Säkerhetsbandet" (fråga handledaren) skall alltid vara i "stängt" läge innan nätspänningen tillkopplas. Handledaren visar var tillkopplingsvredet för nätspänningen är placerat

1. Koppla på nätspänningen

Då mätpanelen spänningssättes tänds ett stort antal displayer. Dessa har till uppgift att förse laboranterna med information om diverse parametrar (spänning, ström, varvtal osv), som kan vara av intresse i samband med labben.

Gör Dig bekant med panelens olika funktioner.

## Starta asynkronmaskinen

1. Asynkronmaskinen startas genom att ställa **Kontaktorn** i läge "**På**". Slå därefter från kontaktorn och observera hur asynkronmaskinens hastighet avtar. Det är nu möjligt att kontrollera att rotationsriktningen är den rätta (pilen på maskinen). Det är viktigt att rotationsriktningen är korrekt med tanke på den kommande inkopplingen av likströmsmaskinen. Efter det att rotationsriktningen har kontrollerats kan man återigen koppla till kontaktorn, varvid asynkronmaskinen startar upp.

Asynkronmaskinen arbetar nu i sk "motordrift".

## Asynkronmaskinen i tomgångsdrift

Just nu arbetar asynkronmaskinen i tomgång. Detta innebär att maskinens mekaniska last är begränsad till förlusteffekten från dess egna rotation samt förlusteffekten från likströmsmaskinens rotation.

1. Avläs och skriv upp följande parametrar:

Hastighet (varv/min)	Mekanisk effekt (W), exkl förluster	Elektrisk effekt (W)
	0	

Tabell 1

Att tänka på: Varför är den elektriska effekten negativ då den mekaniska effekten är noll?

## Asynkronmaskinen som generator

Vi skall nu studera hur asynkronmaskinen kan arbeta som generator. Detta åstadkommes genom att tillföra mekanisk energi till maskinens axel. I en verklig vindturbin åstadkommes detta genom turbinens rotor. I den aktuella labben kommer detta istället att göras med hjälp av likströmsmaskinen (som arbetar som motor).

Starta nu likströmsmaskinen enligt följande (se även figur 3):

1. Välj ”Extern Styrning” med hjälp av den nedre omkopplaren vid panelfiguren för tyristoromriktare på mätpanelen. Omkopplaren skall vara riktad nedåt. Ställ omkopplaren för varvtal/ström i läge ”ström” (dvs strömstyrning)
2. Aktivera tyristorströmriktarens styrsystem genom att vrida omkopplaren från läge ”Från” till läge ”Drift”. Det tar några sekunder innan styrsystemet blir aktiverat
- 3 Justera fältströmmen to 1.5 A

Likströmsmaskinen är nu klar att leverera mekanisk effekt till asynkronmaskinen. Detta åstadkommes i laborationen genom att reglera vindhastigheten. Denna justeras med hjälp av skalreglaget på vänster sida i datorprogrammets manöverfönster.

**OBS! Viktigt!** När systemet ”Likströmsmaskin – Asynkronmaskin” skall fränkopplas, skall först likströmsmaskinen kopplas bort. Detta sker i omvänd ordning enligt ovan. Först därefter får asynkronmaskinen fränkopplas. Se sista punkten i detta Lab-PM.



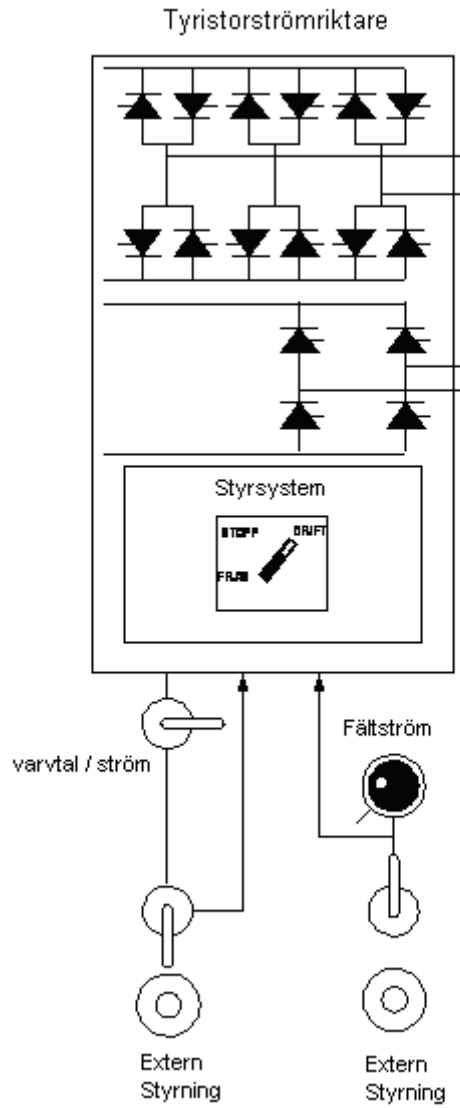

Figur 3. Tyristorströmriktarens styrsystem på kontrollpanelen

## Simulera vindturbinens driftförhållanden

Justera vindhastigheten och fyll i de olika parametrarna enligt nedanstående tabell:

Vindhastighet (m/s)	3	5	7	8	9	10	11	12	15
<b>Uppmätta storheter</b>									
Vindeffekt (W)									
Elektrisk effekt (W)									

Tabell 2

## Uppmätta vindhastigheter

Studera nu hur systemet arbetar när den manuella regleringen av vindhastighet istället styrs av en tidssekvens, bestående av uppmätta mätvärden. Omkopplaren i fältet för reglering av vindhastighet (datorskärmens manöverpanel) skiftas till läge "Uppmätta vindhastigheter". De uppmätta värdena finns lagrade i en speciell fil, vilken anropas av datorprogrammet.

## Frånkoppling av systemet

Labuppkopplingen frånkopplas enligt följande:

1. Minska vindhastigheten till 0 m/s. Detta gör att likströmsmaskinens ankarström minskas till 0
2. Ställ likströmsmaskinens fältström till 0
3. Stäng av tyristorströmriktarens styrsystem genom att vrida omkopplaren från läge "Drift" till läge "Från"
4. Stäng av assynkronmaskinen genom att vrida kontaktorn till läge "Av"

## Beräkningar

Gör beräkningar baserade på uppmätta värden enligt tabell 2 och fyll i nedanstående tabell:

Vindhastighet (m/s)	3	5	7	8	9	10	11	12	15
<b>Beräkning</b>									
Förhållandet: $\frac{\text{Elektriskeffekt}}{\text{Vindeffekt}}$									

Tabell 3

## Plottning av kurvor

1. Plotta Elektrisk effekt som funktion av Vindhastighet (se tabell 2 och diagram 1)
2. Plotta förhållandet  $\frac{\text{Elektriskeffekt}}{\text{Vindeffekt}}$  som funktion av Vindhastighet (se tabell 3 och diagram 2)

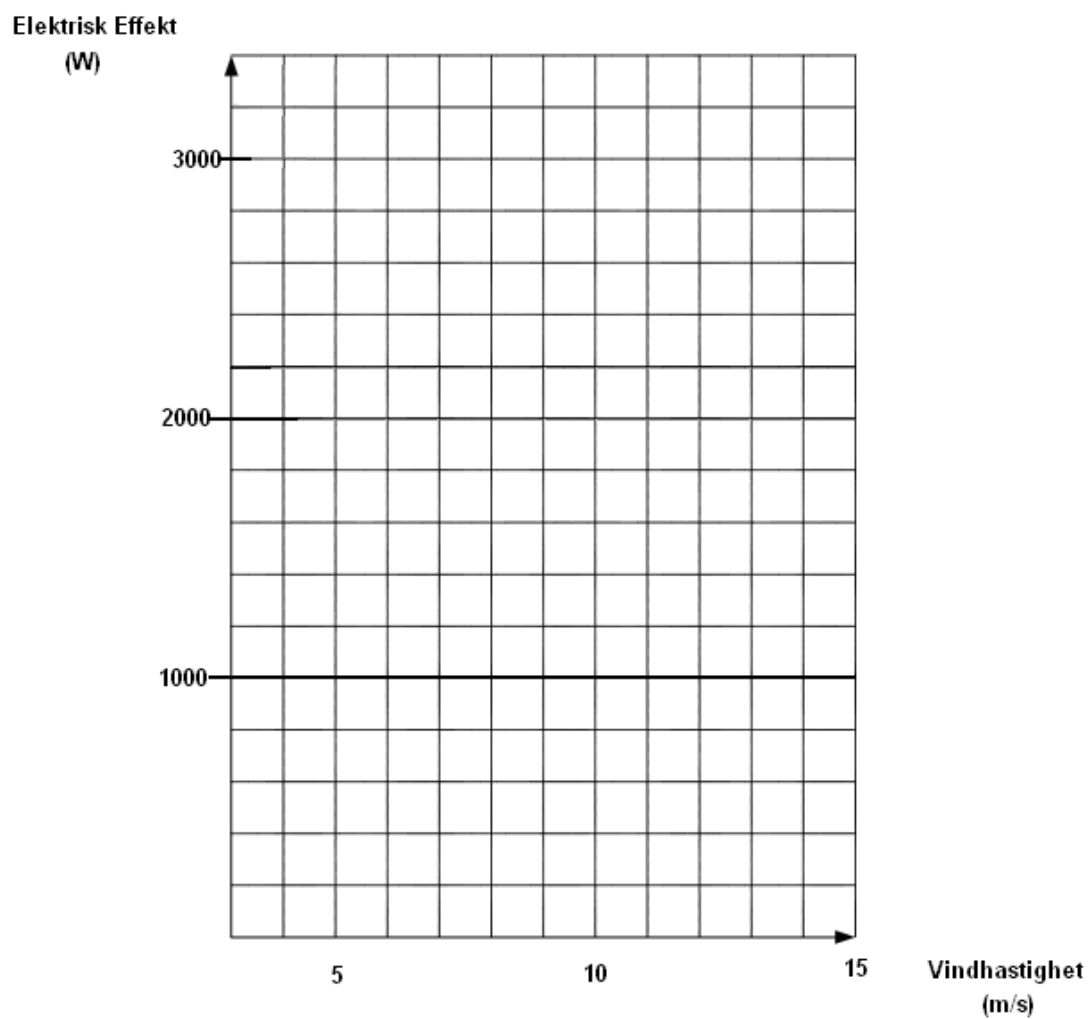

Diagram 1

- Att tänka på: - Varför böjer kurvan av på slutet?  
 - Om kurvan inte böjde av, vad skulle det innebära för ett vindkraftverk i hård vind?

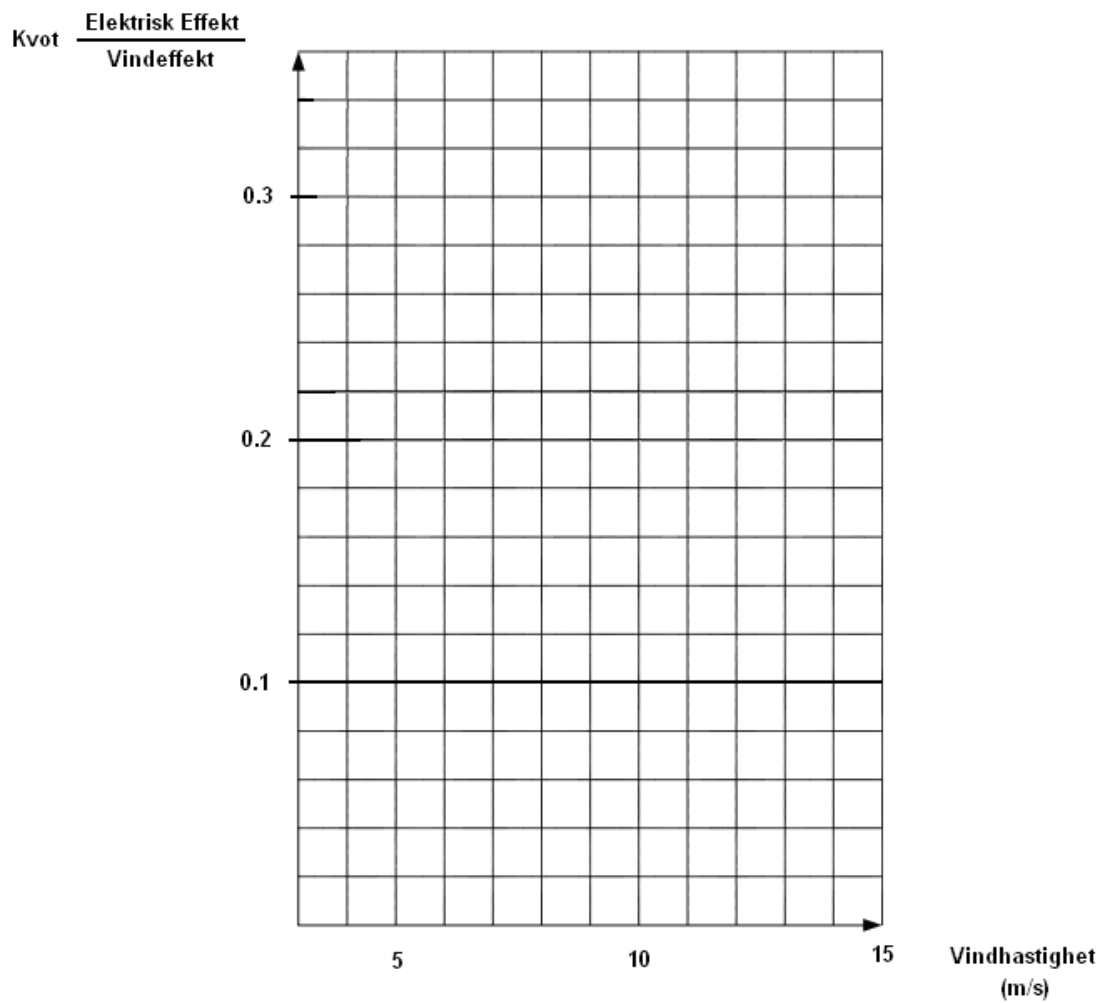

Diagram 2

- Att tänka på:
- Vad betyder en låg kvot?
  - Vad tror Du den låga kvoten beror på?
    - a) vindturbinens egenskaper
    - b) förluster i generatorn
    - c) lagren bromsar mycket



C-2

*Wind Energy Exercise Part 1: Wind Energy Potential*







---

## **Miljövänliga Energikällor (EEK 231)**

### Wind Energy Exercise Part 1: Wind Energy Potential

Course Examiner : Ola Carlson

Tutor : Abram Perdana

Submission deadline : 2008-04-16

Electric Power Engineering  
Department of Energy and Environment  
CHALMERS UNIVERSITY OF TECHNOLOGY  
Göteborg, 2007



## 1. Introduction

This exercise is to provide basic knowledge on wind energy estimation. In order to do this exercise, you need to use the Matlab file given (WindEnergy.m).

## 2. Wind Speed Distribution

Wind speed distribution throughout a year is estimated using the Weibull function given by

$$f(w) = \left(\frac{k}{C}\right) \left(\frac{w}{C}\right)^{k-1} \exp\left[-\left(\frac{w}{C}\right)^k\right] \quad (1)$$

The equation above expresses the probability  $f(w)$  to have a wind speed  $w$  during the year, where  $k$  is the shape factor, with  $k > 1$ .  $C$  is the scale factor, which is calculated from the following equation

$$C = \frac{\bar{w}}{\Gamma\left(1 + \frac{1}{k}\right)} \quad (2)$$

where  $\bar{w}$  is the average wind speed, and  $\Gamma$  is the gamma function.

In this exercise, let's assume the average wind speed is 6 m/s.

**Task 1:** Plot the wind speed distribution for average wind speed of 6 m/s.

**Question 1:** Is the most frequently occurring wind speed the same as the average wind speed? If the answer is no, explain why?

**Question 2:** Prove (numerically) that the wind speed distribution given in Task 1 has an average value of 6 m/s!

### 3. Wind Power Density

The power contained in wind stream per square meter of area is given by

$$P(w) = 0.5 \rho w^3 \quad (3)$$

where  $\rho$  is the air density.

In order to estimate the distribution of wind energy at different wind speed, or so-called wind energy distribution, the following formula is used:

$$E(w) = f(w)P(w) \quad (4)$$

It is easier to comprehend the wind speed and wind energy distribution by transforming the probability value into the duration per year.

**Task 2:** Plot the wind speed distribution you made in Task 1 with y-axis representing the duration per year (in hours/year). Plot the wind energy distribution as well (in kWh/year).

**Question 3:** Which wind speed gives the most energy? What is the implication of this?

The wind power density  $P_D$ , measured in watts per square meter, indicates how much power is available at the site for conversion by a wind turbine. The wind power density can be calculated as:

$$P_D = \frac{1}{T} \int_0^{\infty} E(w) dw \quad (5)$$

where  $T$  is the number of hours in a year.

**Question 4:** What is the wind power density for a site with the wind speed data given in Task 2? Compare the result with the wind power density calculated based solely on the wind speed average.!

**Question 5:** How much wind energy is available for a site with average wind speed of 7 m/s? Compare the result with your answer in Question 4! What is your comment on it?

#### 4. Wind shear

Wind speed at hub height is normally significantly higher than wind speed at the anemometer height. Just to give an idea, normally an anemometer height is 10 m and a wind turbine hub height is between 30-90 meter.

One model to estimate wind speed at hub height using wind speed data obtained from anemometer height is described by the following expression:

$$\frac{\bar{w}}{\bar{w}_0} = \left( \frac{h}{h_0} \right)^a \quad (6)$$

where  $\bar{w}$  is the average wind speed at hub height  $h$ ,  $\bar{w}_0$  is the average wind speed at anemometer height  $h_0$ , and  $a$  is the wind shear exponent.

**Task 3:** Plot wind speed vs height for a site with average wind speed given in Task 1, assumed that the anemometer height is 20 meter and shear component is 0.2.

**Question 6:** Using information obtained from Task 3, calculate how much is the annual energy difference (in kWh/m<sup>2</sup>) between wind speed measured at 50 meter compared to the one measured at 20 m?

## 5. Wind turbine power curve

Regarding the rotational speed, wind turbines can be categorized into fixed-speed and variable-speed wind turbines. The typical power curve of the two wind turbine types is shown in the following figure.

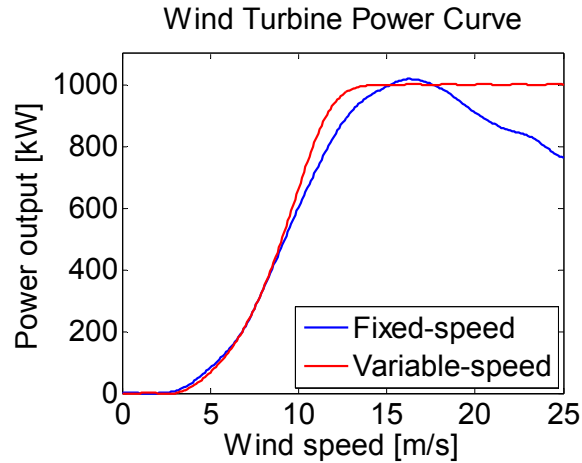

**Question 7:** Compare the annual energy production between the fixed-speed and the variable-speed wind turbines given in the figure above. Assume that the hub height is 50 meter and use wind data obtained from Question 6.

## 6. Energy curve

The wind turbine energy curve provides information on the total amount of energy a wind turbine produces over a range of annual average wind speeds.

$$E_w = T \int_0^{\infty} P_T(w) f(w) dw \quad (7)$$

**Task 4:** Plot energy curve for the variable-speed wind turbine!

**Question 8:** Why does the annual energy production decrease for average wind speed higher than 15 m/s?.

## C-3

### *Wind Energy Exercise Part 2: Wind Turbine Control*







Chalmers Test Turbine at Hönö.

---

## **Miljövänliga Energikällor (EEK 231)**

Wind Energy Exercise Part 2:

Wind Turbine Control

Course Examiner : Ola Carlson  
Tutor : Abram Perdana  
Submission deadline : 2008-04-23

Original version of the exercise manual was  
prepared by Magnus Ellsén

Electric Power Engineering  
Department of Energy and Environment  
CHALMERS UNIVERSITY OF TECHNOLOGY  
Göteborg, 2007

## 1. Introduction

The exercise will be done as a computer exercise. The objective of this exercise is to gain understanding on how the wind turbine and its control system work. This is achieved by investigating some basic theories of wind turbine engineering, plotting graphs on some calculated values, and then analyzing measurement data. By looking at different plots of measurement data, it is possible to distinguish the different operation modes of the wind turbine controller. Finally the theoretical and measured data is compared.

*Question 1: Which type of wind turbine are we using in this exercise?*

## 2. Basic Theory of Wind Energy Conversion

The turbine mechanical power can be expressed as

$$P_{mec} = \frac{1}{2} \rho C_p A v_w^3$$

The tip speed ratio (TSR) or  $\lambda$  is defined as:

$$\lambda = \frac{v_{tip}}{v_w}$$

Abbreviations of the variables can be found in Appendix A. From turbine data, a theoretical curve with power coefficient as a function of TSR could be derived. The same curve could also be experimentally measured. The power coefficient curve for this turbine is provided in Appendix C. The tasks and questions given in this exercise help you to understand on how the turbine mechanical power is affected by the TSR.

*Question 2: What is the optimal TSR of the turbine?*

## 3. Working with Matlab Files

The Matlab and data files can be downloaded from the course web page. You should follow the steps below to utilize the Matlab files provided.

1. Unzip the files and put them in your work folder.
2. Start Matlab and set the working directory to your folder.
3. Open the file `Lab1.m` in the matlab m-file editor.
4. Replace the question marks in the `Lab1.m` file with appropriate expressions and solve the tasks.

5. Save the modified file as `Lab1.m` in your folder. In the end of the exercise, you will have everything gathered so you need only one command to solve assignments and get all graphs you need.
6. In order to avoid error messages from uncompleted parts of `Lab1.m`, you must comment all rows below the assignment you are working at. It could easily be done in the Matlab editor by marking the rows you wish to comment/uncomment and then chose menu `Text → Comment/Uncomment`.

Do not forget to put dot (`.`) before element wise multiplication (`*`) and division (`/`) of a vector. For example:

```
Pel = (DCC .* DCV) ./ 1000;    % Electrical power [kW]
```

Let us start with having a look at how much power is available from the turbine at different wind speeds. In this exercise it assumed that the turbine speed is adapted to the wind speed in a way that gives maximum power from the turbine.

***Task 1:** Calculate the theoretical maximum mechanical power on the turbine shaft, and plot mechanical power  $P_{mec}$  on the y-axis and wind speed  $v_w$  on the x-axis. Assume that the turbine is working at optimal TSR over the whole wind speed range. Note: the mechanical power plotted in kW.*

The most straightforward strategy to keep the turbine running at optimal TSR is to measure the wind speed  $v_w$  and calculate the appropriate turbine speed and then assign a controller to achieve that speed. However in practice this strategy is seldom used since it puts up some difficulties.

***Question 3:** What are the difficulties of controlling turbine speed by measuring wind speed directly?*

Rather than measuring wind speed directly by using anemometer, the turbine speed can be used as a wind speed sensor instead. The controller uses the turbine rotor speed as an input. Based on this speed input, the controller calculates an appropriate load torque. If this is done correctly, the rotor speed will adapt to the wind speed in a way that it keeps the TSR at its optimum value.

***Task 2:** Find the function that calculates the torque control value to the generator electrical system, to keep TSR at an optimum value, with rotor speed as an input.*

$$T = f(n)$$

*In a new figure, plot the calculated torque in kNm on the y-axis as a function of rotor speed,  $n$ .*

*Hints:*

$$P = T\omega$$

$$v_{tip} = r\omega$$

*T = f(n) can be derived from the formulas given previously.*

## 4. Measurements

To take a measurement on the wind turbine power as a function of wind speed (power curve), the data must be averaged. The wind speed signal comes from an anemometer in a mast located in front of the wind turbine. In most weather conditions wind speed varies considerably from one second to the next; and from one position to another. This means there is a poor correspondence between a single instantaneous wind speed value and a power reading taken at the same time. An additional error source is that the wind with the measured speed hits the turbine with a slight delay depending on the distance between the anemometer mast and the turbine.

A common procedure is to measure instantaneous values of wind speed, rotor speed and electrical power at a rate of 1 sample/second. These values are then averaged into 1 minute or 10 minute average values.

To have a complete power curve, the measurements must cover the whole wind speed range of interest. The wind must also blow from a limited sector where the anemometer mast is in front of the turbine. Normally it takes at least a month of measurements to build a complete and accurate database. Measurements in the correct wind sector must be sorted out, and the valid data from different measurements must be merged.

Just like in cooking programs on TV, all the data you need have been prepared in advance. The database available is collected from some of the measurements during the period June to November 2002. It consists of 5693 one-minute averages from 28 measurement channels. When you run `Lab1.m` file, the database (including a time channel vector, which can not be used since the data consists of several time series merged together) will be loaded in the form of a 5693x29 matrix assigned in variable name `lokal`. The matrix `lokal` will also be split into one vector of 5693x1 for each channel. The names of the signals are in short form. The signals you will need are the following:

RSA	Rotor Speed Analog [1/min]	This is the turbine speed.
DCV	DC link Voltage [V]	Voltage from the rectifier.
DCC	DC link Current [A]	Current from the rectifier.
WS1	Wind Speed 1. Wind speed at hub height in the meteorological mast adjacent to the turbine. [m/s]	

**Task 3:** Plot a power coefficient curve from measured values. The power coefficient curve can be derived from the measured values. This can then be compared with the one given in Appendix C. Calculate also TSR and  $C_p$  from the measured data.

To calculate  $C_p$ , you need turbine shaft mechanical power. It is obtained as follow: First the electrical power is calculated as DC voltage multiply by DC current. Then the mechanical power is calculated assuming an efficiency of 85% for the generator and the rectifier.

## 5. Mechanical Power Calculation

The generator system is converting mechanical power into electrical power. In the generator system there are losses, so the output power should be less than the input power.

The efficiency of the generator and rectifier is regarded to be  $\eta=0.85$  (as stated in Assignment 3). The efficiency is the relation between the output power and the input power of the system. To calculate the mechanical power from the electrical power, the relation will be like this:

$$\eta = \frac{P_{el}}{P_{mec}}$$

TSR and  $C_p$  are then being plotted against each other as small dots in Matlab-generated figure 3. The average curve of all the dots are also automatically being plotted in the same figure. See explanation below.

In the template `Lab1.m` file, two more curves are generated automatically. These are rotor speed as a function of wind speed, and TSR as a function of wind speed.

As you can see, the one-minute averaged data points are sometimes widely spread. To be able to read anything from the graph accurately, the data points have to be averaged again. This is done with "the method of bins". The idea is to divide the data into equally spaced groups or bins along the x-axis. The data points in each bin are averaged both in x-wise and y-wise direction. This gives one averaged point in each bin. These points build the averaged curve. A function that applies this method to the data is available in the template.

**Task 4:** Plot mechanical power against wind speed. Average with the method of bins. Plot the averaged curve in the same figure as the theoretical one from Task 1.

**Task 5:** Calculate the torque,  $T$ , on the turbine shaft. Plot it in the same figure as the optimal torque curve from assignment 2.

## 6. Results Evaluation

Before you try to understand what is going on in the graphs of the measured values, first you have to know the control principles of the generator. The control principles are described in Appendix D. Note that there are several different rotor speed regulator modes involved. The different regulator or controller modes are engaged one at a time.

Which controller that is selected for the moment depends on the rotor speed. When you study the various plots of the measured data, try to identify each control region as described in Appendix D and evaluate and give comments on them separately.

You should make comments to the graphs about the questions below.

*Question 4. Does the measured power coefficient curve in Matlab-generated figure 3 matches the curve given in the Appendix C?*

*Question 5. Why is there a very large difference between the measured and the calculated power curve for wind speed higher than approximately 8 m/s, as plotted in Matlab-generated figure 1?*

*Question 6. In Matlab-generated figure 2, 4 and 5, try to identify the different regions of the measured data that relates to the different controller modes. Are the different controllers working as expected? Could any improvements be done? If so, give your suggestions.*

## 7. Report

The exercise should be concluded in a short technical report (ca 4-8 pages, however this number of pages is not compulsory). The report should include the following parts:

- Introduction and objectives of the work.
- Short description of the wind turbine working principle consisting both energy conversion and the regulation/control.
- Assignments results together with associated graphs.
- General evaluations and conclusions of the exercise.
- Appendix, which consists of the Lab1.m file and other information if needed.

The report can be done in groups, max. 2 persons each group. The report should be handed in to Abram Perdana in paper format (see cover page for the date). Should you have questions, please feel free to contact Abram directly or by email (abram.perdana@chalmers.se).

## Appendix A: Abbreviations and Constant Values

$\rho$	air density = 1.225 [kg/m <sup>3</sup> ]
$A$	rotor swept area = $\pi r^2$ [m <sup>2</sup> ]
$r$	rotor radius = 13.5 / 2 [m]
$C_p$	power coefficient (Similar to turbine efficiency. Theoretical max for a 100% efficient turbine, without any tube around it, is 16/27 (about 59%) according to Betz' law. (Swedish: effektkoefficient)
$C_{pmax}$	maximum Power Coefficient (For a particular turbine. $C_{pmax} \leq 59\%$ )
$\lambda$ or $TSR$	tip speed ratio (sw: löptal)
$\lambda_{opt}$	$\lambda$ for $C_{pmax}$
$\omega$	turbine angular speed [rad/s]
$n$	rotor speed [1/min] = $\omega \frac{60}{2\pi}$
$T$	turbine shaft torque [Nm] (sw: turbinaxelvridmoment)
$P_{mec}$	mechanical power on turbine shaft [W]
$P_{el}$	electrical power output from the generator rectifier.
$v_w$	wind speed [m/s]
$v_{tip}$	blade tip speed [m/s] (sw: spetskastighet)

## Appendix B: Wind Turbine Data and Components

### Data:

- Turbine diameter 13,5 m
- Teeter hub
- Direct driven (gearless)
- Steel tower, 18 m
- Variable speed
- Fixed pitch, stall control.

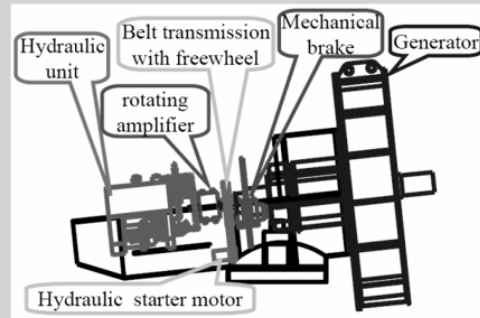

### Direct driven Permanent Magnet Generator:

- Experimental generator designed by Prof. Ed Spooner, Univ. of Durham, Prof. Alan Williamson, Univ. Of Manchester and Mr. Les Thompson, MEC Electrical Machines, UK
- Pre study for a large scale generator.
- Part of an EC project.

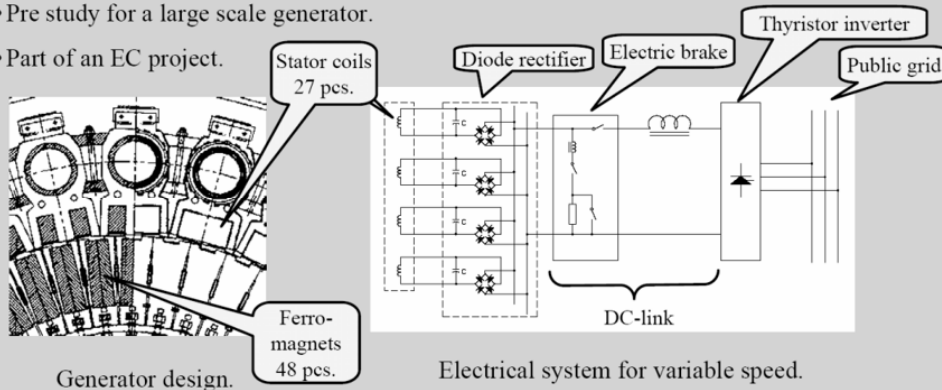

Electrical system for variable speed.  
Rated power: 30 kW at 70 rpm.

### Measurement and Control system

- Large number of transducers, e.g. Currents, voltages, tower forces, main shaft torque, generator temperature, meteorological parameters.
- Flexible
- Available for a large number of experiments, like active damping.
- PC-based system
- User friendly interface.

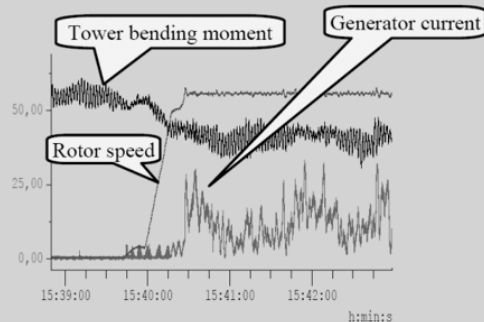

Rotor speed control test.



## Appendix C: Turbine Blades and $C_p$ - $\lambda$ curve

# The Hönö blades

Manufactured in solid wood (Thuja Plicata)

NACA 63-2xx and FFA-W3-xxx airfoils

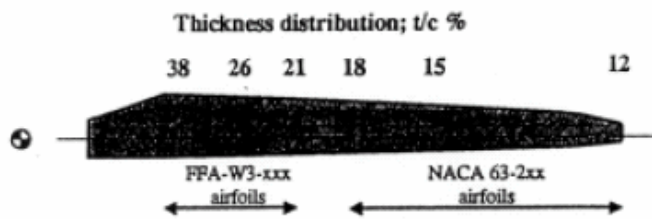

## $C_p$ - $\lambda$ curve

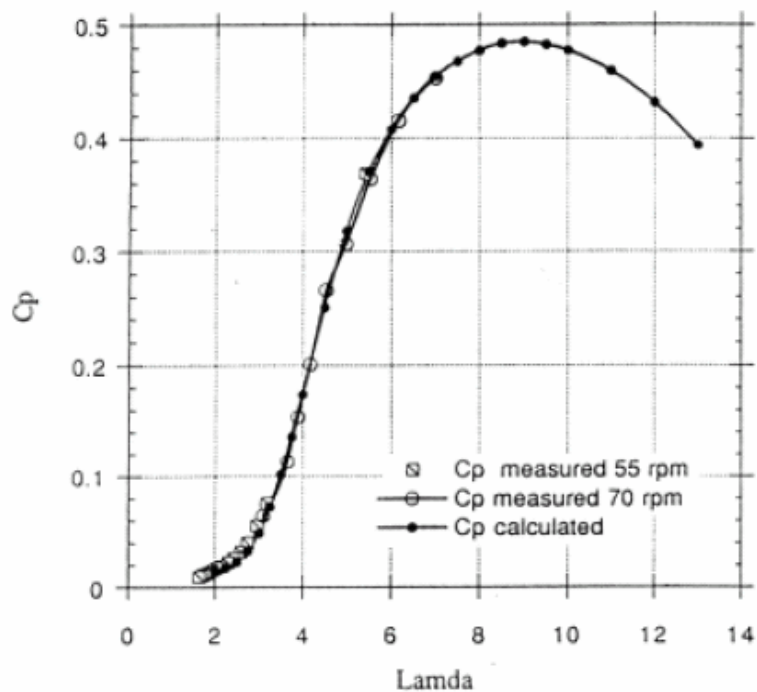

## Appendix D: Controller

Figure D1 shows the main controllers of the wind turbine system. The controllers operate according to the following sequence:

The control computer takes a generator speed and voltage measurement. It then calculates a current demand in one of the speed controller modes as described later on. There is an approximately linear relationship between the generator current and torque. The current demand is then sent to the thyristor inverter in the generator electrical system. Inside the thyristor converter there is another controller trying to achieve that current on the DC-link. This sequence occurs continuously with frequency at ten times per seconds.

The more current that is taken from the DC-link, the more loaded the generator will be, and more power will be sent out on the public grid. If the current is too high compared to the wind speed, the turbine will run too slow or even stop. The power to the grid then will drop because the voltage on the DC-link drops when the generator runs slower.

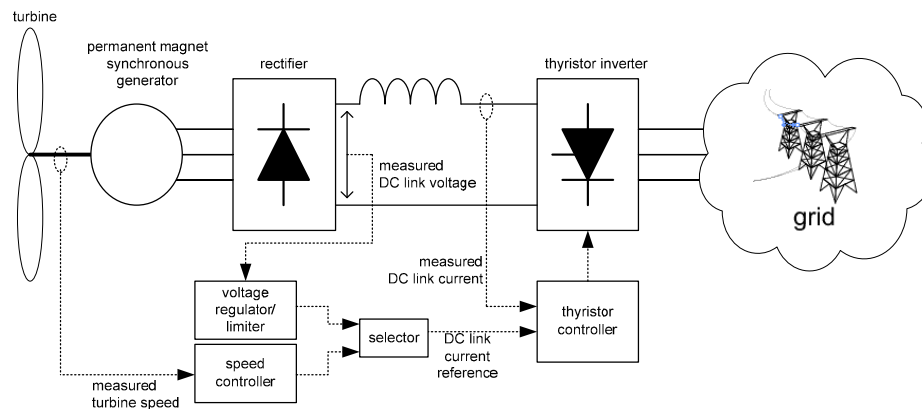

Figure D1. Overview of the WT control principle

### Speed Control Modes

As shown in Figure D2 (clearer figure can be found in file Appendix.pdf), the speed controller has five different modes of operation as follows:

**Standby mode:** No load applied below 50 rpm. The objective is to prevent the turbine from stopping too often at low winds. If the wind dies completely for a few seconds the inertia in the turbine will be enough to prevent the rotor speed to drop below the parking speed limit. If the speed drops below the parking speed limit, the control system parks the turbine, and the starter motor must be engaged when the wind picks up again.

**Ramp up mode:** The objective of this controller is to act as a smooth transition between the Standby and optimal controller mode.

**Optimal mode:** In this mode, the controller tries to maximize the energy capture from the turbine by applying a torque dependent on the rotor speed in such a way that the turbine will operate at its optimal tip speed ratio. The idea is that if the wind

speed changes, the incoming torque from the turbine will be affected. The speed of the turbine will then change. If the speed changes, the optimal controller adjusts the generator torque. When the turbine torque and the generator torque become equal, a new stable operation point is achieved. In reality the wind speed varies almost all the time, and the rotor speed tries to follow to keep the tip speed ratio constant.

**Stall mode:** This controller limits the maximum speed of the turbine. This mode is engaged when the turbine speed reaches the stall speed set point. In this exercise it was set to 72 rpm. The objective of the stall controller is to prevent over speeding of the generator and turbine. The turbine is designed to operate at maximum 75 rpm with some margin. At about 150 rpm the blades will break and fly off.

The generator voltage is dependent on the rotational speed. The generator and its electrical system (reactive power compensation capacitors, rectifier, thyristor converter) were designed to operate at a voltage level that is reached at no load and about 70 rpm. When the generator is loaded the voltage drops slightly. At full load the maximum voltage level is reached at about 80 rpm. So the maximum allowed speed of the generator is dependent on the load but should not exceed 80 rpm.

Another reason for limiting the turbine speed is to limit the incoming power and shaft torque from the turbine at high wind speeds. The maximum torque the generator can produce is approximately equal to the incoming torque from the turbine at 80 rpm. That is if the wind speed happens to give the optimal tip speed ratio at that point. If the generator speed is allowed any higher than that, only the mechanical brake can provide a torque that is big enough to bring the speed down.

On a normal induction generator, the peak torque is much higher than the rated torque. The problem for an induction generator would instead be overheating if it is operated for a long time at a power level higher than the rated level.

**Retard mode:** This mode is engaged manually, or by the supervisor program, and is the normal way to stop the turbine.

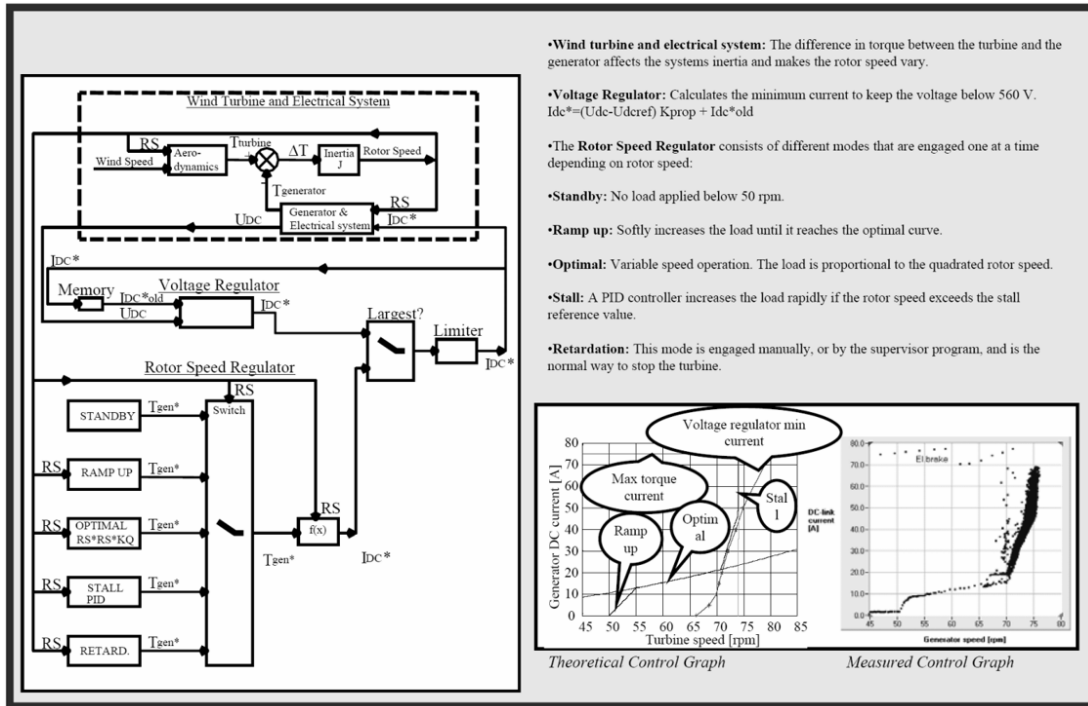

Figure D2. Different control modes and the associated operating region.

## Voltage controller

If the stall controller set point is set higher than about 70 rpm there is a risk of over voltage if the load is not large enough. The voltage controller measures the voltage and adds an appropriate amount of current for the next control loop if the voltage approaches the maximum limit. The voltage controller is engaged all the time independent of the rotor speed. It works side by side with one of the rotor speed regulators above. Of course only one control value can be sent to the electrical system each control loop. Therefore the voltage controller value and the speed regulator value are compared. The highest value is sent to the electrical system. In this exercise the impact of the voltage controller is hardly visible in the graphs since the stall speed is set to 72 rpm.