

THESIS FOR THE DEGREE OF DOCTOR OF PHILOSOPHY

On Some Aspects of Design of Electric Power Ancillary Service Markets

JIN ZHONG



Department of Electric Power Engineering
CHALMERS UNIVERSITY OF TECHNOLOGY
Göteborg, Sweden 2003

On Some Aspects of Design of Electric Power Ancillary Service Markets
JIN ZHONG
ISBN 91-7291-254-5

© JIN ZHONG, 2003

Doktorsavhandlingar vid Chalmers tekniska högskola
Ny serie nr 1936
ISSN 0346-718x

Technical report - School of Electrical Engineering,
Chalmers University of Technology
ISSN 1651-498x/438

Department of Electric Power Engineering
Chalmers University of Technology
SE-412 96 Göteborg
Sweden
Telephone +46 (0)31-772 1000

Chalmers Bibliotek, Reproservice
Göteborg, 2003

On Some Aspects of Design of Electric Power Ancillary Service Markets

JIN ZHONG

Department of Electric Power Engineering

Chalmers University of Technology

ABSTRACT

Ancillary services are defined as all those activities on the interconnected grid that are necessary to support the transmission of power while maintaining reliable operation and ensuring the required degree of quality and safety. There are several activities of the operator that come under the preview of ancillary services. The definitions of some services and distinctions between some of them are often unclear.

This thesis attempts to examine three of the most important ancillary services provided by the independent system operator in a deregulated power system, that of maintaining the system voltage profile within acceptable limits, the system frequency around the nominal value and enough of spinning reserves to maintain the system security. A broad overview of how reactive power, spinning reserves and frequency regulation services are managed by the system operator in deregulated electricity markets around the world has been provided in the thesis. Subsequently, the thesis proposes models for participants in reactive power, spinning reserve and frequency regulation service markets to submit their offers. The thesis further deals with the optimal procurement of these ancillary services by the independent system operator. The optimal procurement schemes seek to achieve the most beneficial plan for the system, from both technical and economical perspectives. It is observed that the classical models for reactive power optimization or frequency control need to be refined and adjusted to suit the requirements of present day competitive electricity markets.

Keywords: deregulation, electricity market, ancillary services, reactive power, spinning reserve, frequency regulation and optimal power flow.

ACKNOWLEDGMENTS

The author expresses her deepest gratitude to her supervisor, Associate Professor Kankar Bhattacharya, for his constructive guidance, fruitful discussions and encouragement throughout this work. The valuable discussions with Professor Jaap Daalder are also greatly appreciated.

The financial support received from Sydkraft Research Foundation to carry out the work is gratefully acknowledged. Mr. Alf Larsen of Sydkraft Elnät Syd, Mr. Bernt Hansson of Vattenfall, Mr. Klas Roudén of Svenska Kraftnät, and Dr. Balbir Singh from Institute for Research in Economics and Business Administration, Norway, comprised the four-member Project Reference Group. The author appreciates their inputs during the course of this work.

Special thanks to Professor Anjan Bose of Washington State University for his precious comments and supervision when the author was a visiting student at Washington State University. Also many thanks to Emilia Nobile for her kindly help on author's work and life at Washington State University.

Finally, the author wishes to thank all the colleagues at the Department of Electric Power Engineering, Chalmers University of Technology, especially the power systems group, for cooperation and a lively working environment.

LIST OF PUBLICATIONS

This thesis is based on the work contained in the following papers:

- I. J. Zhong and K. Bhattacharya, "Toward a competitive market for reactive power," *IEEE Transactions on Power Systems*, Vol.17, No.4, November 2002, pp.1206-1215.
- II. K. Bhattacharya and J. Zhong, "Closure to Discussion by Carson Taylor, on Reactive Power as an Ancillary Service", *IEEE Transactions on Power Systems*, Vol.17, No.2, May 2002, pp. 523-524.
- III. K. Bhattacharya and J. Zhong, "Reactive power as an ancillary service," *IEEE Transactions on Power Systems*, Vol.16, No.2, May 2001, pp. 294-300.
 - *This paper was also presented at IEEE/PES 22nd Power Industry Computer Applications Conference (PICA), Sydney, Australia, May 2001.*
 - *This paper was also presented at 6th Electric Power Control Centers Workshop held at Opio, France in June 2001.*
- IV. J. Zhong and K. Bhattacharya, "Design of competitive markets for spinning reserve services," Proceedings of IEEE/PES Summer Meeting, Chicago, IL, July 2002, pp. 1627-1632.
- V. J. Zhong and K. Bhattacharya, "Reactive power management in deregulated electricity markets— A Review," Proceedings of IEEE/PES Winter Meeting, New York, NY, January 2002, pp.1287 - 1292.
- VI. J. Zhong, K. Bhattacharya and J. Daalder, "Design of ancillary service markets: Reactive power and frequency regulation," Proceedings of International Symposium on Bulk Power Systems Dynamics and Control, Onomichi City, Japan, August 2001, pp. 135-142.
- VII. J. Zhong⁺ and K. Bhattacharya, "Automatic balance service for frequency regulation," presented at IEEE/PES Transmission and Distribution Conference and Exposition, for student paper competition, Atlanta, GA, October 2001.

⁺ This paper received the First Prize in the Student Research Paper Competition, *IEEE Power Engineering Society Transmission and Distribution Conference and Exposition*, Atlanta, USA, October 2001.

- VIII. J. Zhong and K. Bhattacharya, "Optimum VAr support procurement for maintenance of contracted transactions," Proceedings of International Conference on Electric Utility Deregulation, Restructuring and Power Technologies (DRPT2000), London, April 2000, pp. 636-641.
- IX. J. Zhong, K. Bhattacharya and J. Daalder, "Reactive power as an ancillary service: Issues in optimal procurement," Proceedings of IEEE-PES/CSEE International Conference on Power System Technology (POWERCON), Perth, Australia, December 2000, pp. 885-890.
- X. J. Zhong, E. Nobile, A. Bose and K. Bhattacharya, "Localized Reactive Power Markets using the Concept of Voltage Control Areas", *IEEE Transactions on Power Systems* (communicated).
- XI. J. Zhong and K. Bhattacharya, "Frequency Linked Pricing as an Instrument for Frequency Regulation in Deregulated Electricity Markets", IEEE Power Engineering Society General Meeting, Toronto, Ontario Canada, July 13-17 (communicated).

LIST OF SYMBOLS

i, j	Index for buses
k	Index for time period
g	Index for generators
gen	Index for generators
ng	Index for load bus
a_o	Availability price offer, in \$
C_L	The economic worth of reduced loss
D_{PR}	Primary regulation requirement for a control area
D_{SR}	Secondary regulation requirement for a control area
E_{af}	Excitation voltage, p.u.
f	System frequency, Hz
G	Conductance of line, p.u.
I_a	Steady-state armature current, p.u.
K_P	Plant gain, $K_P=1/D$ where D is the load-frequency constant
LF	Loss factor at a bus
m_1	Cost of loss price offer for operating in under-excited mode (absorb reactive power), $Q_{Min} \leq Q \leq 0$, \$/MVArh
m_2	Cost of loss price offer for operating in the region $Q_{Base} \leq Q \leq Q_A$, \$/MVArh
m_3Q	Opportunity price offer for operating in the region $Q_A \leq Q \leq Q_B$, (\$/MVArh)/MVArh
P	Real power, MW or p.u.
P_R	The real power corresponding to machine rating power, p.u.
PG^{Con}	Contracted real power generation, p.u.
P_{GEN}	Scheduled generation from a generating unit, MW
$P_{GEN,Actual}$	Actual generation from a unit after spinning reserve has been activated, MW
P_{LOAD}	Load at a bus, MW
P_{MAX}	Maximum generation capacity of generator, MW
P_{SRS}	Quantity of spinning reserve service cleared in the spinning reserve service market, MW
P_{PR}	Primary frequency regulation market price, \$/MWh-Hz
P_{SR}	Secondary frequency regulation market price, (\$/MWh)/MWh
Q	Reactive Power, MVA or p.u.
QD	Reactive power demand, p.u.
QC	Reactive power support from shunt capacitors, p.u.
Q_{Base}	Reactive power required by generator for its auxiliary equipment

Q_{Min}	Lower limit of reactive power generation
RAMP	Ramp rate of a generator, MW/hour
SR_{Cap}	Spinning reserve capacity made available to ISO, MW
SRES	Total system spinning reserves available at an hour, MW
TSR	Total spinning reserve requirement for the system, MW
T_P	Plant time-constant, $T_P=2H/fD$, where H is the inertia-constant
T_g	Speed governor time-constant, in seconds
T_T	Steam-chest time-constant, in seconds
U_{PR}	Binary variable for selection of primary regulation bid
U_{SR}	Binary variable for selection of secondary regulation bid
V	Bus voltage, p.u.
V_t	Voltage at the generator terminal bus, p.u.
W	Integer variable (1 = selected, 0 = not selected)
W_0	The binary variables for the discrete selection of a reactive power component if it is selected from any Region
W_1	The binary variables for the discrete selection of a reactive power component from Region-I
W_2	The binary variables for the discrete selection of a reactive power component from Region-II
W_3	The binary variables for the discrete selection of a reactive power component from Region-III
X	Reactance of a transmission line, p.u
X_S	Synchronous reactance, p.u.
$XP_{i,\text{gen}}^{\text{con}}$	The contracted real power transactions by load at bus i and generator gen .
$XP_{i,\text{gen}}$	Actual real power transaction between load at bus i and generator, gen
Y	Element of network and admittance matrix, p.u.
θ	Angle associated with Y, radians
δ	Voltage angle, radians
ρ	Uniform market price for spinning reserve
ρ_0	The uniform availability price for reactive power
ρ_1	The uniform cost of loss price when producing reactive power
ρ_2	The uniform cost of loss price when absorbing reactive power
ρ_3	The uniform opportunity price for reactive power
λ	Dual of the nodal reactive power balance constraint
γ	Dual of the generator reactive power capability constraint
μ	Dual of the under excitation constraint on reactive power generation

β	Offer price for spinning reserve service, \$/MWh
γ_{PR}	Primary frequency regulation quantity offer, p.u.MW/(\$/MWh)
η_{PR}	Primary frequency regulation price offer, \$/MWh-Hz
γ_{SR}	Secondary frequency regulation quantity offer, p.u.MW/(\$/MWh)
η_{SR}	Secondary frequency regulation price offer, (\$/MWh)/MWh
$\Delta\rho$	Frequency linked pricing signal for control, \$/MWh
ΔP	Generation increase or decrease in frequency control, p.u.MW

ABBREVIATIONS AND ACRONYMS

ABS	Automatic Balance Services
ACE	Area Control Error
AGC	Automatic Generation Control
EDF	Electricite de France
EPF	Expected Payment Function
ISO	Independent System Operator
NEMMCO	National Electricity Market Management Company, Australia
NERC	North American Electric Reliability Council
NGC	National Grid Company, UK
Nordel	Comprising ISOs from Sweden, Norway, Denmark, Finland and Iceland
NYISO	New York ISO
PJM	Pennsylvania-New Jersey-Maryland
SAF	Societal Advantage Function
SRS	Spinning Reserve Service
TSO	Transmission System Operator

Table of Contents

CHAPTER 1 INTRODUCTION.....	1
1.1 POWER INDUSTRY DEREGULATION AND EMERGENCE OF ANCILLARY SERVICES.....	1
1.1.1 Ancillary Services as seen by Customers, Power Producers and the Operators	2
1.1.2 Ancillary Services' Classifications and Definitions	3
1.1.3 Scope of this Work	4
1.2 GLOBAL OVERVIEW OF ANCILLARY SERVICE MANAGEMENT.....	5
1.2.1 New York ISO.....	5
1.2.2 California ISO	8
1.2.3 PJM Interconnection	9
1.2.4 United Kingdom.....	10
1.2.5 Sweden	12
1.2.6 Finland.....	16
1.2.7 Australia	17
1.3 OUTLINE OF CHAPTERS	22
CHAPTER 2 REACTIVE POWER AS AN ANCILLARY SERVICE.....	24
2.1 INTRODUCTION.....	24
2.2 SYNCHRONOUS GENERATORS AS REACTIVE POWER SERVICE PROVIDERS	27
2.3 PROPOSED STRUCTURE OF THE REACTIVE POWER MARKET	29
2.3.1 Cost of Reactive Power Production	30
2.3.2 Structure of Reactive Power Offers from Generators.....	31
2.4 OPTIMAL PROCUREMENT OF REACTIVE POWER SERVICES.....	34
2.4.1 Marginal Benefit from a Reactive Power Service	35
2.4.2 Optimal Reactive Power Procurement.....	38

2.5 SIMULATIONS ON CIGRÉ 32-BUS SYSTEM: RESULTS AND DISCUSSIONS	39
2.5.1 Step-I: Obtain Marginal Benefit from Reactive Power Support at a Bus	40
2.5.2 Step-II: Final Optimization	41
2.5.3 Uncertainty in Reactive Power Demand and Offer Prices...	42
2.6 CONCLUDING REMARKS.....	45

CHAPTER 3 TOWARD A COMPETITIVE MARKET FOR REACTIVE POWER
..... **47**

3.1 MARKET SETTLEMENT AND PRICE FORMATION	48
3.1.1 Market Settlement to Minimize Payment	49
3.1.2 Market Settlement to Minimize Transmission Losses	51
3.1.3 Market Settlement to Minimize Deviation from Contracted Transactions.....	52
3.1.4 Market Settlement to Minimize the Compromise Function	52
3.2 CASE STUDY AND SCENARIO ANALYSES.....	54
3.2.1 Simulation Results and Discussions.....	55
3.2.2 A Note on Computational Aspects.....	61
3.3 CONCLUDING REMARKS.....	62

CHAPTER 4 LOCALIZED REACTIVE POWER MARKETS USING THE CONCEPT OF VOLTAGE CONTROL AREAS **64**

4.1 CREATING VOLTAGE CONTROL AREAS FROM A WHOLE SYSTEM ...	65
4.1.1 Electrical Distance.....	65
4.2 REACTIVE POWER MARKET FOR LOCAL VOLTAGE CONTROL AREAS	67
4.3 CASE STUDY WITH CIGRÉ 32 BUS SYSTEM	69
4.3.1 Case-0: System as Whole.....	73
4.3.2 Case-1: Considering Voltage Control Areas.....	74

4.3.3 Case-2 and Case-3: Gaming by Generator 4072.....	76
4.4 CONCLUDING REMARKS.....	78

CHAPTER 5 DESIGN OF COMPETITIVE MARKETS FOR SPINNING RESERVE SERVICES 79

5.1 SPINNING RESERVE SERVICES.....	79
5.2 DESIGN OF A SPINNING RESERVE SERVICE MARKET THAT IS INDEPENDENT OF THE ENERGY MARKET	81
5.3 SPINNING RESERVE SERVICE PROCUREMENT AND MARKET SETTLEMENT	83
5.3.1 Structure of Spinning Reserve Service Offers	83
5.3.2 Model Description.....	85
5.4 CASE STUDY AND SCENARIO ANALYSES.....	86
5.4.1 Perfect Competition.....	87
5.4.2 Imperfect Competition	89
5.4.3 Spinning Reserve Market Price versus Available Capacity Relationship.....	92
5.5 CONCLUDING REMARKS.....	94

CHAPTER 6 FREQUENCY REGULATION AS AN ANCILLARY SERVICE..... 95

6.1 INTRODUCTION.....	95
6.2 DESIGN OF A FREQUENCY REGULATION MARKET	98
6.2.1 Primary Regulation	99
6.2.2 Secondary Regulation	102
6.3 CASE STUDY	104
6.3.1 Primary Regulation	106
6.3.2 Secondary Regulation	106
6.3.3 System Performance with Primary and Secondary Regulation Services	108
6.4 CONCLUDING REMARKS.....	110

CHAPTER 7 CONCLUSIONS.....	112
7.1 MAIN CONCLUSIONS AND CONTRIBUTIONS.....	112
7.2 SCOPE FOR FUTURE WORK.....	113
REFERENCES	114
APPENDICES	119
APPENDIX-A CIGRÉ 32-BUS SYSTEM	119
APPENDIX-B MODELING BILATERAL CONTRACTS	122

CHAPTER 1

INTRODUCTION*

1.1 POWER INDUSTRY DEREGULATION AND EMERGENCE OF ANCILLARY SERVICES

The electric power industry has over the years been dominated by large utilities that had an overall authority over all activities in generation, transmission and distribution of power within its domain of operation. Such utilities have been referred to as *vertically integrated utilities*, and these served as the only electricity supplier in the region and were obliged to provide electricity to everyone.

Since the past decade, power utilities worldwide have been going through a process of reforms in order to introduce commercial incentives in generation, transmission and distribution. The main objectives of the reforms are achieved through a clear separation between production and sale of electricity, and network operations. The erstwhile vertically integrated generation, transmission and distribution system operations have been separated into independent activities. The generation companies and power stations sell energy through competitive long-term contracts with customers or by bidding for short-term energy supply at the spot market [1], [2].

Transmission is still a monopoly since the economics of scale are very high. Transmission open access has proved to be an important requirement in deregulated systems. To guarantee a level playing field for the generators and customers to access the transmission network, the transmission system operator is required to be independent from other market participants.

The Independent System Operator (ISO) has acquired a central coordination role and carries out the important responsibility of providing for system reliability and security. It manages system operations, such as

* Some parts of this chapter has been published as the following paper:

- J. Zhong and K. Bhattacharya, "Reactive power management in deregulated electricity markets – A review," Proceedings of IEEE Power Engineering Society Winter Meeting, New York, January 2002, pp.1287-1292.

scheduling and operating the transmission-related services. The ISO also has to ensure a required degree of quality and safety, provide corrective measures when faced with incidents, and several other functions. In addition, the ISO could also manage market administration, energy auction and unit commitment functions in the pool market structure.

To this effect, certain services, such as, scheduling and dispatch, frequency regulation, voltage control, generation reserves, *etc.* are required by the power system, apart from the basic energy and power delivery services. Such services, which are now commonly referred to as *ancillary services*, had all along been part of the normal electricity supply and were not separated in the traditional vertically integrated power systems. Ancillary services are also referred to as Interconnected Operation Services by the North American Electric Reliability Council (NERC).

However, in deregulated power systems, transmission networks are available for third-party access to allow power wheeling, and spot markets for electricity have developed in many countries. In such a deregulated environment, the ancillary services are no longer treated as integral to the electricity supply. They are unbundled and priced separately, and system operators have to purchase ancillary services from ancillary service providers.

Issues pertaining to costing of ancillary services and hence appropriate pricing mechanisms for all market participants to recover the costs become an important issue for proper functioning of the system.

1.1.1 Ancillary Services as seen by Customers, Power Producers and the Operators

For the customer, ancillary services are integrated to its electricity supply and are thus not separately distinguishable. Any customer connected to the network is implicitly a consumer of ancillary services through continuity of the supply and the quality of supply it is receiving. This is true for any category of customer.

For power producers, whether they are vertically integrated utilities or independent power producers, ancillary services are mainly defined by the basic contributions they make to fulfill the system functions. Besides the supply of active power, they supply or absorb reactive power and control the voltage as well as contribute to maintaining the system frequency. In

addition, there are other services to improve the system operation, such as follow-up of daily load, supply of reliable forecast information particularly on availability, contribution to restoring voltage following an incident and therefore the capacity to trip house load, *etc.*

Finally, the power system operator ensures the link between the power producers and customers. It collects the basic contributions of power producers, incorporates them into the economic management of the system while adding its own contribution and provides carefully worked out services to assure continuous supply to customers. All this calls for resources and implies costs. It therefore raises the problem of evaluating the cost for the system, compensation of service suppliers and the allocation of costs to service customers.

1.1.2 Ancillary Services' Classifications and Definitions

Ancillary services are those services provided by the equipment in the system and generators that generate, control, and transmit electricity in support of the basic services of generating capacity, energy supply, and power delivery. These services are necessary to support the transmission of power while maintaining system reliability and ensuring the required degree of quality and safety.

In this section, we discuss the NERC definitions of ten ancillary services [3].

Category-1: Services required for routine operation

- **System Control**
The control area operator functions that schedule generation and transactions and control generation in real-time to maintain generation/load balance.
- **Voltage Control**
The injection or absorption of reactive power from generators or capacitors to maintain system voltages within required ranges.
- **Regulation**
The use of generation or load to maintain minute-to-minute generation/load balance within the control area.
- **Load Following/Energy Imbalance**
The use of generation to meet the hour-to-hour and daily variations in load.

Category-2: Services needed to prevent an outage from becoming a catastrophe

- Spinning Reserves
The provision of unloaded generating capacity that is synchronized to the grid and can immediately respond to correct for generation/load imbalances, caused by generation and/or transmission outages, and that is fully available within several minutes.
- Supplemental Reserves
The provision of generating capacity and curtailable load to correct for generation/load imbalances, caused by generation and/or transmission outages, and that is fully available within several minutes. However, unlike spinning reserves, supplemental reserve is not required to respond immediately.
- Network Stability Services
Maintenance and use of special equipment (power-system stabilizers and dynamic-braking resistors) to maintain a secure transmission system.

In addition to these three services, voltage control service falling in Category-1 can also act like Category-2 services and prevent voltages from decaying so far that voltage collapse occurs, and system control is required to manage these services.

Category-3: Services needed to restore the system after a blackout

- System Blackstart Capability
The ability of a generating unit to proceed from a shutdown condition to an operating condition without assistance from the electrical grid and then to energize the grid to help other units start after a blackout occurs.

System blackstart, along with several of the services discussed above (system control, voltage control, network stability, contingency reserves, regulation, and load following), is required to rebuild the electrical grid after system blackouts.

1.1.3 Scope of this Work

The work presented in this thesis examines in detail the functioning of three particular services from amongst the ten services defined by NERC and discussed in the previous sub-section. These are as follows:

- Reactive power service provided by generators
- Spinning reserve service
- Frequency regulation service

In all the cases, the work attempts to develop an integrated market design for the said service that is fair and competitive and can be applicable to the ISO as a procurement tool for the services. In the following sub-sections, we shall discuss some of the aspects of how these ancillary services are organized and managed by the system operators in different deregulated markets around the world.

1.2 GLOBAL OVERVIEW OF ANCILLARY SERVICE

MANAGEMENT

1.2.1 New York ISO

In the New York control area, ancillary services are provided by the New York ISO (NYISO) or procured by the transmission customers and suppliers themselves. The NYISO coordinates the provision of all ancillary services and directly arranges for those services that are not self-supplied. Due to the nature of the services, either market-based or embedded cost-based prices are used to price these services. In Table 1.1, the service provider and pricing method for each service are given.

Table 1.1 NYISO ancillary services details

Ancillary Service	Who provides the service? NYISO, or Self-Supplied (SS)	What is the pricing method for the Ancillary Service?
Scheduling, System Control and Dispatch	NYISO	Embedded Cost Based
Voltage Support	NYISO	Embedded Cost Based
Regulation and Frequency Response	NYISO or SS	Market-based
Energy Imbalance	NYISO	Market-based
Operating Reserve	NYISO or SS	Market-based
Black Start Capability	NYISO	Embedded Cost Based

Transmission customers and suppliers are permitted to self-supply operating reserve service, regulation and frequency response service. They

must bid the required resource into ancillary services market. The NYISO selects the successful bidders to provide each service [4].

1.2.1.1 Reactive Power Service

The NYISO is responsible for providing reactive power support services, and this is provided at embedded cost-based prices. Generating resources, which operate within their capability limits, are directed by NYISO to produce / absorb reactive power to maintain voltages within their limits. The pricing method for the reactive power support service is an embedded cost based price [4].

The cost of reactive power support includes the following:

- The total annual embedded cost for payment
- Any applicable lost opportunity cost to provide reactive power service
- Total of prior year payments to suppliers of reactive power service less the total of payments received by the NYISO from transmission customers in the prior year for reactive power service.

Lost Opportunity Cost

If the NYISO dispatches or directs a generator to reduce its real power output in order to allow the unit to produce or absorb more reactive power, the generator may receive a component of payment accounting for the Lost Opportunity Cost (LOC). The method for calculating the LOC is based on the following factors:

- Real time long-term based marginal price (LBMP)
- Original real power dispatch and the new dispatch point
- Bid curve of generator supplying reactive power service

Figure 1.1 describes the calculation of the lost opportunity cost for a generator, which decreases its real power output to provide more reactive power service. In Figure 1.1, P_{RT} is the Long-term Based Marginal Price (LBMP), and $f(P)$ is the bid curve of the generator supplying reactive power support. D_1 and D_2 are the original and new dispatch points respectively while B_1 and B_2 are the corresponding bid prices at D_1 and D_2 .

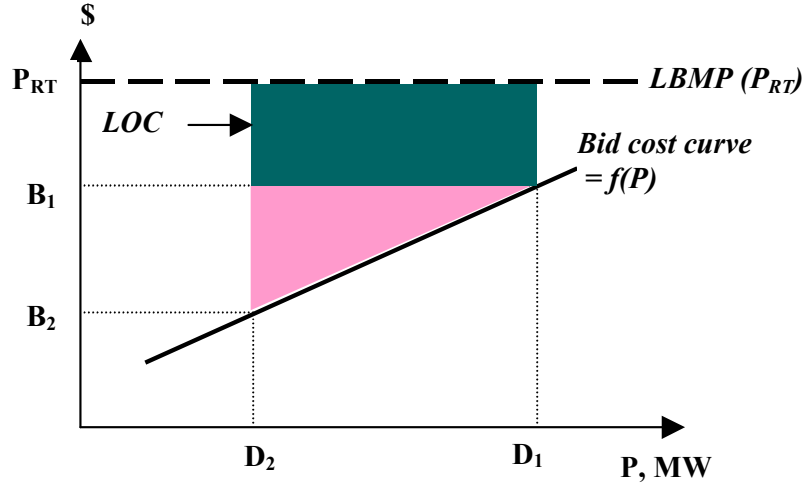

Figure 1.1. Method for calculating Lost Opportunity Cost by NYISO

As the real power output is decreased, the generator receives lesser revenue from the sell of energy although by way of this reduced generation, it saves some generating cost. The reduced income for the generator (ΔR) can be described by equation (1.1).

$$\begin{aligned} \Delta R &= \text{Revenue loss} - \text{Savings from reduced generating cost} \\ &= P_{RT}(D_1 - D_2) - \int_{D_2}^{D_1} f(P) \cdot dP \end{aligned} \quad (1.1)$$

The first term in (1.1) denotes the revenue lost by the generator while backing down its real power output from D_1 to D_2 , and the second term denotes the corresponding reduction in generation cost. Note that, ΔR also equals the savings to the ISO. The saving of the generator (ΔS) from reduced real power output is described in equation (1.2),

$$\Delta S = B_1(D_1 - D_2) - \int_{D_2}^{D_1} f(P) \cdot dP \quad (1.2)$$

The LOC of the generator equals to the difference between ΔR and ΔS ;

$$LOC = (P_{RT} - B_1) \times (D_1 - D_2) \quad (1.3)$$

1.2.1.2 Regulation and Frequency Response Service of New York ISO

The NYISO offers regulation and frequency response services within the New York (NY) control area. Regulation and frequency response services are necessary for the continuous balancing of generation with load and NY

control area interchange, and to assist in maintaining frequency at 60 Hz. This service is accomplished by committing on-line generators, predominately through the use of automatic generation control, to follow moment-to-moment changes in load.

Regulation service is bid into the market by individual units that have AGC capability and that wish to participate in the regulation market. Bid information includes regulation response rate (MW/min) and regulation availability rate (\$/MW). The NYISO selects regulation service in the day-ahead market from all bidders.

The bids submitted by suppliers are stacked from the lowest priced offer to the highest priced, taking into account the operational requirements for up and down regulation. The NYISO selects the bids starting with the lowest bid, and the last selected bid is set as market clearing price. All suppliers selected in the market receive an *availability payment* calculated with the corresponding market clearing price.

The NYISO has a Performance Tracking System to monitor the performance of generators that provide regulation service. Payments by the NYISO to each supplier of this service are based in part on the generator's performance with respect to expectations.

The NYISO makes the following settlement with suppliers of regulation service:

- An hourly availability payment for reserving capability to provide regulation service
- An energy payment based on the amount of regulation provided
- A financial penalty based on poor performance as measured against expectations

1.2.2 California ISO

In the California system, the ISO procures reactive power support services on long-term contracts from reliable must-run generating units [5]. The actual short-term requirement is determined on a day-ahead basis, after the real power market is settled and the energy demand and schedules are known. Thereafter the ISO determines the location-wise amount of reactive power required based on system power flow analysis. Daily voltage schedules are issued to contracted generators and the transmission operators within the region.

The generators are mandated to provide reactive power within the power factor range of 0.90 lag to 0.95 lead (Figure 1.2). For reactive power absorption / generation beyond these limits, the generators are financially compensated for, including, a payment if they are required to reduce their real power output.

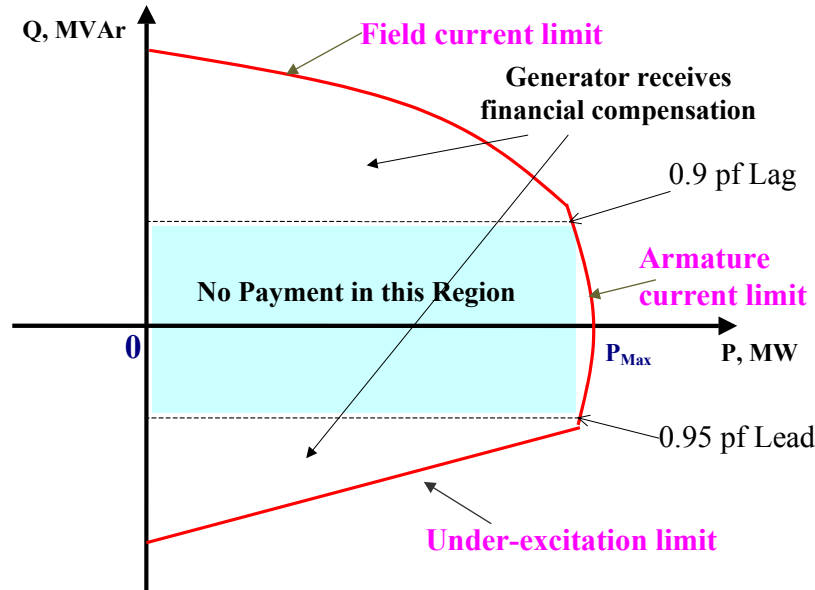

Figure 1.2. The mandatory (no payment) reactive power requirement and the ancillary service component that receives financial compensation in the California system

1.2.3 PJM Interconnection

The Pennsylvania - New Jersey - Maryland (PJM) inter-connection restructured its operations in 1997 and PJM was established as the ISO. As per the report of the Market Monitoring Unit [6] and [7], reactive power was recognized as an ancillary service by PJM and two distinct components were segregated. The first component was the reactive capability at rated capacity of a generator while the second was the reactive capability at reduced generator output levels.

It has been mandated that reactive power supply and voltage control services will be provided directly by the individual transmission providers. The transmission providers in turn have defined the tariff rates for their customers, in this case, load serving entities either within the zone or outside. For the first component, *i.e.*, the reactive capability at rated capacity, the customer pays a charge proportional to the total generation owner's monthly revenue requirement and the amount of monthly use of the network.

Regarding the second component, generators are paid for their opportunity costs incurred as a result of increasing their reactive power production by reducing real power output. This is paid only to those generators that are directed to operate in such a mode and the opportunity cost is equal to the locational marginal price less the generator's bid for each MW that they back down.

1.2.4 United Kingdom

In the UK system, National Grid Company (NGC) carries out the role of the ISO and hence is also responsible for making arrangements with regards to ancillary services. It operates the transmission system with the objective of providing a reliable supply and maintaining voltage and frequency within the standards specified.

Therefore NGC contracts for ancillary services to enable voltage and frequency control standards to be maintained, as well as other services such as the black start capability. Generators, regional electricity companies, large consumers or even external members can supply these services. One of the key tasks of the *ancillary services business* is to encourage competition in the provision of ancillary services. The Grid Code details the technical operational requirements of NGC and defines two major categories of ancillary services, system ancillary services and commercial ancillary services. These are briefly described below [8].

System Ancillary Services

These services are fundamental to the satisfactory operation of the system and all generating units connected to either the NGC transmission system or a supplier's distribution system in England and Wales must be able to provide this. System ancillary services are classified in two categories.

Part-1: Those services, which all generators are obliged to provide

- *Reactive Energy*: Other than that supplied by means of synchronous or static voltage compensators.
- *Operating Margin (for frequency control)*: Capability to provide additional output from a generating unit with a short notice.

Part-2: Services that need not be provided at every site. NGC buys these services from sites based on specific contracts

- *Operating Margin (for frequency control)*: Capability of a gas turbine or pumped storage unit to fast start
- *Black Start Capabilities*

Commercial Ancillary Services

The other services are called the commercial ancillary services, which the generators are not obliged to provide and hence are subject to commercial agreements. Such services are as under:

- Reactive energy: supplied by synchronous or static voltage compensators
- Operating margin: provided by pumped storage units, load reduction, stand-by generation, *etc.*

1.2.4.1 Reactive Power Service

The Grid Code places a minimum obligation on all generating units, with a power generating capacity more than 50 MW, to provide a basic (mandatory) reactive power service. In order to receive payment for this service, the generators must enter into a *Default Payment Mechanism (DPM)*. Alternately, the generators can offer the mandatory reactive power service through the tender market by structuring their bids to reflect the value that they perceive their service is worth. This way of meeting the mandatory Grid Code with a market mechanism is termed as *Obligatory Reactive Power Service (ORPS)*. The income a generator could receive by providing reactive power varies according to the number of generators who can provide that service within a zone and the relative need [9]. Further, generators with reactive power capability in excess of the Grid Code can offer an *Enhanced Reactive Power Service (ERPS)*.

The Default Payment Mechanism was initially (in 1997/98 when the scheme was started) based on two components -- a capability payment component and an actual utilization based payment component with a ratio of 80:20. This ratio underwent a staircase phasing of the capability component and since April 2000, the ratio has been 0:100 and Default Payment Mechanism is based on metered reactive utilization only (Figure 1.3).

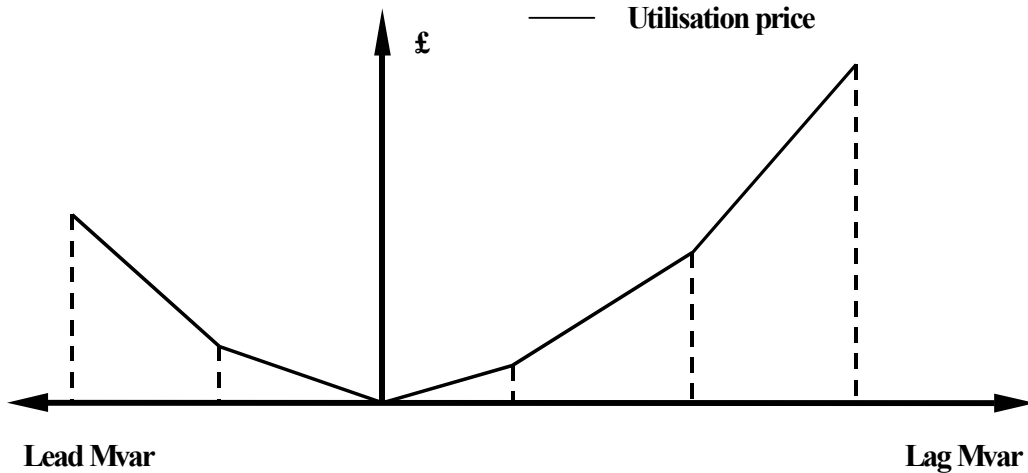

Figure 1.3. Tender bid price structure for reactive power utilisation

1.2.5 Sweden

The Swedish electricity market is dominated by bilateral contracts between suppliers and customers although share of energy being traded in the spot market is increasing. The bilaterally contracted transactions are usually on a long-term basis and generally finalized months ahead. Once these transactions are finalized, and the daily spot-market trading is settled, the suppliers and customers send information of these trades and generation schedules to Svenska Kraftnät who is thereafter responsible for safe system operation. Svenska Kraftnät, the ISO, procures and provides the ancillary services required, in order to satisfy the system operation requirements. With regard to ancillary service, both reserve and regulation services are acquired by Svenska Kraftnät through the regulating markets. Svenska Kraftnät additionally pays balancing entities for governor response and load matching on fixed contracts.

Svenska Kraftnät is also responsible for the short term planning of the Swedish transmission system operation with regard to voltage quality, continuity of service and coordination of the national balance between generation and consumption, accounting for the electricity imports and exports.

In order to maintain the electricity demand supply balance on a minute-by-minute basis, a two-tier approach is adopted. The primary regulation is based on automatic frequency control on generators in suitable power stations. Svenska Kraftnät purchases long-term contracts from generating companies for such primary regulation. The secondary regulation is carried

out by activating the most favorable bids (for quantity and price) from generators willing to increase or decrease their generation; or even consumers willing to increase or decrease their consumption.

At the end of each hour, the costs are distributed based on the individual players' unbalance data and the type of regulation (up or down regulation) called for by the system operator. The hourly regulating price is fixed as the price for the most expensive measure (regulating up- balance service purchases) or least expensive measures (regulating down- balance service sells) utilized during the hour.

Presently no compensation is paid to generators for reactive power. Load shedding is recognized as an ancillary service, but not compensated. No other ancillary services are recognized.

1.2.5.1 Reactive Power Management

The Swedish electricity system is characterized by bulk power flows from the north, where a major share of generation is located, to the south, where most of the load centers are, over long distance transmission lines. As reactive power cannot be transmitted over such distances, it should be provided by local sources. Svenska Kraftnät owns the national grid (400 kV and 220 kV), and also carries out the responsibilities of the ISO while the regional and local network companies operate the sub-transmission and distribution networks (130 kV and less) [10].

Reactive power services are provided on a mandatory basis in Sweden although various schemes for financial compensation to the providers of this service are being considered. The reactive power exchange on the national grid is controlled by instructions from Svenska Kraftnät. It is recommended that reactive power flow between different parts of the grid be kept 'near zero'. The ISO has the right to the supply of reactive power from spinning generators directly connected to the national grid.

The regional network companies are responsible for voltage control in their respective areas. Under normal conditions the regional network operators use as much static reactive power production as possible. Large generators are rarely used for secondary voltage control and are reserved for serious situations. Such units operate at a constant reactive power output, with a stable operating point considering vibration and losses.

Formal Agreements for Reactive Power Transfer over the Grid

For power transactions over the network, Svenska Kraftnät enters into formal agreements for reactive power exchange with independent generators and regional networks. Agreement for feeding power into the national grid is mostly with producers but in certain cases, can also be with regional networks. Following are some of the standard set of agreements:

- A hydro unit connected directly to the national grid is required (*mandatory*) to be able to inject as well as absorb reactive power as per the following limits.

$$\text{Reactive Injection} = \frac{1}{3} P_{Max}$$

$$\text{Reactive Absorption} = \frac{1}{6} P_{Max}$$

- A thermal unit connected directly to the national grid is required (*mandatory*) to maintain capability of reactive power injection as per the limits, given below. However, it has no requirement on absorption of reactive power.

$$\text{Reactive Injection} = \frac{1}{3} P_{Max}$$

- A regional network with agreement to inject real power into the national grid is required to maintain a capability to inject reactive power, depending on the instantaneous real power injection, as given below.

$$\text{Reactive Injection} = \frac{1}{3} P_{instantaneous}$$

There is no requirement on absorption of reactive power from the national grid. Also there is no specific requirement from a generator connected to the regional grid.

- A regional network with agreement for drawing real power from the national grid, there is no requirement for injection or absorption of reactive power to/from the national grid.

1.2.5.2 Conventions and Practices for Frequency Control

The nominal frequency in the Nordic system is 50 Hz and it is stipulated that fluctuations during normal system operations should not exceed 0.1 Hz. The

nuclear units are set to trip below a frequency of 47.5 Hz, hence the frequency should, under no circumstances, go below this. This situation could be alleviated by load curtailment schemes. At frequencies higher than 51 Hz, the thermal units are set to reduce their outputs automatically.

Primary Frequency Control

The primary frequency control has the responsibility to cover unbalances due to spontaneous load variations and mismatches between planned generation and actual load level. The total primary frequency reserves in Sweden have to meet the following requirements:

Total reserve margin at 50 Hz: 240 MW

Total gain, at least: 2400 MW/Hz.

Each country in the Nordic system is responsible for a part of the total margin and gain determined for the Nordic system in relation to the annual energy consumption of the system. Technically, the capacity margin required for primary frequency control is provided by hydro units. The various operator actions that are initiated when frequency in the Nordel system deviates from its nominal value are shown in Figure 1.4 [11].

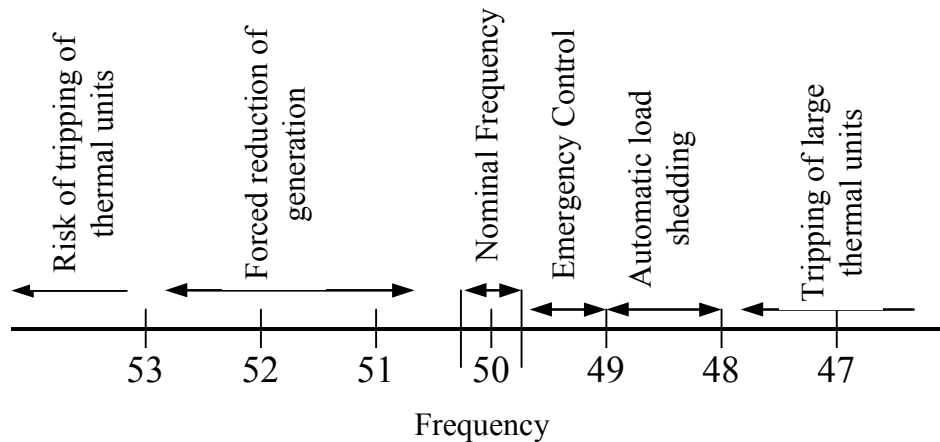

Figure 1.4. Frequency range and operator action in the Nordel system

Balance Services for Secondary Frequency Control

Svenska Kraftnät operates a balance service, which is used for secondary regulation, to continuously balance the country's electricity generation and consumption. It accepts bids -volume (power in MW) and price (SEK/MWh) from generators willing to quickly (max 10 minutes) increase or decrease generation, or even consumers willing to increase or decrease consumption. The bids for regulation are arranged in price order to form a "staircase" for

each operating hour (Figure 1.5). When regulation is needed, the system operator activates the most profitable bid for regulating up or down.

At the end of each hour, the regulation price is determined in accordance with the most expensive measure taken during upward regulation (the purchase of balance energy), or the cheapest measure taken during downward regulation (the sell of balance energy), used during the hour as in Figure 1.5. The final regulation price applies to all those selected to regulate the balance upwards or downwards.

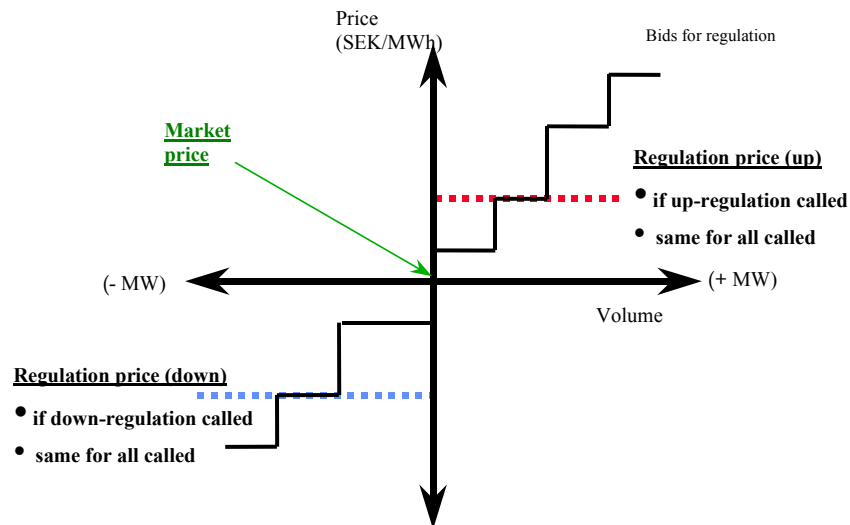

Figure 1.5 Balance Regulation Bids

1.2.6 Finland

The Finnish ISO, Fingrid is responsible for maintenance of system voltages and accordingly, it supplies reactive power as per the general supply principles concerning reactive power. The voltage level of the main grid is controlled using reactors and capacitors. The voltage ratio between different voltage steps is controlled with tap changers of the transformers.

Fingrid is also responsible for the maintenance of adequate reactive power reserves in the Finnish power system. This is done through the use of its own resources and also by acquiring reactive reserves from independent parties [12]. This provision for reactive power reserves is a mandatory service as of now. It is likely that a tariff mechanism for financial compensation will be in place for this service in the near future.

As per the guidelines, generators of more than 10 MVA rating are required to maintain reactive power reserves during the normal status of the power system:

- For generators connected to the 400 kV grid, the entire reactive capacity should be available as momentary reserves and mandatory, with the exception of that amount consumed by transformers and the plant itself.
- For generators connected to 220 kV and 110 kV grid, the mandatory momentary reactive power reserve should not be less than half of the calculated reactive capacity corresponding to a power factor of 0.9. The rest can be used as a commercial service.
- For generators connected to the grid at voltage levels less than 110 kV, half of the reactive power intake capacity at the generator's voltage level, is also required to be reserved as momentary disturbance reserve and mandatory.

1.2.7 Australia

In Australia the National Electricity Market Management Company (NEMMCO) is the ISO, and hence responsible for system security, procurement and scheduling of various ancillary services. Seven services are recognized for procurement and compensation and these are categorized in five system control activities as follows [13]:

- Frequency control services
 - Automatic generation control: This service is required from a generator within five minutes of the ISO request.
 - Governor control: This service is based on the generator's governor droop characteristic and aids in frequency control, acting in a 1 second to 1 minute time frame.
 - Rapid generator unit loading: This service requires generators not in operation to synchronize with the system within a five minutes time frame.
 - Load shedding: This service requires curtailment of load following extreme frequency variations. The loads are expected to automatically respond and disconnect within a one-minute time frame.
- Voltage control services

- Reactive power: This service is provided to keep system voltages at desired levels by injection or absorption of reactive power at different nodes in the system. The financial compensation in this scheme is provided only to generators and synchronous compensators.
- Stability control services
 - Rapid generator unit unloading: This requires a generator to unload rapidly from its normal operating condition in order to preserve system stability. This may be required under certain circumstances and is recognized as a system stability service.
- Network loading control services
 - Automatic generation control
 - Load shedding

These have been discussed above in the context of frequency control services. These two services are also recognized as network loading control services.
- System restart services
 - System restart is similar to the black start capability service discussed in the context of NERC. This requires that the generator is able to supply the transmission system following a complete system failure.

Payment Mechanisms

The payments to the ancillary service providers have been organized in the Australian market based on the type of service provided and the providers' costs, including opportunity costs if any. Four categories of payment mechanisms are recognized and a particular service may call for one or more of the components for compensation.

- Availability payment: This is made to those services that require the provider's preparedness for providing the services when called for. This payment is applicable to system restart services and reactive power services from generating units.
- Enabling payment: This payment is made if a concerned service has been enabled (or activated) by the ISO for use. This applies to all the ancillary services except for system restart and reactive power from generators, although reactive power service from synchronous compensators is eligible for this payment.

- Usage payment: This payment is based on actual use of the concerned ancillary service by the ISO and applies only to the rapid loading and rapid unloading services provided by generating units.
- Compensation payment: This payment is based on the provider's opportunity costs and is paid when the concerned provider has been constrained from operating according to its market decisions. This payment is applicable to all categories of services except reactive support service from synchronous compensators and system restart services.

1.2.7.2 Reactive Power Service

All reactive power ancillary service providers are eligible for the *availability payment component* - for their preparedness in providing the service when called for. Further, the synchronous compensators also receive an *enabling payment component* - when their service is activated by the ISO for use. On the other hand, a synchronous generator receives the *compensation payment component* - based on its opportunity cost, and paid when it has been constrained from operating according to its market decisions. The total payment for reactive power service is shown in Figure 1.6.

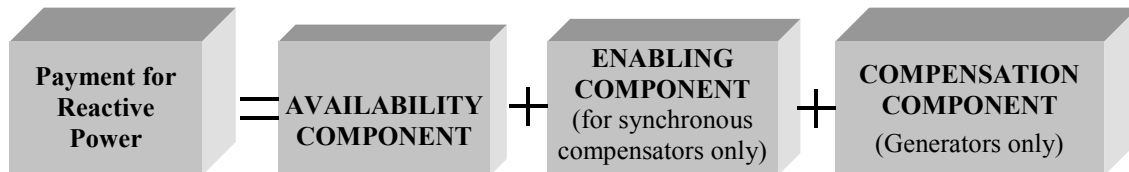

Figure 1.6. Payment for Reactive Power

The provision for reactive power from generators is separated in two categories:

- The mandatory reactive power support, and
- Reactive power as an ancillary service

As explained in Figure 1.7, it is mandatory for the generators to provide reactive power within the operating power factors of 0.9 lagging and 0.93 leading. Beyond this mandatory component, is the ancillary service component, which is left to the generators to offer. However, there is a portion beyond the ancillary service component, which is left undefined [14].

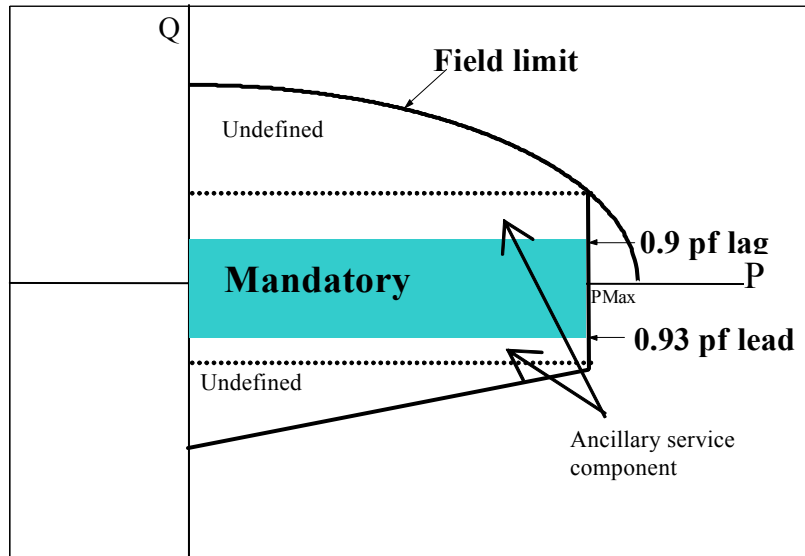

Figure 1.7. Generator Reactive Power Definitions in the Australian Market

1.2.7.3 Frequency Control Ancillary Service

Frequency control ancillary services provided by NEMMCO are concerned with balancing the supply and demand over short time intervals, and are separated into:

- a. small frequency deviation capability
- b. large frequency deviation capability

The small deviation service is used to keep the system frequency stable around 50 Hz under normal operating conditions, while the large frequency deviation service is used to recover the system frequency following larger disturbances [15]. Small frequency deviations could arise from demand variations, demand forecast error and non-conforming scheduled participants. The causes for large deviations can be generation / demand changes (planned and unplanned), and network contingencies that isolate generators.

The quantity of frequency control ancillary service requirement in various categories, together with the efficiency of providing it, will determine its ultimate cost. It depends on the potential size of the frequency deviations from credible contingencies and speed of response.

To meet the frequency control ancillary service requirement, governor control, automatic generation control and demand management options are used. For large deviations, network outage management, load shedding and

rapid generator response options are used in addition to the above options (Figure 1.8) [16].

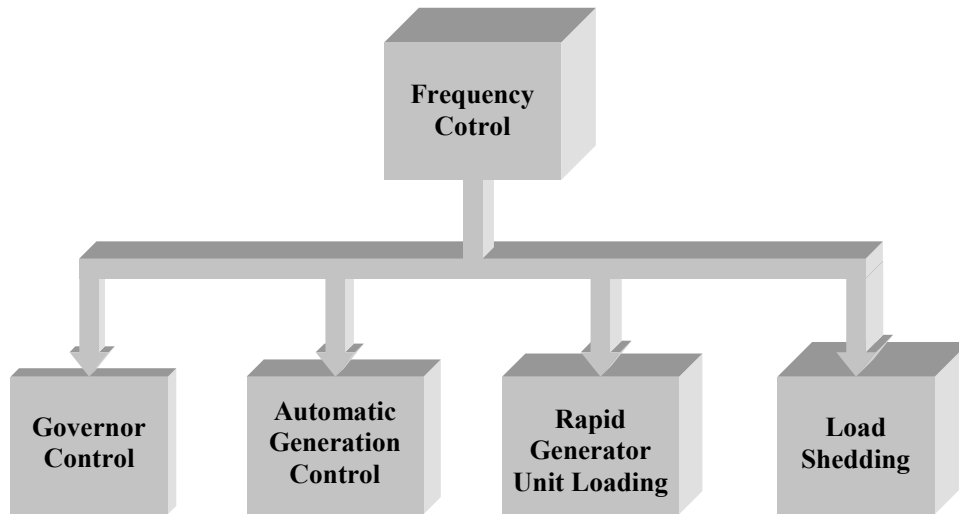

Figure 1.8 Framework of Frequency Control

Governor Control

The inherent ability of a generating unit's governor to correct the system frequency within a six to sixty second time frame.

Automatic Generation Control

The ability of a generating unit to respond to signals from the system operator in order to correct the system frequency within five-minute targets and prevent overloading of network elements.

Rapid Generator Unit Loading

The ability of a generator to deliver energy to the system from stand still in order to correct the system frequency within a five-minute time frame.

Load Shedding

The ability to automatically disconnect load in response to an extreme frequency deviation within a six to sixty second time frame, to correct frequency or to prevent overloading of network elements.

NEMMCO procures the frequency control ancillary service requirement and financial compensation to contracted parties are made based on the following three components:

- Enabling Component: a payment based on the quantity of capability made ready for use by the contracted providers in the dispatch process.
- Usage Component: a payment for some services (specifically load shedding) based on the actual use of the service – such payment does not apply to governors providing the instantaneous control.
- Compensation Component: compensation based on the assessed opportunity costs of backing off energy-producing units from their position in the energy market to provide the service.

1.3 OUTLINE OF CHAPTERS

Chapter-2 discusses the various issues involved in considering reactive power as an ancillary service. We examine the reactive power costing issues for supply of reactive power from synchronous generators. Subsequently, a bidding structure for reactive power has been proposed that take into account the costing issues. A method is developed to obtain the optimal contracts based on the ISO's objective of maximizing the social welfare.

In Chapter-3, a competitive market for reactive power services has been designed. Four components of uniform market prices for reactive power are obtained through a compromise programming based market settlement model. Different scenarios for simultaneous and individual gamings have been constructed to examine the extent of market power prevailing in the reactive power market.

In Chapter-4, the reactive power market is considered to be separated into voltage control areas, and uniform prices are obtained for individual voltage control areas. Analysis has been carried out to examine whether such a market is more desirable than a common system-wide reactive power market.

In Chapter-5, a spinning reserve service market is designed. A bidding structure for spinning reserve has been proposed and a market-clearing price

for the service is obtained by minimizing the payment. Analysis has been carried out to examine how ISO's procurements are affected by market imperfection.

In Chapter-6, a price-based frequency regulation service has been proposed, where an optimization framework is developed to obtain the market clearing prices for both primary and secondary regulation services. Thereafter, a dynamic simulation model demonstrates the effectiveness of the price-based frequency regulation services.

Chapter-7 draws the important conclusions from this thesis and discusses the future scope of work in ancillary service markets.

CHAPTER 2

REACTIVE POWER AS AN ANCILLARY SERVICE*

2.1 INTRODUCTION

The power transmission capability available from a transmission line design is limited by technological and economical constraints. Therefore, in order to maximize the amount of real power that can be transferred over a network, reactive-power flows must be minimized. Consequently, sufficient reactive power should be provided locally in the system to keep the bus voltages within nominal ranges in order to satisfy customers' equipment voltage ratings.

The reactive devices have different characteristics in terms of dynamics and speed of response, ability of voltage changes, capital costs, operating costs, and opportunity costs. For example, synchronous generators are very fast reactive support devices, but have high opportunity costs if real-power output has to be reduced to produce more reactive power. Opportunity cost of reactive power is the benefit or profit that could otherwise be harnessed, but is given up by the reactive power supplier in order to generate reactive power. On the other hand, capacitors are slow and have poor performance

* Some parts of this chapter has been published in the following papers:

- K. Bhattacharya and J. Zhong, "Reactive power as an ancillary service", *IEEE Transactions on Power Systems*, Vol.16, No.2 May 2001, pp. 294-300.
- K. Bhattacharya and J. Zhong, "Closure to Discussion by Carson Taylor, on Reactive Power as an Ancillary Service", *IEEE Transactions on Power Systems*, Vol.17, No.2, May 2002, pp.523-524.
- J. Zhong and K. Bhattacharya, "Optimum Var support procurement for maintenance of contracted transactions," *Proceedings of International Conference on Electric Utility Deregulation, Restructuring and Power Technologies (DRPT2000)*, London, April 2000, pp. 636-641.
- J. Zhong, K. Bhattacharya and J. Daalder, "Reactive power as an ancillary service: Issues in optimal procurement", *Proceedings of IEEE-PES/CSEE International Conference on Power System Technology (POWERCON)*, Perth, Australia, December 2000, pp.885-890.

but are cheap to install and operate. The characteristics of different types of voltage-control equipment are given in Table 2.1 [17].

Table 2.1. Characteristics of different types of voltage control equipment

Equipment Type	Speed of Response	Ability to support voltage	Capital Cost (per kVAr)	Operating Cost	Opportunity Cost
Synchronous Generator	Fast	Excellent, additional short-term capacity	Difficult to separate	High	Yes
Synchronous Condenser	Fast	Excellent, additional short-term capacity	\$30-35	High	No
Capacitor	Slow, stepped	Poor, drops with V^2	\$8-10	Very low	No
Static VAR compensator	Fast	Poor, drops with V^2	\$45-50	Moderate	No

In vertically integrated electricity systems, reactive power support was part of the system operator's activities and the expenses incurred in providing for such services were included within the electricity tariff charged to customers.

In deregulated electricity markets, provision for reactive power support needs to be made by the ISO in order to meet the contracted transactions in a secure manner. Since it is not desirable to transport reactive power over the network, procurement of reactive power services should be done taking into account the perceived demand conditions, mix of the load and availability of reactive power resources. Most often, the independent generators or customers own the resources for reactive support such as synchronous generators, synchronous condensers, capacitor banks, reactors, static var compensators and FACTS devices, and the ISO needs to enter into contracts with them for such provision.

In the White Paper on Proposed Standards for Interconnected Operations Services of NERC [18], it has been notified that only generation sources shall be entitled to provide reactive power, as an ancillary service. The other entities providing reactive support shall not be eligible for any financial compensation. However, the operating authority coordinates the use of static reactive supply devices throughout the system. Also all synchronous generators are required to be operating with their excitation system in automatic voltage control mode so that the generators' reactive power outputs during emergency conditions do not fall short of the reactive capability. This is particularly useful when the generators are operating at points higher than rated real power wherein the armature current heating limits restrict the reactive power output.

As we have already discussed in Chapter-1, reactive power management and payment mechanisms vary for each deregulated electricity market. Usually the ISO enters into contracts with reactive power providers for their service provisions. In the US context, as per the NERC's Operating Policy-10 [19], only that reactive power provided by synchronous generators are considered ancillary services and can receive financial compensation for their services. This is also true for the UK and Australian markets. The Australian market additionally considers reactive power from synchronous condensers also as an ancillary service.

On the other hand, deregulated markets in the Nordic countries do not have any provision for payments towards reactive power services. For example, in Sweden the responsibility for managing reactive power lies with network companies, with certain rules from the ISO, stipulating that there should be no exchange of reactive power over different network voltage levels and transformers. To meet these requirements, individual entities, such as local and regional networks, have to make provision for their own reactive power [20].

In a similar manner in the Netherlands, the network companies have to take care of their reactive power requirement individually. These companies however purchase reactive power locally through bilateral contracts with generators or through exchanges with other network companies. Those generators that have been contracted for the reactive power service are paid for their reactive power capacity only. No payment is made for reactive energy.

Nevertheless, from the earlier discussions we see that there has been a move towards creating payment mechanisms for reactive power services in many systems. However, a fully competitive reactive power market has yet to emerge. Several issues make operating reactive power services within a competitive market framework very difficult. Some of them can be listed out as follows:

- Reactive power services are required to be provided locally, and hence the 'worth' of one MVAR of reactive power is not the same everywhere in the system. Consequently, if a reactive power market is settled like a real power market, the ISO can end up contracting a set of low-priced offers, from such locations (buses) that are undesirable from system considerations. Therefore, reactive power markets need a new approach that takes into account both offer prices and location of the resource.

- As we have noted in [21], none of the deregulated electricity networks yet recognize reactive power from sources other than generators or synchronous condensers as "ancillary services." Changes at the policy level are necessary to include other reactive power sources such as capacitors, reactors, SVCs and FACTS devices *etc.*, as ancillary services. This would enlarge the market and increase the competition, and inevitably increase the market efficiency and fairness. However, in this thesis we shall not consider such issues but only consider generators and synchronous condensers as reactive power ancillary service provider.
- A long-term contract based reactive power market could prevent providers from exercising their market power and offering their reactive energy at higher prices than the cost of alternative reactive power generation [22].

We can therefore summarize that reactive power needs to be introduced in the ancillary service markets in a fair and equitable manner. Providers of reactive power support should be compensated for their services. However there are several complex issues involved in handling a reactive power service and in creating an efficient market for reactive power. In this chapter, we shall examine the various issues involved in reactive power management, as an ancillary service.

2.2 SYNCHRONOUS GENERATORS AS REACTIVE POWER SERVICE PROVIDERS

While reactive power ancillary services may be provided by many different parties such as generators, transmission / distribution companies, or even large customers, the importance of synchronous generators in providing the service remains a critical issue.

In this section we examine the reactive power generation capability of a synchronous generator. The power output of a synchronous generator is usually limited to a value within the MVA rating by the capability of its prime mover. When real power and terminal voltage is fixed, its armature or field winding heating limits determine the reactive power generation from the generator. The armature heating limit is a circle (Refer to Figure 2.1) with radius $R_1=(V_t I_a)^{1/2}$ centred on the origin, given by equation (2.1), and the field heating limit is a circle, centred at $C_2, (0, -V_t^2/X_S)$ with radius $R_2=V_t E_{af}/X_S$, given by equation (2.2) [23]. V_t is the voltage at the generator

terminal bus, I_a is the steady-state armature current, E_{af} is the excitation voltage and X_s is the synchronous reactance. P and Q are real and reactive power generation from the machine, respectively.

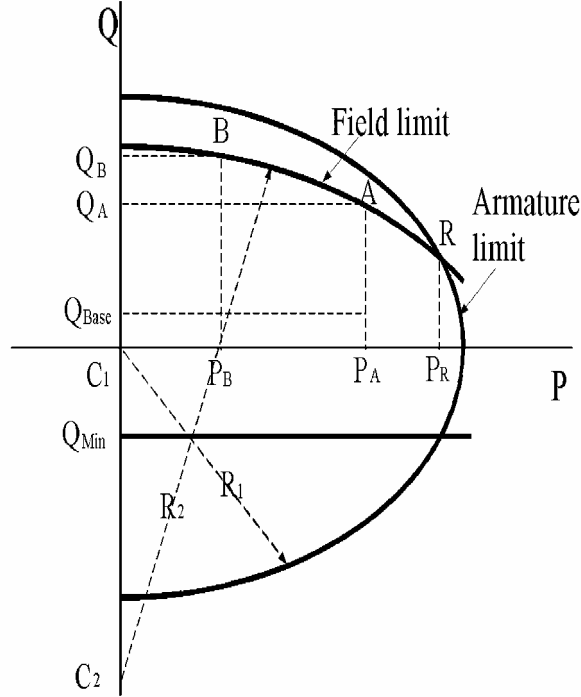

Figure 2.1. Synchronous Generator Capability Curve

$$P^2 + Q^2 \leq (V_t I_a)^2 \quad (2.1)$$

$$P^2 + \left(Q + \frac{V_t^2}{X_s} \right)^2 \leq \left(\frac{V_t E_{af}}{X_s} \right)^2 \quad (2.2)$$

The machine rating is the point of intersection of the two circles ('R' in Figure 2.1). When $P < P_R$, the limit on Q is imposed by the generator's field heating limit. While, when $P > P_R$ the armature heating limit imposes restrictions on Q . P_R is the real power corresponding to machine rating power.

To examine further into the generator's reactive power supply, let us consider Figure 2.2. In Figure 2.2, Q_{base} is the reactive power required by the generator for its auxiliary equipment. If the operating point lies inside the limiting curves, say at (P_A, Q_{base}) , then the unit can increase its reactive generation from Q_{base} up to Q_A without requiring re-adjustment of P_A . This will however, result in increased losses in the windings and hence increase the cost of loss.

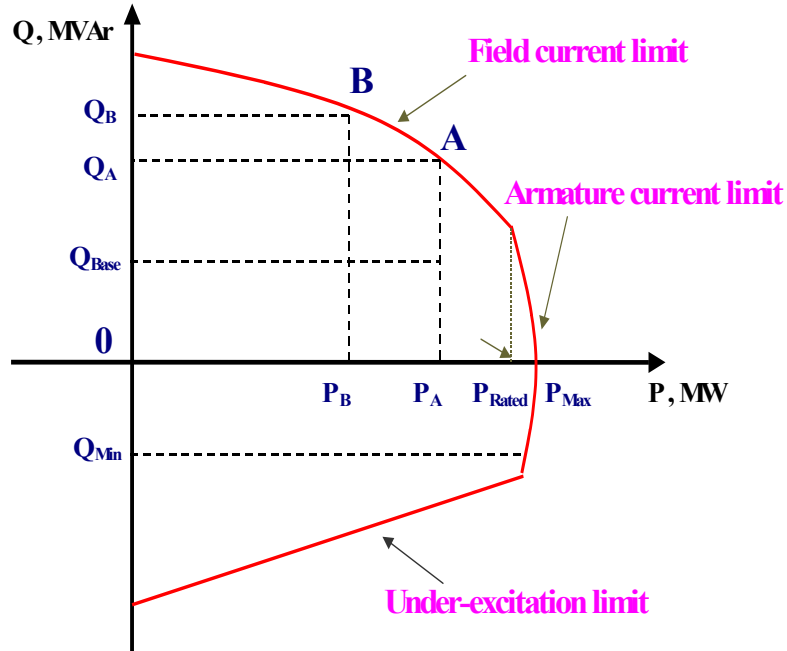

Figure 2.2. Synchronous Generator Capability Curve

If the generator is operating on the limiting curve, any increase in Q will require a decrease in P so as to adhere to the winding heating limits. Consider the operating point 'A' on the curve defined by (P_A, Q_A) . If more reactive power is required from the unit, say Q_B , the operating point requires shifting back along the curve to point B (P_B, Q_B) , where $P_B < P_A$. This signifies that the unit has to reduce its real power output to adhere to field heating limits when higher reactive power is demanded.

Figure 2.2 also includes a lower limit on Q , which restricts the unit operation in under-excited mode due to localized heating in the end region of the armature.

It is seen from Figure 2.2 that field and armature limits restrict reactive power provision and the fulfillment of contracted transactions. In all the three reactive power procurement models, to be discussed in this thesis, we consider synchronous generator capability curve as an important factor.

2.3 PROPOSED STRUCTURE OF THE REACTIVE POWER MARKET

To begin with, we define two terms that will be used for the development of the reactive power market.

(a) *Expected Payment Function (EPF)* - generators providing reactive power services incur various costs depending on their operating regime. While some of these costs are very difficult to differentiate from other costs, some are difficult to quantify. A comprehensive analysis of these costs has been provided in [24]. Under deregulation, a proper financial mechanism must exist for compensating these costs. The EPF is a mathematical formulation, to be developed subsequently, of cost components vis-à-vis the generator's expectation of payment for these components.

(b) *Cost of Loss* - is one of the components of EPF. Reactive power supplied or absorbed by a generator increases the real power loss in field windings. The power thus lost, is a non-linear function of reactive power [25]. Although this component is much smaller compared to other losses in the system, it needs to be accounted for. This will be referred to as *cost of loss*.

2.3.1 Cost of Reactive Power Production

We have discussed in Section-2.2 the reactive power generation capability of synchronous generators. In Figure 2.2, assume that a unit is operating at (P_A, Q_{base}) . If the unit is required to increase its reactive power production from Q_{base} to Q_A , it will incur increased losses in the windings and hence increase in its costs. This cost is the *cost of loss component* and is incurred by the synchronous generator with reactive power production (both lagging and leading). A typical reactive power versus loss plot has been shown in [25].

For reactive power production higher than Q_A , the generator has to reduce its real power generation in order to meet the constraints imposed by field or armature heating limits. It will hence incur revenue loss (RL), which needs to be compensated net of its cost savings from reduced generation, expressed as follows:

$$RL = \mu(P_A - P_B) - [C(P_A) - C(P_B)] \quad (2.3)$$

In (2.3), μ is the real power price and $C(\cdot)$ is the generation cost as a function of real power production. The term RL can also be called the *opportunity cost component* of reactive power generation for the generator.

The above two components are explained in Figure 2.3. However, it is to be noted that the nature of the plot shown is only figurative to illustrate the two components *i.e.* the cost of loss plot need not necessarily be a parabolic curve nor the other component is necessarily parabolic.

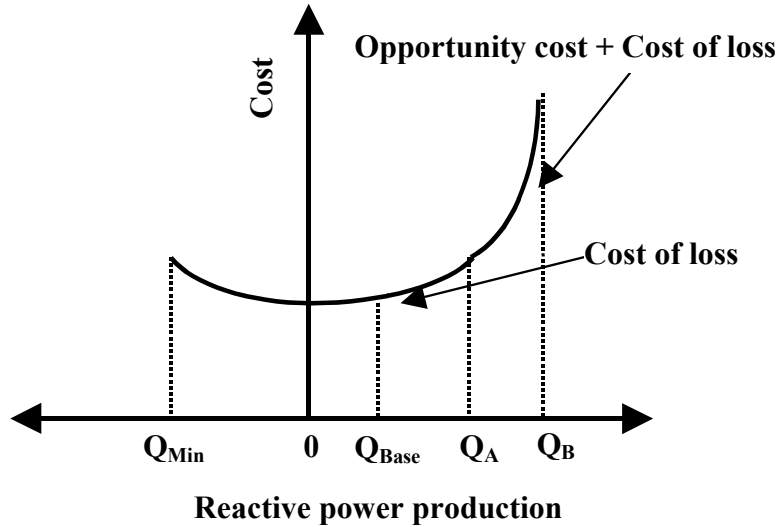

Figure 2.3. Reactive power production versus increased costs incurred by a synchronous generator

Understandably, the ISO will not be in a position to determine these two components for a generator since information on real power prices may not be known to the ISO if these are fixed through a bilateral contract, nor will the generator's *cost of loss function* be known.

An appropriate option in such a case is to call for *reactive power offers* from all generators. A possible structure of such reactive power offers, which the ISO should call for, from independent generators, is discussed in the next section.

2.3.2 Structure of Reactive Power Offers from Generators

As we have discussed in Section-2.3.1, the ISO would require calling for reactive power offers from generators and other participants in the reactive power market - depending on the market design. In this section we consider the possible reactive power offer structure of synchronous generators.

We define three operating regions of a synchronous generator on the reactive power co-ordinate to formulate the generator's *Expectation of Payment Function (EPF)*. An analysis and understanding of the EPF is desirable on the part of the ISO also, so as to retain control over the market and prevent unwarranted payments made due to an irrational bidding structure.

The operating regions on the reactive co-ordinate can be defined as follows (Refer Figure 2.2):

Region-I: 0 to Q_{base} : Production in this region caters for the reactive power needed by the generator to maintain its own equipment. This includes reactive consumption by unit's auxiliaries (such as boiler feed pump motors, circulating water system pump motors, induced draft fan motors, forced draft fan motors, step-up transformers, *etc.*). Therefore any reactive power generated in this region does not qualify as an ancillary service.

*The generator should not be entitled to receive any payment
for reactive power production in Region-I.*

$$EPF = 0$$

However, it may be very difficult for the ISO to determine Q_{base} , unless the generator reports this parameter correctly, which may be unlikely, given the competitive market environment. One way to go about this, is to pre-calculate the technical requirements based on machine and equipment ratings and decide on certain standard Q_{base} , which does not qualify for payment. For example, setting a qualifying limit of 0.95 lagging power factor may be one of the ways.

Region-II: (Q_{base} to Q_A) and (0 to Q_{Min}): This region denotes that amount of reactive power, which the generator can provide or absorb, without having to reschedule its real power generation. However, as mentioned earlier, this will increase the generator's real power losses in the windings. These losses increase with the amount of reactive power generated or absorbed. Therefore, the generator will expect to be paid for the cost of losses (probably at the prevailing spot-market rates) and also for making available its service.

This payment structure is very difficult to formulate because of the complexity involved in determining the availability payment. Probably this can be found by the ISO by determining the cost to the system due to its unavailability - the opportunity cost of not having the service of the generator. Also, determining the cost of loss can be difficult due to the variation of system prices and machine parameters.

The generator is entitled to receive 2 components of payments in Region-II

$$EPF = \text{Availability component} + \text{Cost of Loss Component}$$

Region-III: Q_A to Q_B : This region denotes that amount of reactive power which a generator is willing to produce, at the cost of having to reduce its

own real power generation. The generator stands to lose revenue from the unfulfilled real power selling contracts. The financial compensation that the generator expects from its reactive power service is the revenue lost due to its scheduled real power sell, given by (2.3).

The generator is entitled to receive payment commensurate with its opportunity cost of reduced real power production

EPF = Availability Cost + Cost of Loss + Opportunity Cost

However, the ISO will not be in a position to estimate the EPF for a generator in deregulated markets. An appropriate option for the ISO is to call for reactive power offers from all generators based on the EPF structure. A possible structure of such reactive offers is discussed as following.

Based on the classification of reactive power production costs, a generalized EPF and hence an offer structure can be formulated mathematically.

$$EPF_i = a_{o,i} + \int_{Q_{Min}}^0 m_{1i} \cdot dQ_i + \int_{Q_{base}}^{Q_A} m_{2i} \cdot dQ_i + \int_{Q_A}^{Q_B} (m_{3i} \cdot Q_i) \cdot dQ_i \quad (2.4)$$

The coefficients in (2.4) represent the various components of reactive power cost incurred by provider i that need to be offered in the market. These are explained as follows:

- a_o : Availability price offer, in \$
- m_1 : Cost of loss price offer for operating in under-excited mode (absorb reactive power), $Q_{Min} \leq Q \leq 0$, \$/MVArh
- m_2 : Cost of loss price offer for operating in the region $Q_{Base} \leq Q \leq Q_A$, \$/MVArh
- m_3Q : Opportunity price offer for operating in the region $Q_A \leq Q \leq Q_B$, (\$/MVArh)/MVArh. Note that the opportunity price offer is a function of reactive power output and hence the corresponding EPF component will be a quadratic function of Q .

The generalized EPF vis-à-vis the offer parameters, discussed above, are shown in Figure 2.4. Note that the above discussions also hold for synchronous condensers, except the opportunity cost component. Synchronous condensers will be assumed to offer all components, except the opportunity price.

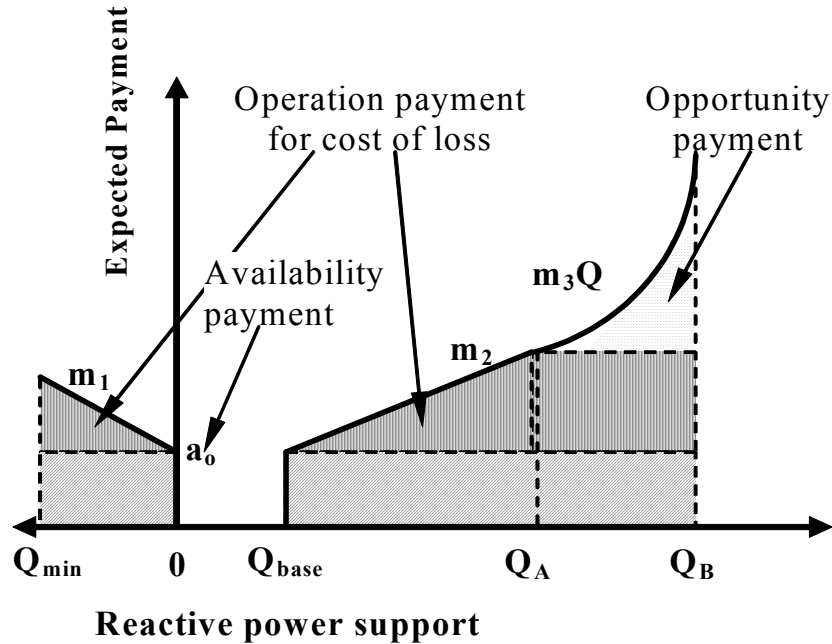

Figure 2.4. Structure of Reactive Power Offers from Providers

We should note here that the 'availability' offer typically represents a part of the generator's capital cost that goes towards providing reactive power. This is annualized and further reduced on a day's scale. Understandably, this is very difficult to separate from the total capital cost, but in any case, is a small fraction only. The 'cost of loss offer' represents the generator's operational costs in providing the service. These two components are therefore not very different in magnitude, both being of similar orders in the model.

2.4 OPTIMAL PROCUREMENT OF REACTIVE POWER

SERVICES

With a reactive power offer structure established in Section-2.3, the ISO requires a proper criterion to determine the best offers and thus formulate its reactive power procurement plan. Unlike real power markets where bids are selected in ascending order of prices, reactive power markets need to consider the location aspects also because of the transmission loss considerations.

For example, a low priced reactive power offer at a bus remotely located is not necessarily an attractive option for the ISO. On the other hand, even a

somewhat expensive reactive power offer at a heavily loaded demand center could well be considered for procurement.

We consider the ISO's problem of obtaining optimal reactive power contracts, assuming that the reactive power providers offer their prices to the ISO rationally.

The reactive power providers can enter into either long or short-term contracts with the ISO for reactive power provision. Contracted provisions involve payments to be made by the ISO, and it remains an objective of the ISO to procure the service so as to minimize the total payment while meeting the system constraints. Although this is a seemingly fair enough objective, such an optimal selection can result in increased losses in the system or may require curtailment of real power transaction contracts, both of which are undesirable. Increased energy loss requires the ISO to increase its procurement of *loss compensation services* from balance providers (generators or loads) involving additional payments. Thus, a *minimum payment* objective may not necessarily satisfy all the concerns of the ISO.

A two-step method is proposed in this chapter to address the problem of optimal reactive power procurement considering both technical and financial efficiency of the ISO. The method can be summarized as follows:

Step-I: The ISO determines the marginal benefit to the system from each reactive power offer with respect to system losses.

Step-II: Having obtained the marginal benefit from each reactive power offer, the ISO seeks to maximize a societal advantage function (SAF).

2.4.1 Marginal Benefit from a Reactive Power Service

The marginal benefit to the system from one unit of reactive power support at a bus can be determined from the dual of the system constraints of an appropriate OPF model representing the grid. Consider the following modified OPF:

Minimize: System transmission losses,

$$\text{Loss} = 0.5 \sum_{i,j} \left(G_{i,j} \times (V_i^2 + V_j^2 - 2V_i V_j \cos(\delta_j - \delta_i)) \right) \quad (2.5)$$

Subject to the following constraints:

Load flow equations:

$$PG_i^{con} - \sum_{gen} XP_{i,gen} = \sum_j V_i V_j Y_{ij} \cos(\theta_{ij} + \delta_j - \delta_i) \quad (2.6)$$

$$Q_i - QD_i = -\sum_j V_i V_j Y_{ij} \sin(\theta_{ij} + \delta_j - \delta_i) \quad (2.7)$$

Bus voltage limits:

$$\underline{V}_i \leq V_i \leq \overline{V}_i \quad (2.8)$$

Limit on bilateral transactions:

$$0 \leq XP_{i,gen} \leq XP_{i,gen}^{con} \quad (2.9)$$

$XP_{i,gen}^{con}$ is the contracted real power transaction by a load at bus i with a generator gen . The bilateral transactions are modeled using the method discussed in Appendix-A.

Reactive power capability limit of generators:

$$Q_i \leq \sqrt{\left(\frac{V_t E_{af}}{X_s}\right)^2 - (PG_i^{con})^2} - \frac{V_t^2}{X_s} \quad (2.10)$$

$$Q_i \leq \sqrt{V_t I_a^2 - (PG_i^{con})^2} \quad (2.11)$$

Equation (2.10) is applicable when the field heating limit acts as the upper limit (*i.e.* for $P_A < P_R$) and (2.11) when the armature heating limit is applicable (*i.e.* for $P_A > P_R$).

Lower limits on reactive power generation:

As mentioned in Section-2.2, the under-excitation limit, Q_{Min} , is fixed *a priori* and hence the lower limit of reactive power generation is governed by the constraint,

$$Q_{Min,i} \leq Q_i \quad (2.12)$$

For the modified OPF described by equations ((2.5) to (2.12)), we define three sets of Lagrange multipliers, λ , γ , μ , associated with the three reactive power constraints (2.7),(2.10),(2.12) to derive important conclusions.

2.4.1.1 Dual of the nodal reactive power balance constraint: λ

The dual of the nodal reactive power balance equation (2.7) denotes the sensitivity of the system loss parameter to change in reactive power injection at a bus.

λ is in unit of MW/MVAr denoting the change in MW loss per MVAr change in reactive power injection. When λ is multiplied with a cost parameter C_L (in \$/MW) denoting the economic worth of reduced loss, the *marginal benefit (MB)*, to the ISO from reactive power injection at a bus is obtained.

$$MB_i = \lambda_i \cdot C_L \quad \text{in } \$/\text{MVAr} \quad (2.13)$$

2.4.1.2 Dual of the generator reactive power capability constraint: γ

When the generator is operating at its reactive power capability limits, it is of interest to know how the system will benefit if the generator increases its reactive power output by backing down real power generation. The dual of constraints (2.10) and (2.11), while minimizing the system loss, provides important insight on these lines.

Thus, γ_{gen} indicates by how much the system loss will change for a unit change in generator reactive power capability. A value of $\gamma = 0$ indicates that the reactive power generation is below the limit specified by field or armature current limits (*i.e.* referring to Figure 2.2, if $P = P_A$, $Q < Q_A$). If $\gamma < 0$, it indicates that the system losses will reduce if reactive power generation is increased (*i.e.*, $Q > Q_A$) by reducing real power generation. If $\gamma > 0$, it indicates that the system losses will increase if reactive power generation is increased beyond the limit. In such a case, it is not desirable to generate additional reactive power by reducing real power output.

The marginal benefit to the ISO from a generator supplying reactive power at its field or armature winding heating limit is given by,

$$MB_{gen} = \gamma_{gen} \cdot C_L \quad \text{in } \$/\text{MVAr} \quad (2.14)$$

2.4.1.3 Dual of the under excitation constraint on reactive power

generation: μ

This parameter is the dual associated with the under-excitation constraint (2.12) which determines the lower limit of reactive power generation. Therefore,

$$MB_i = \mu_i \cdot C_L \quad \text{in } \$/\text{MVA} \quad (2.15)$$

2.4.2 Optimal Reactive Power Procurement

2.4.2.1 Societal Advantage Function of the ISO

Marginal benefit of reactive power support at each bus, and bid parameters m_2 and m_3 for each reactive power provider, are now available to the ISO. Here, we suppose $a_0=0$, $m_1=0$ and $Q_{\text{base}}=0$. Then, we can define the composite Societal Advantage Function (SAF) for the ISO as follows:

$$SAF = \sum_{gen} \left(C_L \cdot \lambda_{gen} - m_{2gen} \right) \cdot Q_{2gen} + \sum_{gen} \left(\left(C_L \cdot \gamma_{gen} - m_{2gen} \right) \cdot Q_{3gen} - \frac{1}{2} m_{3gen} \cdot \left(Q_{3gen} - Q_A \right)^2 \right) \quad (2.16)$$

In (2.16), Q_2 and Q_3 represent the reactive power in regions II and III mentioned in Section- 2.3.2, respectively. The societal advantage function desired in (2.16) represents from the ISO's viewpoint. The net "welfare" to the system in terms of loss reduction is due to reactive power injection at a bus, while taking into account the gross benefits from that injection and their associated prices.

2.4.2.2 SAF Maximization

Once the ISO's composite advantage function is constructed as in (2.16), the reactive power procurement plan can be obtained from a second stage optimization model constructed using the information now available.

Maximize: the Societal Advantage Function given by (2.16).

Subject to the following constraints:

- *Load Flow Equations ((2.6),(2.7))*
- *Bus Voltage Limits (2.8)*

- *Limit on Bilateral Transaction (2.9)*
- *Reactive power generation limits:*

In Section-2.4.1 we considered that the upper limit on reactive power is constrained by the field or armature heating limits. Now we consider that the generator is willing to reduce its real power output from P_A to P_B (refer Figure 2.2) in order to provide higher reactive power (for a price). The constraint (2.17) states that the maximum reactive power support available from a generator is Q_B for an operating point, P_A .

$$Q_{Min,i} \leq Q_i \leq Q_{B,i} \quad (2.17)$$

- *Reactive power generation relational constraints:*

According to the regions on the reactive power domain, discussed in Section-2.3.2, the reactive power output Q from a generator can be classified in any of the three components: Q_1 , Q_2 or Q_3 , to represent region (Q_{min}, Q_{base}) , (Q_{base}, Q_A) or (Q_A, Q_B) , respectively. The governing algebraic relations between them can be written as follows.

$$Q_i = Q_{1i} + Q_{2i} + Q_{3i} \quad (2.18)$$

$$W_{1i} \cdot Q_{mini} \leq Q_{1i} \leq W_{1i} \cdot Q_{Basei}$$

$$W_{2i} \cdot Q_{Basei} \leq Q_{2i} \leq W_{2i} \cdot Q_{Ai} \quad (2.19)$$

$$W_{3i} \cdot Q_{Ai} \leq Q_{3i} \leq W_{3i} \cdot Q_{Bi}$$

$$W_{1i} + W_{2i} + W_{3i} \leq 1 \quad (2.20)$$

W_1 , W_2 and W_3 are binary variables for the discrete selection of a reactive power component from any of the three regions. According to (2.20) only one of the binary variables can be selected. This automatically restricts that Q can be in only one of the bidding regions shown in Figure 2.4.

2.5 SIMULATIONS ON CIGRÉ 32-BUS SYSTEM: RESULTS AND DISCUSSIONS

The Cigré 32-bus test system described in Appendix-A and shown in Figure A.1, is used in this chapter to evaluate the optimal reactive power procurement plan for the ISO. The bilateral contract transactions between

suppliers and consumers are obtained using the method described in Appendix-B. Bus 4011 is selected as slack bus to balance the deviation from transactions and provide for system losses.

2.5.1 Step-I: Obtain Marginal Benefit from Reactive Power

Support at a Bus

The marginal benefit to the system from reactive power support at a bus is obtained by solving the modified OPF model discussed in Section-2.4.1. This model is a non-linear programming problem and is solved using the high-level programming platform General Algebraic Modeling System (GAMS) and non-linear programming solver MINOS-5 [26].

λ , γ , and μ associated with each generator's reactive power constraints have been listed in Table 2.2. The corresponding marginal benefits are determined from λ , γ and μ and (2.13)-(2.15), assuming $C_L = \$100/\text{MW}$. The reactive power offers, m_2 and m_3 , from all generators are also listed in Table 2.2.

The optimum reactive power support, Q , which evolves from the model solution, is also shown. Either the field or the armature winding heating limit, according to the operating condition, specifies the upper limit Q^{Max} while the lower limit Q^{Min} is fixed *a priori*. Accordingly, either γ or μ assumes a non-zero value if Q touches the upper or lower limit respectively. The corresponding λ is equal and negative in sign. The Lagrange multipliers are zero if Q lies between the range of Q^{Max} and Q^{Min} . Therefore, the reactive power support plan, which evolves in Table 2.2 adheres to the field or armature heating limits, as appropriate.

The ISO achieves a minimum transmission loss of 3.67 p.u.MW with the above reactive power procurement plan. However, if the associated offer prices of respective reactive power support are accounted for, we see that the ISO ends up with a very high and negative societal advantage value of minus \$862.0/hr from the above plan. This is not desirable from the ISO's viewpoint in deregulated electricity markets.

Table 2.2. Marginal values and optimal reactive power scheme

Bus	λ	γ	μ	m_2	m_3	Q	Q^{Max}	Q^{Min}
4072	0	0	0	1.25	0.06	4.67	12.78	-7.5
4071	0.0014	-0.0014	0	0.1	0.07	1.12	1.12	-0.84
4011	0	0	0	0.24	0.09	-1.46	2.52	-1.67
4012	0	0	0	0.67	0.04	-1.24	2.19	-1.33
4021	-0.0776	0	0.0776	0.72	0.07	-0.5	0.82	-0.5
4031	0	0	0	0.61	0.05	-0.08	0.98	-0.59
4042	-0.02	0	0.02	1.7	0.07	0	2.95	0
4062	-0.005	0	0.005	0.4	0.05	0	1.33	0
4063	0	0	0	0.86	0.05	1.84	5.44	0
4051	0	0	0	0.37	0.09	0.53	2.83	0
4047	-0.0112	0	0.0112	0.75	0.05	0	2.5	0
2032	0	0	0	0.89	0.02	1.26	2.12	-1.42
1013	0	0	0	0.63	0.06	0.66	1.25	-1.0
1012	0.0011	-0.0011	0	0.92	0.03	1.85	1.85	-1.33
1014	0	0	0	0.20	0.05	0.36	2.01	-1.17
1022	0.013	-0.013	0	1.58	0.04	0.61	0.61	-0.67
1021	0	0	0	0.32	0.04	-0.23	1.71	-1.0
1043	-0.014	0	0.014	0.68	0.05	0	0.87	0
Total System Losses						3.67 p.u. MW		
Societal Advantage						- \$ 862.00/hr		

λ , γ and μ are in MW/MVAr; m_2 is in \$/MVAr, m_3 in \$/MVAr/MVAr, Q, Q^{Max} and Q^{Min} are in p.u. MVAr units. We assume: $Q_{\text{Base}} = 0$

2.5.2 Step-II: Final Optimization

The second stage of optimization therefore seeks to find a compromise between the technically best and a financially safe solution for the ISO. Marginal benefits obtained from the first step and the offered prices are used in the final optimization that seeks to maximize the societal advantage function (2.16). This problem (stated in Section-2.4.2) is a mixed-integer non-linear programming problem and is solved using the GAMS/DICOPT solver. GAMS/MINOS5 and GAMS/XA are invoked by DICOPT as the non-linear programming and integer programming solvers respectively.

The optimal reactive power procurement plan obtained after the second step is listed in Table 2.3. Note that now the reactive power plan at certain buses exceeds Q^{Max} (at buses 4071, 4062, 1012 and 1022). These generators will require reducing their real power output to provide the additional reactive power, and will be compensated as per the offer prices. When Q falls in region-III (*ref.* Section-2.3.2), we desegregate Q in two components,

Q_2 and Q'_3 . Q_2 denotes how much it provides within the reactive limits, and Q'_3 shows how much it provides above its reactive limits (by reducing real output).

Table 2.3. Reactive power procurement plan after final optimization

Bus	Q	Q^{Max}	Q_1	Q_2	Q'_3
4072	1.97	12.78	-	1.97	-
4071	1.68	1.12	-	1.12	0.56
4012	-0.49	2.19	-0.49	-	-
4021	-0.5	0.82	-0.5	-	-
4062	2.0	1.33	-	1.33	0.67
1013	1.25	0.66	-	1.25	-
1012	2.78	1.85	-	1.85	0.93
1022	0.91	0.61	-	0.61	0.3
1021	-0.25	1.71	-0.25	-	-
Total System Loss			4.67 p.u. MW		
Societal Advantage			\$ 108.00/hr		

From Table 2.3, we can see that the solution yields a positive and fairly high societal advantage for the ISO (\$108.0/hr). As expected, the system bears a higher transmission loss (4.67 p.u.MW) from this reactive power procurement plan, but this plan is financially safe for the ISO.

2.5.3 Uncertainty in Reactive Power Demand and Offer Prices

The solution obtained in Section-2.5.2 that demonstrates the optimal procurement scheme assumes a particular load condition and a set of reactive power offer prices. Understandably, the solution obtained is a biased solution depending on the nature of input information.

Monte Carlo simulation is used now to model the uncertainty associated with the demand and bid prices. If the distribution form of uncertain parameters is known, the expected behavior of the system can be studied by averaging the outcomes of different simulation cases. Among the advantages of Monte Carlo simulation is its conceptual simplicity *i.e.*, each simulation exercise (or sampling) can be viewed as a possible state of system operation.

The reactive power demand and offer prices have been assigned a range of variation, with a normal distribution for the former and a uniform distribution for the later. Simulations are carried out over the range of uncertainties and the expected outcome is evaluated by averaging over the entire simulation samples.

2.5.3.1 Uncertainty in Reactive Power Demand, Q_D

A normal distribution is considered for simulating the reactive power demand uncertainty. Offer prices are held at their nominal values during this case. The optimal solution is obtained for each Monte Carlo simulation sample using the two-step approach discussed earlier.

The expected reactive power procurement plan is given in Table 2.4 while Figure 2.5 shows the solution convergence to the expected value with increasing sample size of Monte Carlo simulation. For example, the reactive power procurement at bus '4072' converges to 0.49 p.u.MVAr in a Monte Carlo simulation with 200 samples.

The expected reactive power procurement plan in Table 2.4 is somewhat different from the single simulation solution shown in Table 2.3. The expected system loss is less and the expected societal advantage is more than that obtained from the single simulation case. This indicates that the single simulation case was a typically high reactive power demand case simulated. Over a range of reactive power demand, the solution converges around the expectation values, shown in Table 2.4.

Table 2.4. Optimal solution with uncertainty in reactive demand

Bus	Q	Q_1	Q_2	Q'_3
4072	0.49	-	0.49	-
4071	1.60	-	1.12	0.48
4011	0.01	-	0.01	-
4012	-0.88	-0.88	-	-
4021	-0.46	-0.46	-	-
4031	-0.09	-0.09	-	-
4062	0.75	-	0.75	-
2032	0.03	-	0.03	-
1013	0.94	-	0.94	-
1012	2.63	-	1.85	0.78
1014	0.05	-	0.05	-
1022	0.67	-	0.61	0.06
1021	-0.29	-0.29	-	-
1043	0.01	-	0.01	-
Total System Loss			4.52 p.u. MW	
Societal Advantage			\$ 179.00/hr	

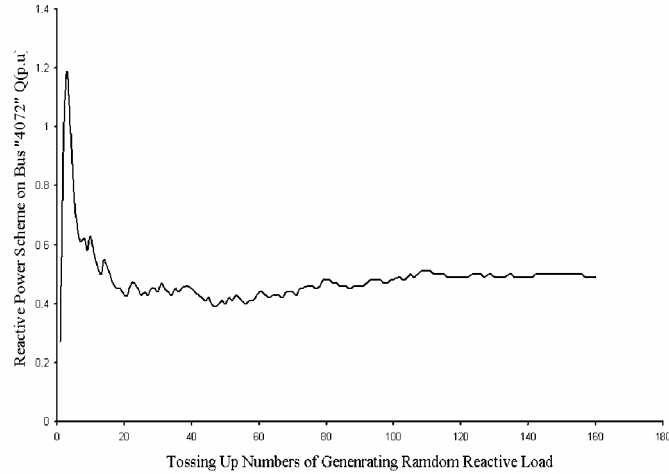

Figure 2.5. Expected Reactive Power Procurement of Bus 4072 with Uncertain Reactive Power Demand

2.5.3.2 Uncertainty in offer price parameters, m_2 and m_3

The uncertainties in m_2 and m_3 are assumed to be uniformly distributed over a range. The optimal solution given in Table 2.5 and Figure 2.6 shows the convergence to the expected values with increasing sample size of Monte Carlo simulation. Reactive power procurement at bus ‘4072’ converges to 0.29 p.u.MVAr with a sample size of 400.

Table 2.5. Optimal solution with uncertainty in bid price

Bus	Q	Q ₁	Q ₂	Q' ₃
4072	0.29	-	0.29	-
4071	1.68	-	1.12	0.56
4011	0.01	-	0.01	-
4012	-0.97	-0.97	-	-
4021	-0.48	-0.48	-	-
4031	-0.02	-0.02	-	-
4062	0.28	-	0.28	-
1013	1.08	-	1.08	-
1012	2.78	-	1.85	0.93
1014	0.05	-	0.05	-
1022	0.91	-	0.61	0.3
1021	-0.27	-0.27	-	-
Total System Loss			4.65 p.u. MW	
Societal Advantage			\$ 101.00	

The expected reactive power procurement plan in Table 2.5 is again somewhat different from the single sample solution of Table 2.3. The large

sample size with Monte Carlo simulations smoothens the otherwise biased single input and introduces fairness in the solution.

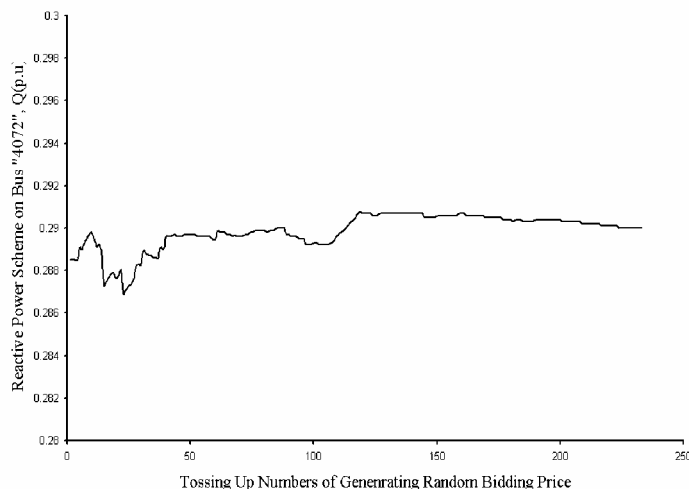

Figure 2.6. Expected Reactive Power on Bus 4072 with Uncertain Bid Prices

2.6 CONCLUDING REMARKS

Procurement of various ancillary services is a complex task for the ISO in deregulated electricity markets. Among various factors that need to be considered, are the benefit to the system from a particular service in terms of system security, economics and reliability, and the cost of the service in terms of payments to be made to the service providers.

Provision for reactive power support and devising appropriate pricing mechanisms for that is an important issue. In this chapter an offer price structure for reactive power ancillary service has been developed. Reactive power capability characteristic of a synchronous generator has been analyzed in detail to formulate an *Expected Payment Function* based on the cost of reactive power production.

We have further discussed the procurement of reactive power services based on the proposed market structure. The marginal benefit to the system from reactive power support at a bus is evaluated using the dual of the reactive power constraints. It is seen that the ISO tends to procure reactive power services from those providers that provide the best societal advantage, *i.e.*, have high marginal benefit from the service while having price offers within acceptable ranges.

It has also been clearly demonstrated that if the ISO uses the classical *loss minimization* objective function for procurement of reactive power services,

it would end up with a high burden of payments. The classical objective is thus not the best suited one, while the new objective function, referred to, in this chapter, as the *societal advantage function*, does clearly provide the ISO with an optimal procurement plan for reactive power services.

CHAPTER 3

TOWARD A COMPETITIVE MARKET FOR REACTIVE POWER^{*}

In Chapter-2, an approach to optimal contracting of reactive power services by the ISO was presented, using the maximization of a *societal advantage function*. This chapter extends the issue further to the creation of a competitive market for reactive power services and determining a possible model for market settlement and obtaining 'uniform' reactive power prices for all providers.

Through conventional load-flow analysis, market players (*i.e.*, reactive power providers) can determine those buses that consistently require high reactive power support. A provider located at such a bus would have significant opportunities to indulge in gaming, given the limited number of potential players in the system. To prevent this-

- If a *uniform price auction* is used to determine the reactive power market prices, the providers will have incentives to offer their true operating and opportunity cost. Since each provider receives a price greater than its offer price in uniform auction, submitting an offer priced above its costs will expose the provider to the risk that the offer is not selected, with a resulting loss of revenue. Thus providers will have a clear incentive not to indulge in gaming but offer prices equal to their costs and quantities equal to their capacity [27].
- It can be argued that nodal *reactive power pricing* methods would motivate new reactive power investments in high demand areas and thereby reduce market power concerns. However, as discussed in [22], such pricing instruments only represent a portion of the true cost of the reactive power service- that associated with fuel cost of real power. The capital and opportunity cost components of reactive power is not be accounted for.

* Some parts of this chapter has been published in the following paper:

- J. Zhong and K. Bhattacharya, "Toward a competitive market for reactive power," *IEEE Transactions on Power Systems*, Vol.17, No.4, November 2002, pp.1206-1215.

Moreover, with the high volatility of nodal prices, such a pricing could lead to highly unstable reactive power markets.

The design of a reactive power market is thus an important issue, and possibilities for gaming and market power need to be eliminated so that the market functions efficiently. In this chapter, we analyze the barriers to the creation of such a competitive market - those existing in the form of 'market power' with certain service providers. When such barriers are identified, the ISO can take corrective steps to remove them and improve the efficiency of the reactive power market.

3.1 MARKET SETTLEMENT AND PRICE FORMATION

The following assumptions are made regarding the design of a reactive power market.

- The ISO or a similar entity operates this market and is the sole contractor of reactive power services with providers. Thus the market is *monopsonistic* in structure. The ISO calls for reactive power offers from the providers.
- The market operates on long-term contracts so that short-term demand fluctuations, reserve conditions, or real power market price spikes do not affect reactive power offer price trends. The market is further assumed to be fairly perfect with rational participants [22].
- The market is settled on first price, uniform auction, which meaning that all selected providers receive a uniform price, which is the highest priced offer accepted. As discussed in [27] and in [28], this provides the players enough incentives to submit offer prices equal to their true costs.

All participating providers submit their offers to the ISO in terms of the four components, as discussed in Section-2.3.2. As mentioned earlier, the opportunity price offer for synchronous condensers is 'zero'. Once these price offers are received, the ISO settles the market and declares the uniform market price for each component separately.

We know that in real-power markets, the offers are stacked in increasing order of prices and that offer intersecting the demand curve determines the market price. However, with reactive power offers, location being an important issue, a low priced offer need not necessarily be attractive if the provider is located at a remote bus. Similarly, an expensive offer, from a

provider at a heavily loaded demand center may be unavoidable and need to be procured.

Therefore settlement of a reactive power market must consider the system configuration and operating conditions in addition to offer prices. While on one hand, reactive power services should seek to minimize the system losses, they should not result in a high payment burden for the ISO. Further, the procured services should also ensure that contracted real power transactions are met and curtailments are kept at a minimum. The ISO is thus faced with a conflicting situation where it has to contract reactive power services to ensure that losses, curtailments and payments, are all within tolerable limits.

To achieve this, a compromise programming approach is proposed here to settle the market and determine the uniform prices, incorporating the following considerations:

- The reactive power market is settled such that the total payment made by the ISO to procure the services, is minimized.
- The ISO aims to satisfy all contracted real power trades between suppliers and customers.
- The transmission losses are minimized.

Four steps are necessary to arrive at the compromise solution and hence the market settlement, which are discussed in the following sub-section.

3.1.1 Market Settlement to Minimize Payment

This sub-section describes reactive power market settlement with *total payment* (J_P) (3.1) as the objective for minimization. The total payment shall depend on the market price of the four components of reactive power service, being offered by the providers.

$$J_P = \sum_{gen} (\rho_0 \cdot W_{0,i} - \rho_1 \cdot W_{1,i} \cdot Q_{1,i} + \rho_2 \cdot W_{2,i} \cdot Q_{2,i} + \rho_2 \cdot W_{3,i} \cdot Q_{A,i} + \frac{1}{2} \rho_3 \cdot W_{3,i} \cdot Q_{3,i}^2) \quad (3.1)$$

Reactive power output from a provider is classified into three components: Q_1 , Q_2 or Q_3 , to represent the regions $(Q_{\min}, 0)$, (Q_{base}, Q_A) and (Q_A, Q_B) , respectively. Accordingly, only one of the binary variables W_1 , W_2 and W_3 can be selected. In (3.1), ρ_0 is the *uniform availability price*, ρ_1 and ρ_2 are the *uniform cost of loss prices* while ρ_3 is the *uniform opportunity price*. If a

provider is selected, W_o will be 1 and it will receive the availability price irrespective of its reactive power output. The system constraints are as follows:

Load Flow Equations:

$$PG_i^{con} - \sum_{gen} XP_{i,gen} = \sum_j V_i V_j Y_{ij} \cos(\theta_{ij} + \delta_j - \delta_i) \quad (3.2)$$

$$Q_i - QD_i + QC_i = -\sum_j V_i V_j Y_{ij} \sin(\theta_{ij} + \delta_j - \delta_i) \quad (3.3)$$

Reactive Power Relational Constraints and Limits:

As per the reactive power offer regions, discussed in Section-2.3.2, a set of governing algebraic relations are required to ensure appropriate allocation. These can be written as follows.

$$Q_i = Q_{1i} + Q_{2i} + Q_{3i} \quad (3.4)$$

$$\begin{aligned} W_{1i} \cdot Q_{Min,i} &\leq Q_{1i} \leq W_{1i} \cdot Q_{base,i} \\ W_{2i} \cdot Q_{base,i} &\leq Q_{2i} \leq W_{2i} \cdot Q_{Ai} \\ W_{3i} \cdot Q_{A,i} &\leq Q_{3,i} \leq W_{3i} \cdot Q_{Bi} \end{aligned} \quad (3.5)$$

$$W_{1,i} + W_{2,i} + W_{3,i} \leq 1 \quad (3.6)$$

Determining the Market Prices:

The market prices are determined separately for each component of reactive power. The following constraints ensure that the market price, for a given set of offers, is the highest priced offer accepted.

$$W_{0,i} \cdot a_{o,i} \leq \rho_o \quad (3.7)$$

$$W_{1,i} \cdot m_{1,i} \leq \rho_1 \quad (3.8)$$

$$(W_{2,i} + W_{3,i}) \cdot m_{2,i} \leq \rho_2 \quad (3.9)$$

$$W_{3,i} \cdot m_{3,i} \leq \rho_3 \quad (3.10)$$

$$W_{0,i} = W_{1,i} + W_{2,i} + W_{3,i} \quad \forall i \in gen \quad (3.11)$$

Reactive Power Generation Limits:

$$Q_{Min,i} \leq Q_i \leq Q_{B,i} \quad (3.12)$$

$$QC_{Min,i} \leq QC_i \leq QC_{max,i} \quad (3.13)$$

In (3.12), the upper limit on reactive power output from a generator is Q_B (refer Figure 2.2) which takes into account the opportunity component. Q_C in (3.13) is the reactive power support from other reactive sources, *e.g.*, capacitor banks. These are not included in the market since these are not considered ancillary services.

Bus Voltage Limits

$$\begin{aligned} V_i^{Min} \leq V_i \leq V_i^{Max} & \quad \forall \quad i \in \text{load bus} \\ |V_i| = \text{constant} & \quad \forall \quad i \in \text{PV bus} \end{aligned} \quad (3.14)$$

Limit on Bilateral Transactions:

This constraint ensures that all bilateral transactions are within pre-specified limits. The bilateral transactions are modeled using the method discussed in Appendix-A.

$$0 \leq XP_{i,gen} \leq XP_{i,gen}^{con} \quad (3.15)$$

$XP_{i,gen}^{con}$ is the contracted real power transaction by a load at bus i with generator gen . $XP_{i,gen}$ is the decision variable and denotes the actual transaction allowed by ISO.

3.1.2 Market Settlement to Minimize Transmission Losses

This model describes the procurement of reactive power services to minimize transmission losses (J_L) (3.16) and is similar to a classical reactive power optimization problem. Market prices are determined *ex post*. That means, after the optimal solution is obtained, the highest priced offer selected determines the uniform price. The model is described below.

$$J_L = 0.5 \times \sum_{i,j} \left(G_{i,j} \times \left(V_i^2 + V_j^2 - 2V_i V_j \cos(\theta_j - \theta_i) \right) \right) \quad (3.16)$$

The constraints are as follows:

- *Load Flow Equations (3.2), (3.3)*
- *Reactive power generation limits (3.12), (3.13)*
- *Bus Voltage Limits (3.14)*
- *Limit on Bilateral Transactions (3.15)*

3.1.3 Market Settlement to Minimize Deviation from Contracted Transactions

This model ensures that the procured reactive power contracts minimize deviations from contracted transactions (J_D). This therefore also ensures that curtailment of power transactions is minimized. As in the case of minimizing transmission losses, the market prices are determined ex post. The model is described below. J_D represents the difference between contracted transactions (between generators and loads) and actual transactions permitted by the ISO.

$$J_D = \sum_{i,gen} (XP_{i,gen}^{con} - XP_{i,gen}) \quad (3.17)$$

The constraints are as follows:

- *Load Flow Equations (3.2), (3.3)*
- *Reactive Power Generation Limits (3.12), (3.13)*
- *Bus Voltage Limits (3.14)*
- *Limit on Bilateral Transactions (3.15)*

3.1.4 Market Settlement to Minimize the Compromise Function

It is seen that the reactive power market can be based on different objective functions for the ISO. For example, in the previous sub-sections we have formulated markets that

- 1) seek to achieve the minimum market price- consumer payment minimization
- 2) minimize losses
- 3) minimize deviations from contracted transactions

While each model independently seeks important targets, an ISO would often desire to achieve all the three targets simultaneously. To achieve that, we propose a 'compromise programming' model that attains the 'best compromise' among the conflicting objectives [29], [30]. The three objectives can be combined into a 'compromise function' (3.18), which when minimized, will represent the ISO's requirement of meeting contradictory objectives simultaneously.

$$J_{Compromise} = \sqrt{\left(\frac{J_P}{J_P^*}\right)^2 + \left(\frac{J_L}{J_L^*}\right)^2 + \left(\frac{J_D}{J_D^*}\right)^2} \quad (3.18)$$

J_P^* , J_L^* and J_D^* are the respective minimum values when J_P , J_L and J_D are optimized independently. Note that while we have used an equal weight for each conflicting component in (3.18), this need not necessarily be the case in actual markets. The ISO may choose to have a priority on the objectives, depending on the market condition. For example, if the participants are willing to pay for increased losses in order to have their transactions fulfilled, the weight on J_L could be very small. Thus, the choice of weights to be associated with the three components of (3.18) should be made by the ISO, as per its decision-making criteria. In this chapter, we consider equal weights of unity for the three components.

The constraints associated with the compromise optimization are same as that for payment minimization, and are listed below.

- *Load Flow Equations (3.2), (3.3)*
- *Reactive Power Relational Constraints & Limits (3.4)-- (3.6)*
- *Determining Uniform Market Prices (3.7) -- (3.11)*
- *Reactive Power Generation Limits (3.12), (3.13)*
- *Bus Voltage Limits (3.14)*
- *Limit on Bilateral Transactions (3.15)*

Finally, the working scheme of the proposed reactive power market is shown in Figure 3.1.

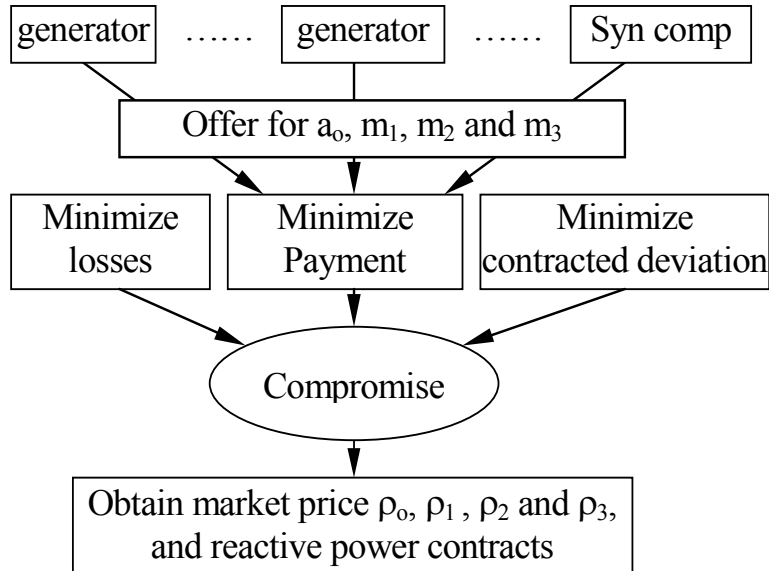

Figure 3.1. Working Scheme of the Proposed Reactive Power Market

3.2 CASE STUDY AND SCENARIO ANALYSES

The same Cigré 32-bus test system used in Chapter-2 (refer Appendix-A), is used to examine the proposed market settlement and contracting scheme. Though this system was initially established for stability studies, we have used the network configuration and base-case load flow data provided, and adopted a steady-state model for our present research.

In order to carry out the analysis, the ISO needs the following information from the reactive power providers:

- *Offer prices:* for four components- a_0 , m_1 , m_2 , and m_3 . In real operation, the ISO will receive this information directly from providers. For our analysis we use a uniform random number generator to simulate the offer prices.
- *Reactive capability:* The providers are required to make available information on Q_{Base} , Q_A and Q_B (ref. Fig. 1). For our analysis, we assume $Q_{\text{Base}} = 0.10 * Q_{\text{Max}}$, Q_A is limited either by the field or the armature heating limit, as per operating condition, and $Q_B = 1.5 * Q_A$ is assumed.

3.2.1 Simulation Results and Discussions

3.2.1.1 Base Case: Optimal Contracts and Market Settlement

In the base case, we assume that all bus loading are at their nominal levels, the providers are rational participants in the reactive power market and offer their true expected payment function. The bus-wise offer prices from all providers are given in Table 3.1.

As mentioned earlier, each provider offers four components, the availability offer a_o , the cost of loss offer m_1 and m_2 , and opportunity offer m_3 . Note that a synchronous condenser is located at bus “4041” and its opportunity price offer is zero. Based on submitted offers, the market settlement scheme is run as discussed in Section-3.1. The optimal reactive power contracts, obtained from each step, and the final compromise solution, are provided in Table 3.1. The following observations are made from the results in Table 3.1.

- a. Based on the compromise solution, the ISO contracts the following providers-generator at buses: “4072”, “4011”, “4012”, “4062”, “1013”, “1012” and “1022”.
- b. Amongst the contracted generators, “4011”, “1013” and “1022” are also contracted for their opportunity component.
- c. Market prices are determined by the highest offer in each category from selected providers. Thus, we get $\rho_o = \$0.96$, $\rho_2 = \$0.90/\text{MVArh}$ and $\rho_3 = \$0.25/\text{MVArh}$, and generators “4072”, “4062” and “4011” are the corresponding price-setters. The under-excited operation market price is zero, *i.e.*, $\rho_1 = 0$, since no offer is selected from this category.

It can be seen from Table 3.1 that, if the ISO minimizes losses or transaction deviations only, it would need to contract almost all the offers in the market, and a significant number of them for the opportunity component. Though losses or deviations would be low, its financial burden would be very high. When the ISO seeks to minimize total payment only, it contracts for much less reactive power support while bearing a burden of increased losses and transaction deviations.

In the compromise solution, the total reactive power contracted, and the number of contracted parties, is kept at a fairly rational level without jeopardizing the system loss or transaction deviation standards. The total payment, losses and deviations achieved from the compromise optimization are fairly close to that obtained when these are individually minimized. The

uniform prices achieved for each component, in the compromise solution, are also close to the lowest value achievable from the individual minimization.

Table 3.1. Reactive power offers and optimal contracts in base case

Bus	Offer Prices (a_0, m_1, m_2, m_3)	Reactive Contracts in p.u.MVAr			
		Minimize Payment	Minimize Losses	Minimize Deviation	Compromise Solution
4072	(0.96 , 0.86, 0.86, 0.46)	4.59	4.6	5.73	5.73
4071	(0.40, 0.41, 0.41, 0.20)	1.68*	1.68*	1.68*	0
4011	(0.77, 0.75, 0.75, 0.25)	3.77*	3.77*	3.77*	3.77*
4012	(0.43, 0.41, 0.41, 0.19)	2.07	0.7	3.28*	1.75
4021	(0.50, 0.54, 0.54, 0.28)	0	1.23*	1.23*	0
4031	(0.42, 0.42, 0.42, 0.17)	0	1.47*	1.47*	0
4042	(0.69, 0.68, 0.68, 0.39)	0	0.32	4.43*	0
4041	(0.91, 0.99, 0.99, 0.00)	0	-1.37	1.06	0
4062	(0.85, 0.90, 0.90 , 0.45)	0	0	0	0.21
4063	(0.90, 0.97, 0.97, 0.42)	0	0.20	0.18	0
4051	(0.73, 0.79, 0.79, 0.44)	0	0	0	0
4047	(0.73, 0.86, 0.86, 0.31)	0	0	0.05	0
2032	(0.88, 0.80, 0.80, 0.39)	0	1.42	3.17*	0
1013	(0.65, 0.59, 0.59, 0.21)	1.88*	0.35	1.88*	1.88*
1012	(0.76, 0.81, 0.81, 0.37)	1.33	2.78*	2.78*	1.85
1014	(0.93, 0.89, 0.89, 0.40)	0	0.21	2.32*	0
1022	(0.50, 0.58, 0.58, 0.25)	0	0.91*	0.91*	0.91*
1021	(0.92, 0.85, 0.85, 0.55)	0	-0.27	0.15	0
1043	(0.77, 0.69, 0.69, 0.37)	0	0	0	0
1042	(0.50, 0.50, 0.50, 0.26)	0	0	0	0
ISO'S BURDEN FROM THESE CONTRACTS					
Total Payment (J_P), \$		19.36	36.53	56.35	21.55
Total Losses (J_L), p.u.		6.61	6.25	8.56	6.75
Total Deviation (J_D), p.u.		17.26	17.19	9.63	13.05
Available Price, ρ_0		0.96	0.96	0.96	0.96
Operation Price, ρ_1		0	0.99	0	0
Operation Price, ρ_2		0.86	0.97	0.99	0.90
Opportunity Price, ρ_3		0.25	0.37	0.40	0.25

Note:

1. Symbol * denotes reactive power support contracted in the range of opportunity costs
2. A bold underscored offer price, (e.g., **0.96**) denotes that the particular offer is the market price setting offer in a particular offer category.

3.2.1.2 Market Power in Reactive Power Markets

We mentioned at the beginning of this chapter that reactive power in a competitive framework could provide strategic advantages to certain participants by virtue of their location vis-a-vis the configuration of the system. In this sub-section we attempt to examine if such strategic advantages do exist with any of the providers in our system, whether certain providers have market power- *i.e.*, do they manage to remain the price setter under all circumstances? If such situations exist, how do we identify those providers? Such information can help the ISO to handle the market for reactive power more efficiently.

Say, the contracted providers from base case presume that their reactive support will always be necessary due to their strategic location in the system and load profile. Consequently, these providers seek market power by offering prices higher than their EPF and try to increase the market price. Five gaming scenarios (S1 to S5) of high offer prices from these providers are constructed below. In S1, all contracted providers offer 20% higher prices than their base-offer, in S2 scenario they offer 30% higher prices, in S3 40% higher, in S4 50% higher and in S5 they offer 60% higher prices. The corresponding optimal reactive power contracts offered by the ISO based on the compromise programming solution are provided in Table 3.2.

From Table 3.2 we can make the following observations:

- a. Generator “4072” remains the price-setter for ρ_0 from base-case through all the gaming scenarios.
- b. As in base-case, ρ_1 continues to be zero in all scenarios.
- c. Generator “4062”, which was the price-setter of ρ_2 in base-case, does not remain so, in the gaming scenarios. Generator “4072” becomes the price-setter for this component also.
- d. Generator “4011” was the price-setter of ρ_3 in base-case. In the gaming scenarios, “4021” becomes price-setter in S1, “1012” in S2 and “1013” in S3 to S5.

From the above observations, we can say that when all base-contracted generators simultaneously indulge in gaming, generator “4072” clearly retains market power and is the price setter for two of the price components. It is also seen that the ISO continues to contract generators “4072”, “4011”, “4012” and “1013”, under all gaming scenarios. However we note that, except for “4072”, the others do not have the capability to set prices in a simultaneous gaming

scenario. This, though, may not be true in an individual gaming scenario, and is examined and discussed next.

Table 3.2. Optimal contracts by the ISO in gaming scenarios

Reactive Contracts in p.u.MVAr in Different Scenarios						
Bus	Base	S1	S2	S3	S4	S5
4072	5.73: ρ_0	5.79: ρ_0, ρ_2	5.84: ρ_0, ρ_2	5.91: ρ_0, ρ_2	5.98: ρ_0, ρ_2	5.96: ρ_0, ρ_2
4011	3.77*: ρ_3	2.52	2.52	2.52	2.52	2.52
4012	1.75	3.28*	2.17	3.28*	3.28*	3.28*
4062	0.21: ρ_2	-	0.21	-	-	-
1013	1.88*	1.88*	1.88*	1.88*: ρ_3	1.88*: ρ_3	1.88*: ρ_3
1012	1.85	-	2.78*: ρ_3	1.85	1.85	1.85
1022	0.91*	-	-	-	-	-
4021	-	1.23*: ρ_3	1.23*	-	-	-
4063	-	0.19	-	0.19	-	0.18
1014	-	1.80	-	-	-	-
4031	-	-	-	1.47*	-	-
2032	-	-	-	-	-	0.86
ISO'S BURDEN FROM THE CONTRACTS						
J_P	21.55	25.26	27.46	29.73	27.22	33.51
J_L	6.75	6.72	6.72	6.74	6.86	6.78
J_D	13.05	13.02	13.02	13.04	14.50	13.08
ρ_0	0.96	1.15	1.24	1.34	1.43	1.53
ρ_1	0	0	0	0	0	0
ρ_2	0.90	1.03	1.12	1.20	1.29	1.38
ρ_3	0.25	0.28	0.37	0.30	0.32	0.34

Note:

1. Symbol * denotes reactive power support contracted in the range of opportunity costs
2. In column-1, the top seven generator buses (shown in bold) are the base-case contracts. Remaining five buses below are those generators which appear in scenarios when the base-case generators offer high prices.
3. When a generator becomes a price-setter for a particular category, it is shown against the reactive power contract along with price ρ_0, ρ_1, ρ_2 or ρ_3 .

We now consider only one of the four generators indulging in gaming, at a time, by increasing its offer price by 60%, while others offer their true EPF. The results are shown in Table 3.3.

Table 3.3. Optimal contracts when one generator indulges in gaming

	p.u.MVAr	Reactive Contracts in p.u.MVAr when this Generator Indulges in Gaming			
Bus	Base	“4072”	“4011”	“4012”	“1013”
4072	5.73: ρ_0	5.80: ρ_0, ρ_2	6.49: ρ_0	5.73: ρ_0	4.62: ρ_0
4011	3.77*: ρ_3	3.77*: ρ_3	-	3.77*: ρ_3	3.77*: ρ_3
4012	1.75	2.19	2.19	1.75	1.44
4062	0.21: ρ_2	-	0.21: ρ_2	0.21: ρ_2	0.20: ρ_2
1013	1.88*	1.88*	1.25	1.88*	-
1012	1.85	1.85	1.85	1.85	1.85
1022	0.91*	-	-	0.91*	-
4021	-	-	0.82	-	-
4063	-	0.18	-	-	-
1014	-	-	2.01	-	2.01
2032	-	0.65	1.85	-	-
4071	-	-	1.12	-	1.68*
1022	-	-	0.61	-	-
ISO's BURDEN FROM THESE CONTRACTS					
J_P	21.55	32.77	26.11	21.55	21.17
J_L	6.75	6.75	6.89	6.75	6.83
J_D	13.05	13.05	13.37	13.05	13.13
ρ_0	0.96	1.53	0.96	0.96	0.96
ρ_1	0	0	0	0	0
ρ_2	0.86	1.38	0.90	0.90	0.90
ρ_3	0.25	0.25	0	0.25	0.25

Note:

1. Symbol * denotes reactive power support contracted in the range of opportunity costs
2. When a generator becomes a price-setter for a particular offer category, it is shown against the reactive power contract along with price ρ_0, ρ_1, ρ_2 or ρ_3 .

From Table 3.3, we observe the following:

- a. When generator “4072” indulges in gaming (see col. 3):
 - i. Generator “4072” retains itself as a price-setter for ρ_0 and increases its market power to become the price-setter for ρ_2 as well.
 - ii. Consequently, ρ_0 and ρ_2 increase significantly from base-case.
 - iii. Though two new generators are contracted in place of “4062” and “1022”, other base-case contracts are still retained by the ISO. The payment burden for ISO increases by 52% for the reactive power services.

- iv. System loss and transaction deviations are maintained at base case levels.
 - v. The ISO cannot avoid contracting reactive support in significant quantities from generator “4072”.
- b. When generator “4011” indulges in gaming (see col. 4):
- i. Generator “4011” gets eliminated from the market. The ISO establishes contracts with several new providers.
 - ii. Prices are at almost similar (if not better) levels as in base-case, through contracts with a wide range of generators. No contract required for opportunity component of reactive power and hence, $\rho_3=0$.
 - iii. ISO pays about 20% more to maintain losses and transaction deviations at same levels as the base case.
- c. When generator “4012” indulges in gaming (see col. 5):
- i. Generator “4012” remains in the market, contracted by the ISO. All other generators contracted in base-case also continue to retain their contracts. The price-setters, price-levels, payment, loss and deviation levels also remain the same as in base-case.
 - ii. In summary, gaming by generator “4012” does not affect the system in any way.
- d. When generator “1013” indulges in gaming (see col. 6):
- i. Generator “1013” gets eliminated from the market and is no longer contracted by the ISO. Some new reactive power contracts are brought in by ISO.
 - ii. The price-setters from base-case stay as price-setters.
 - iii. The price level remains almost the same as the base-case level. Payment, losses and deviations are thus very little affected from base-case.

From the analysis above we conclude that only generator “4072” has the capability to influence market prices and has immense market power. The other generators that continue to remain contracted under all scenarios however cannot exercise market power. If they attempt to do so, they get eliminated from the competition. In summary we can say that the system under investigation does provide a competitive marketplace for reactive power. However, the imperfection arising from the market power of “4072” needs to be removed.

To sum up we note that, the proposed market structure and settlement model implicitly negotiates market power of strategically located providers. For example, if the ISO seeks only loss minimization, it would end up contracting several providers (Table 3.1). Quite a few of them could hold market power in the long run. On the other hand, when the ISO seeks minimum payment, the cheapest offers, irrespective of provider's location and contribution to losses, are contracted. Now, most of the providers who were located at strategic buses from loss minimization approach are eliminated. The same happens with transaction deviation minimization approach. Finally, after the compromise solution is obtained, we are left with seven providers, who are essential to the system from all considerations. Thereafter we carry out analysis to determine if any of the seven providers hold market power by gaming. It is seen that none of the providers except "4072" can hold market power if they indulge in gaming. Thus "4072" is the most critical node and needs 'capital investments'. Only a 'market design' or 'bidding framework' cannot handle the inefficiency existing at this bus.

3.2.2 A Note on Computational Aspects

The reactive power market model to minimize payments (Section-3.1.1) and the composite model minimizing the compromise objective (Section-3.1.4) are mixed-integer non-linear programming (MINLP) problems with presence of non-convexities. The models are solved in Generalized Algebraic Modeling Systems (GAMS), a high-level programming platform, using DICOPT (DIScrete CONTinuous OPTimization) solver. The DICOPT solver is based on the extensions of the outer approximation algorithm for the equality relaxation strategy. It iteratively invokes the MINOS5 and XA10.0 solvers for non-linear programming (NLP) and mixed-integer programming (MIP) solutions respectively [26], [31].

The NLP solution is obtained by MINOS5 by extremizing an augmented Lagrangian function using the reduced gradient algorithm. XA10.0 uses the primal/dual simplex method to obtain the linear programming solution, combined with the 'branch and bound' method to obtain the MIP solution.

Under certain circumstances the solution obtained from DICOPT may not be globally optimum. This can happen when, during the iterative process of the NLP and MIP sub-problems, MINOS5 fails to handle non-convexities. On the other hand, the GAMS/DICOPT algorithm has built-in provisions to handle non-convexities and hence, we can, with a fair degree of confidence, rely on the GAMS/DICOPT optimal solutions to being globally optimal. On

the other hand, it should be mentioned that there is lot of work ongoing in the area of global optimization methods [32], [33] and improved techniques (or solvers with higher confidence levels) would appear in the literature in the coming years.

The reactive power market models minimizing transmission loss (Section-3.1.2) and transaction deviation (Section-3.1.3) are NLP problems, and solved using GAMS/MINOS5 solver.

Both, the GAMS/DICOPT and GAMS/MINOS5 efficiently handle the 32-bus Cigré system considered. However, we should note that the computational burden would inevitably increase for a larger system, particularly so, for the MINLP models. Although algorithms for the solution of MINLP problems have yet not reached the maturity level of NLP or LP problems, there are global optimization methods available in the literature. In this context, global search techniques based on genetic algorithms, simulated annealing, *etc.* have a very promising scope for applications in such problems. In Table 3.4, we present the computational burden involved in order to obtain the optimal solutions for each model. The programs were solved on a Pentium-II 400 MHz computer with 256 MB RAM.

Table 3.4. Computational requirements for solving the model

	Minimize Payment	Minimize Losses	Minimize Deviations	Compromise Solution
Type of Model	MINLP	NLP	NLP	MINLP
Solver Used	DICOPT	MINOS5	MINOS5	DICOPT
No. of Equations	468	208	208	468
No. of Variables	1152	1092	1092	1152
Nonlinear variables	761	761	761	761
Integer variables	59	0	0	59
Model generation time, sec	0.26	0.23	0.20	0.261
Model execution time, sec	0.39	0.26	0.26	0.301
Model solution time, sec	17.148	1.132	0.629	57.129

3.3 CONCLUDING REMARKS

The design of a competitive market for reactive power services in deregulated electricity systems has been attempted in this chapter. The market is based on offers from generators or synchronous condensers for four components of service. The ISO, who is the sole buyer, settles the market using uniform price auction, using a compromise optimization approach, on an optimal power flow based model. The compromise market settlement attains the best possible

solution keeping various contradictory objectives such as total payment, system loss and transaction curtailment, within reasonable limits.

An expected payment function has been formulated based on generator's reactive power capability characteristic and an offer price framework has been proposed. The proposed market structure and settlement model implicitly negotiates price setting by strategically located generators. Additionally, possibility of market power with contracted providers has been examined in detail. Through five scenarios of simultaneous gaming, it is found that generator "4072" retains immense market power and acts as the price-setter for two of the price components. Due to the nature of the system load profile and network configuration, the ISO is compelled to contract generators "4072", "4011", "4012" and "1013", under all circumstances. However, when these generators take recourse to gaming (one generator gaming while others offer rationally) only generator "4072" holds on to its reactive power 'market power'. Other generators end up with reduced contracts or complete elimination from the market. Thus it can be concluded that bus "4072" is one of the strategic buses in the system where a reactive power provider will always have immense market power.

The ISO should seek measures to remove this market power from bus "4072" in order to improve the efficiency of the market. One possible way of removing this market power at bus "4072" is by investing in more reactive support (not necessarily reactive power ancillary service providers, e.g., capacitor banks). This will help reduce the ISO's burden of increased payments as well as reduce the risk of high market prices through gaming.

CHAPTER 4

LOCALIZED REACTIVE POWER MARKETS

USING THE CONCEPT OF VOLTAGE

CONTROL AREAS*

A competitive market for reactive power ancillary services has been proposed in Chapter-3 wherein the market settlement model is based on a uniform price auction and a single price for the whole system is determined for each of the reactive power service components. All the selected reactive power suppliers in the system are paid this uniform price. It has been argued that such uniform prices for all market participants would lead to a fair and competitive market and the participants will not have any incentive to bid higher than their true costs.

In this chapter, we examine the possibility of designing localized reactive power markets for individual voltage control areas of the system. As we have discussed earlier, reactive power and voltage control services are required to be provided locally, and hence the reactive power market can be considered more as a local market than a system-wide market. A local market structure, with a reactive power price for each local area is proposed in the following sections. The concept of electrical distance has been used to break up the system into independent *voltage control areas*. A new payment objective function is developed to get individual uniform prices for each area. The Cigré 32-bus system is used, wherein it is separated into three voltage control areas and the uniform reactive power market prices are obtained for each area respectively.

* Some parts of this chapter has been communicated to publication as the following paper:

- J. Zhong, E. Nobile, A. Bose and K. Bhattacharya, “Localized Reactive Power Markets Using the Concept of Voltage Control Areas”, *IEEE Transactions on Power Systems*.

4.1 CREATING VOLTAGE CONTROL AREAS FROM A WHOLE SYSTEM

A given power system can be separated into some non-overlapping voltage control areas comprising coherent bus groups. A set of buses can be classified as a voltage control area if they are sufficiently uncoupled electrically, from its neighboring areas. And the controllable reactive power in the area should be enough to master the voltage changes of the buses in the area. A criterion of dividing voltage control area is that the voltage profile of one control area is mainly controlled by the reactive power sources in that area, while the controls within the area are very less influenced by other areas [34].

In the French grid, the concept of electrical distance and typological analysis algorithms are used by Electricite de France (EDF) to divide voltage control areas. Their two stage systematic method, which has proved to be effective for determining control areas in French power system, is described in [35]. The first stage of the method is to calculate the electrical distances between buses in the system. The second stage is to group the buses following the typological analysis methods.

In [36], the concept of electrical distance is used to analyze “local” voltage stability problem and assess voltage security. The concept of electrical distance to analysis of competitive ancillary service markets for voltage control in local areas has recently been proposed in [37].

4.1.1 Electrical Distance

The relationships between network bus voltages and currents can be represented using *admittance matrix* “ Y ” or *impedance matrix* “ Z ” written as follows:

$$\begin{bmatrix} \Delta I_1 \\ \Delta I_2 \\ \dots \\ \Delta I_3 \end{bmatrix} = \begin{bmatrix} Y_{11} & Y_{12} & \dots & Y_{1n} \\ Y_{21} & Y_{22} & \dots & Y_{2n} \\ \dots & \dots & \dots & \dots \\ Y_{n1} & Y_{n2} & \dots & Y_{nn} \end{bmatrix} \begin{bmatrix} \Delta V_1 \\ \Delta V_2 \\ \dots \\ \Delta V_n \end{bmatrix}, \text{ and } \begin{bmatrix} \Delta V_1 \\ \Delta V_2 \\ \dots \\ \Delta V_3 \end{bmatrix} = \begin{bmatrix} Z_{11} & Z_{12} & \dots & Z_{1n} \\ Z_{21} & Z_{22} & \dots & Z_{2n} \\ \dots & \dots & \dots & \dots \\ Z_{n1} & Z_{n2} & \dots & Z_{nn} \end{bmatrix} \begin{bmatrix} \Delta I_1 \\ \Delta I_2 \\ \dots \\ \Delta I_n \end{bmatrix}$$

The Y bus matrix and the Z bus matrix are inverse matrices of each other. The elements of Z bus matrix reflects the voltage variations following changes in current injections at given buses. We can also write the real and

reactive power injection relationships, in linearized form, from the standard load flow equations as follows:

$$\begin{bmatrix} \Delta P \\ \Delta Q \end{bmatrix} = [J] \cdot \begin{bmatrix} \Delta \delta \\ \Delta V \end{bmatrix} = \begin{bmatrix} J_1 & J_2 \\ J_3 & J_4 \end{bmatrix} \cdot \begin{bmatrix} \Delta \delta \\ \Delta V \end{bmatrix} \quad (4.1)$$

Where $[J]$ is the Jacobian matrix and J_1, J_2, J_3 and J_4 are sub-matrices of J of appropriate dimensions, and are given in terms of the following partial differentials:

$$J = \begin{bmatrix} J_1 & J_2 \\ J_3 & J_4 \end{bmatrix} = \begin{bmatrix} \frac{\partial P}{\partial \delta} & \frac{\partial P}{\partial V} \\ \frac{\partial Q}{\partial \delta} & \frac{\partial Q}{\partial V} \end{bmatrix}$$

Neglecting the coupling between δ and reactive power, *i.e.*, $J_3=0$, the relationship between ΔQ and ΔV can be written from (4.1) as follows:

$$\Delta Q = J_4 \Delta V = \begin{bmatrix} \frac{\partial Q}{\partial V} \end{bmatrix} \cdot \Delta V \quad (4.2)$$

Or, we can write,

$$\Delta V = J_4^{-1} \Delta Q = \begin{bmatrix} \frac{\partial V}{\partial Q} \end{bmatrix} \cdot \Delta Q \quad (4.3)$$

The matrix $[\partial Q / \partial V]$ is a part of the Jacobian matrix J , while its inverse $[\partial V / \partial Q]$ is called the sensitivity matrix. Both matrices are real and non-symmetrical. The elements of $[\partial V / \partial Q]$ reflect the propagation of voltage variations following reactive power injections at given buses. The magnitude of voltage coupling between two buses can be quantified by the maximum attenuation of voltage variations between these two buses. These attenuations are easy to be obtained from the $[\partial V / \partial Q]$ matrix, by just dividing the elements of each column by the diagonal term. A matrix of attenuations between all the buses of the system, whose terms are written as α_{ij} is then available. We thus have,

$$\Delta V_i = \alpha_{ij} \Delta V_j \quad (4.4)$$

$$\text{where, } \alpha_{ij} = \left(\frac{\partial V_i}{\partial Q_j} \right) / \left(\frac{\partial V_j}{\partial Q_j} \right)$$

Generally, $\alpha_{ij} \neq \alpha_{ji}$. In order to have symmetric property in the electrical distance, the formulation below is used to define the electrical distance between two nodes i and j ,

$$D_{ij} = D_{ji} = -\text{Log}(\alpha_{ij} \cdot \alpha_{ji}) \quad (4.5)$$

Where, D_{ij} is the electrical distance between node i and j , and it has the properties of positivity and symmetry. This electrical distance can represent the degree of influences arising from voltage changes on other buses. The step by step method to obtain the separated voltage control areas is given below:

1. Calculate the Jacobian matrix J and hence obtain the sub-matrix J_4 , where $J_4 = [\partial Q / \partial V]$.
2. Inverse J_4 . Say, $B = \frac{\partial V}{\partial Q} = J_4^{-1}$, and the elements of matrix B are written as b_{ij} , where $b_{ij} = \partial V_i / \partial Q_j$.
3. Obtain attenuation matrix, α_{ij} , between all the nodes.
 $\alpha_{ij} = b_{ij} / b_{jj}$.
4. Calculate electrical distances D_{ij} .
 $D_{ij} = -\log(\alpha_{ij}, \alpha_{ji})$
5. Normalize the electrical distances as follows:
 $D_{ij} = D_{ij} / \text{Max}(D_{i1}, \dots, D_{iN})$

4.2 REACTIVE POWER MARKET FOR LOCAL VOLTAGE CONTROL AREAS

The reactive power market model to be presented here is an extension of the model discussed in Chapter-3. In this model, the reactive power market is settled for individual voltage control areas. All market participants submit their offers to the ISO in terms of the four components as discussed in Section-2.3.2. In the present model, we consider minimization of the payment function only, and not the loss and deviation functions. Therefore, we do not need the compromise objective any more. This does not affect the conclusions or observations in any way. But helps to reduce the computational burden involved in solving the compromise objective based

optimization problem. A new payment function is developed and discussed here, that obtain the uniform reactive power market prices for individual voltage control areas.

Suppose we have three voltage control areas, Zone A, Zone B and Zone C, with respective uniform market prices ρ_a , ρ_b and ρ_c , for each area. The subscripts “gena”, “genb” and “genc” denote the generators in Zone A, Zone B and Zone C, respectively. Thus, we can write the payment objective function based on zonal reactive power prices as follows:

$$\begin{aligned}
 J_{Payment} = & \sum_{gen} (\rho_0 \cdot W_{0,gen} - \rho_1 \cdot W_{1,gen} \cdot Q_{1,gen}) \\
 & + \sum_{gen,a} (\rho_{2a} \cdot W_{2,gena} \cdot Q_{2,gena} + \rho_{2a} \cdot W_{3,gena} \cdot Q_{A,gena} + \frac{1}{2} \rho_{3a} \cdot W_{3,gena} \cdot Q_{3,gena}^2) \\
 & + \sum_{gen,b} (\rho_{2b} \cdot W_{2,genb} \cdot Q_{2,genb} + \rho_{2b} \cdot W_{3,genb} \cdot Q_{A,genb} + \frac{1}{2} \rho_{3b} \cdot W_{3,genb} \cdot Q_{3,genb}^2) \\
 & + \sum_{gen,c} (\rho_{2c} \cdot W_{2,genc} \cdot Q_{2,genc} + \rho_{2c} \cdot W_{3,genc} \cdot Q_{A,genc} + \frac{1}{2} \rho_{3c} \cdot W_{3,genc} \cdot Q_{3,genc}^2)
 \end{aligned} \tag{4.6}$$

In (4.6), ρ_0 is the *uniform availability price* for the whole system; ρ_1 is the *uniform operating price* for absorbing reactive power; ρ_{2a} , ρ_{2b} and ρ_{2c} are the *uniform operating prices* for producing reactive power in zone A, zone B and zone C, respectively; ρ_{3a} , ρ_{3b} and ρ_{3c} are the *uniform opportunity prices* for zone A, zone B and zone C, respectively.

The constraints associated with the payment minimization problem are the same as that discussed in Chapter-3, except for the constraints of determining uniform market prices. The constraints are listed below.

- *Load Flow Equations (3.2), (3.3)*
- *Reactive Power Relational Constraints & Limits (3.4)-- (3.6)*
- *Reactive Power Generation Limits (3.12), (3.13)*
- *Bus Voltage Limits (3.14)*
- *Limit on Bilateral Transactions (3.15)*
- *Determining Uniform Market Prices (3.7), (3.8), (3.11) as well as the following constraints:*

$$(W_{2,i} + W_{3,i}) \cdot m_{2,i} \leq \rho_{2a}, \quad \forall i \in \text{Zone A} \quad (4.7)$$

$$(W_{2,i} + W_{3,i}) \cdot m_{2,i} \leq \rho_{2b}, \quad \forall i \in \text{Zone B} \quad (4.8)$$

$$(W_{2,i} + W_{3,i}) \cdot m_{2,i} \leq \rho_{2c}, \quad \forall i \in \text{Zone C} \quad (4.9)$$

$$W_{3,i} \cdot m_{3,i} \leq \rho_{3a}, \quad \forall i \in \text{Zone A} \quad (4.10)$$

$$W_{3,i} \cdot m_{3,i} \leq \rho_{3b}, \quad \forall i \in \text{Zone B} \quad (4.11)$$

$$W_{3,i} \cdot m_{3,i} \leq \rho_{3c}, \quad \forall i \in \text{Zone C} \quad (4.12)$$

4.3 CASE STUDY WITH CIGRÉ 32 BUS SYSTEM

The same Cigré 32-bus test system used in earlier chapters (refer Appendix-A) is used here to analyze the localized reactive power market proposed in this Chapter.

Following the five steps discussed in Section-4.1.1, the normalized electrical distances D_{ij} between generator buses “ i ” and all the buses “ j ” are calculated. To avoid analyzing too many electrical distance numbers between buses, we write a program in MATLAB to group the buses according to their distances D_{ij} (Table 4.1). In Table 4.1, columns 2, 3, 4 and 5 list the buses whose electrical distances with the generator buses of column 1 are within the range $D_{ij} \leq 0.10$, $0.10 < D_{ij} \leq 0.20$, $0.20 < D_{ij} \leq 0.25$ and $0.25 < D_{ij} \leq 0.30$, respectively.

Considering the electrical distances obtained in Table 4.1 and the topology structure of the network, the Cigré 32 bus system is divided into five Voltage Control Areas, zone-1 to zone-5, as shown in Figure 4.1. The electrical distances between the buses lying in different zones, are relatively further, compared to the distances between buses in same zone.

It is shown in Figure 4.1 that there are eight buses in zone-1, ten buses in zone-2, three buses in zone-3, eight buses in zone-4 and three buses in zone-5. Zone-3 and zone-5 are relatively small compare to other zones. And there are only two generators in zone-3 and one generator in zone-5, while both zone-1 and zone-2 have seven generators each. It is difficult to have a market in a zone that has too few generators. After examined the electrical distances between the buses in zone-3, zone-5 and buses in other zones, we found that zone-3 and zone-5 are closer to zone-4 than to other two zones. Thus we combine zone-3, zone-4 and zone-5 as one zone.

The new separation of voltage control areas is shown in Figure 4.2. In the new separation, we have Zone A, Zone B and Zone C.

Table 4.1. Electrical distances for grouping buses into voltage control areas

Generator Bus	The buses having electrical distances in the given range with the corresponding generator bus			
	$D_{ij} \leq 0.10$	$0.10 < D_{ij} \leq 0.20$	$0.20 < D_{ij} \leq 0.25$	$0.25 < D_{ij} \leq 0.30$
4072	4071		4012	1012
4071	4072	4012	1012	
4012	1012	4022	4071, 1014	4072, 1022
4021		4042, 4032	4031	4044
4031		4041, 4022, 4032, 2031		4021, 2032, 1022
4042		4021, 4032, 4043, 4044	4046, 1044	4031, 4045, 4047
4041		4031, 4061	4044	4062, 4032, 2031, 1044
4062	4063, 4061		4041, 4045	1045
4063	4062	4061		4041, 4045
4051		4045, 1045	4044	1041, 1044
4047	4046	4043	4042, 4044	1044
2032		2031	4031	
1013	1014	1011, 1012	4012	
1012	4012	1014	1013	4071, 4022
1014	1013	4012, 1012, 1011		
1022	4022	1021		4031
1021		1022	4022	
1043	1041	4044, 1044, 1045	1042, 4045	4043
1042		4044, 1044, 1045	1043, 1042, 4045	

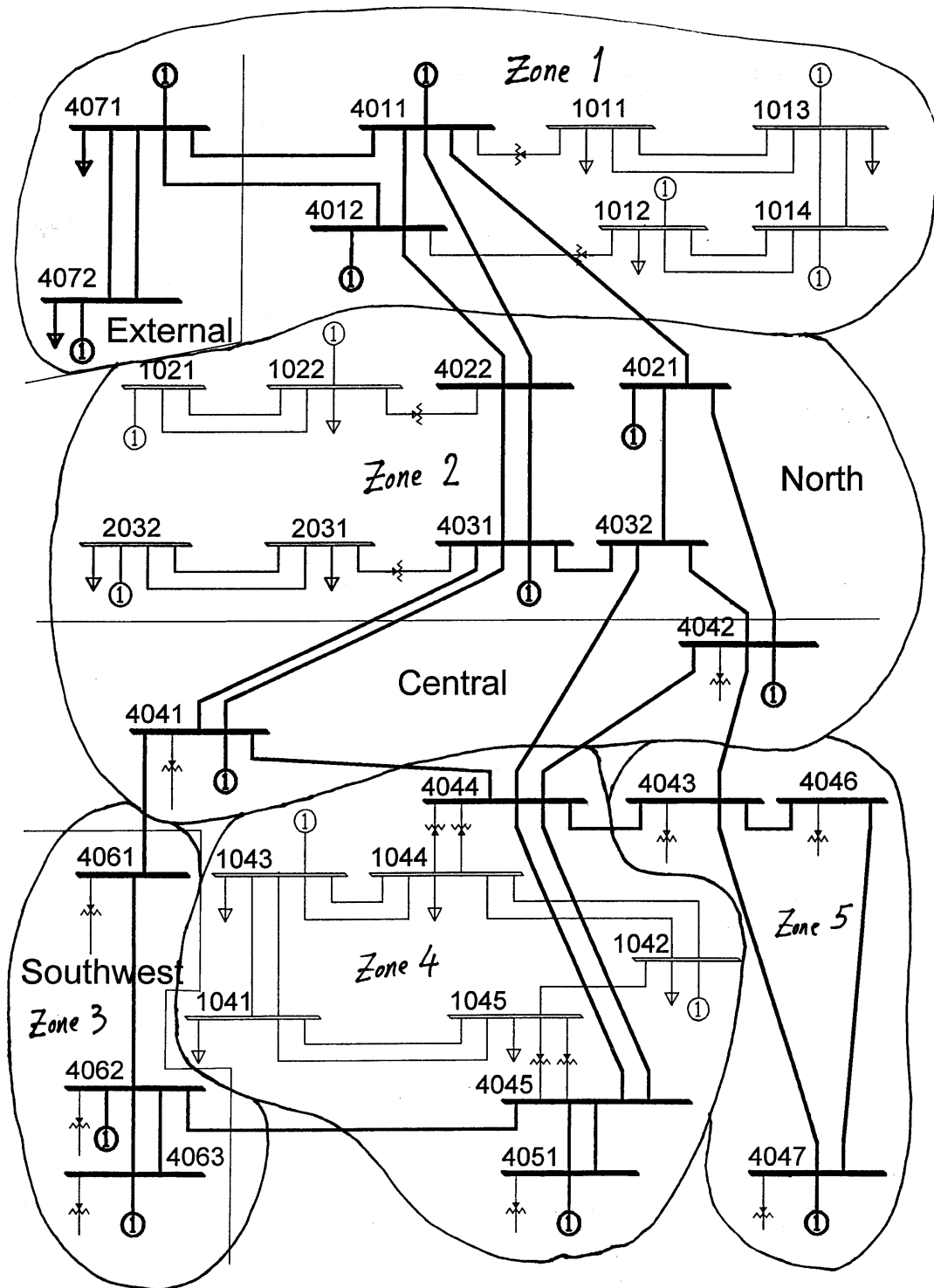

Figure 4.1. Cigré 32-bus System – Five Voltage Control Areas

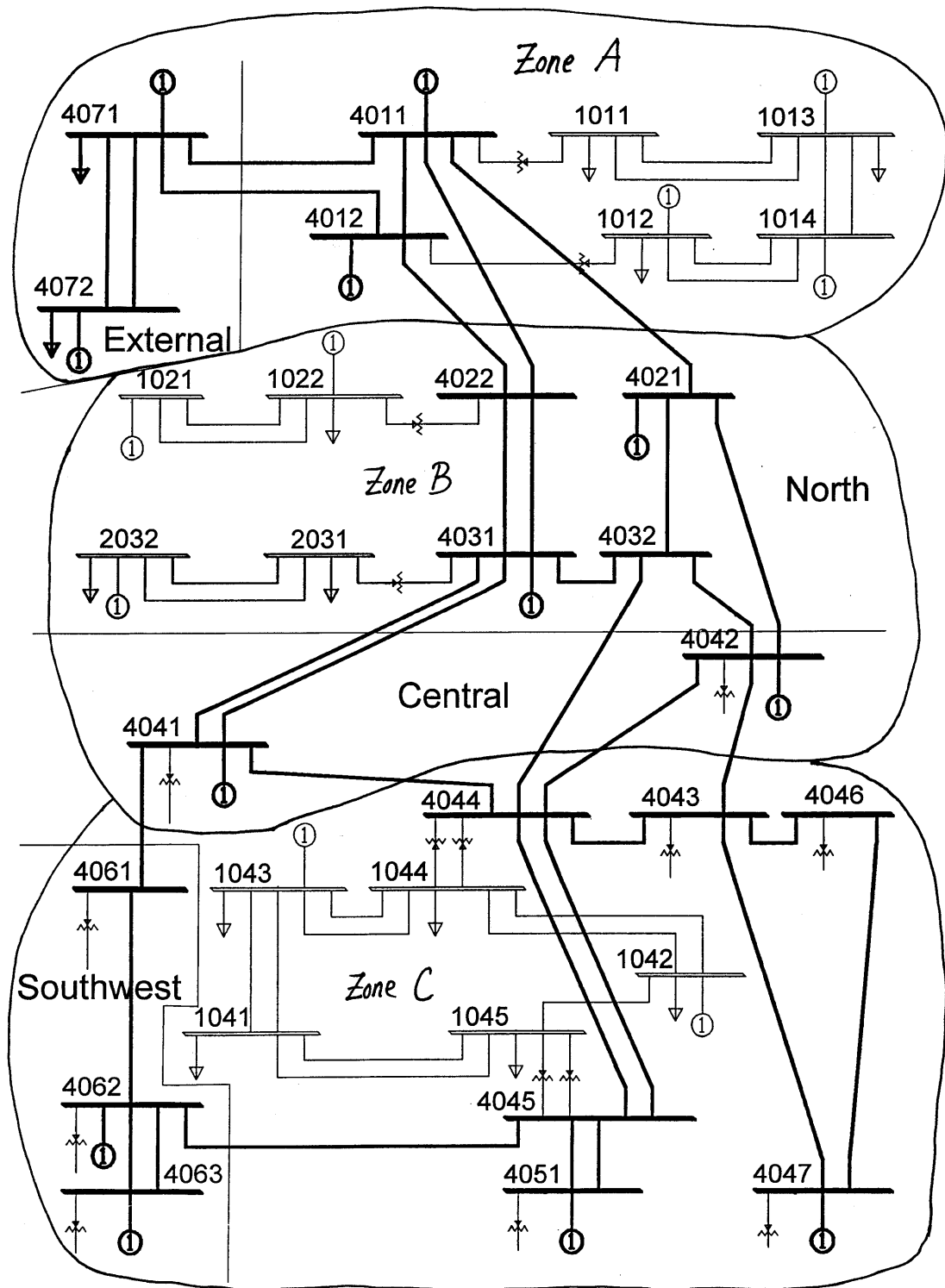

Figure 4.2. Cigré 32-bus System – Re-organization to Three Voltage Control Areas

Four study cases are now simulated to examine the proposed localized reactive power market.

- Case-0 simulates the reactive power market considering the whole system as one control area, and one set of uniform market prices for the whole system is obtained.
- Case-1 simulates the market considering three voltage control areas as that obtained earlier, and three sets of uniform market prices are obtained for the three areas, respectively.
- Both Case-0 and Case-1 use the same price offers from generators. By comparing the results of Case-0 and Case-1, we can see the advantages of considering voltage control areas for reactive power service price settlement.
- Case-2 and Case-3 simulates gaming scenarios over Case-1, wherein the service providers at bus 4072 offers 50% and 60% higher prices for its service.

Each provider offers four components, the availability offer a_0 , the cost of loss offer m_1 and m_2 , and opportunity offer m_3 as shown in the following tables. A uniform random number generator is used to simulate the four component offer prices, a_0 , m_1 , m_2 and m_3 .

4.3.1 Case-0: System as Whole

In Case-0, the market settlement scheme is run as discussed in Section-3.1. In this case, the uniform market prices ρ_0 , ρ_1 , ρ_2 and ρ_3 are obtained for the whole system. The purpose of calculating Case-0 in this chapter is to compare the results with Case-1, in which uniform market prices are obtained separately for three voltage control areas. The optimal reactive power contracts obtained for Case-0 are provided in Table 4.2.

In the following tables, the “*” denotes reactive power support contracted in the range of opportunity costs, and a bold underscored offer price, (e.g., **0.96**) denotes that the particular offer is the market price setting offer.

In this case, market prices are determined by the highest offer of the system. We get availability price $\rho_0=0.96$, operation price $\rho_2=1.12$, and opportunity price $\rho_3=0.25$. Generators “4072”, “2032” and “4011” are the corresponding price-setters. The under-excited operation price $\rho_1=0$.

Table 4.2. Case 0 – reactive power schemes and uniform prices for the whole system

Bus	Offer Prices (a_0, m_1, m_2, m_3)	Reactive Contracts in p.u.MVAr
4072	(0.96, 0.86, 0.86, 0.46)	6.61
4071	(0.40, 0.41, 0.41, 0.20)	0
4011	(0.77, 0.75, 0.75, 0.25)	3.77*
4012	(0.43, 0.41, 0.41, 0.19)	3.28*
1013	(0.50, 0.54, 0.54, 0.28)	1.25
1012	(0.42, 0.42, 0.42, 0.17)	0
1014	(0.69, 0.68, 0.68, 0.39)	1.66
4021	(0.91, 1.29, 1.29, 0.70)	0
4031	(0.85, 1.17, 1.17, 0.59)	0
4042	(0.90, 1.26, 1.26, 0.55)	0
4041	(0.73, 1.03, 1.03, 0.00)	0
1021	(0.65, 0.77, 0.77, 0.27)	0
1022	(0.88, 1.03, 1.03, 0.50)	0.61
2032	(0.73, 1.12, 1.12 , 0.40)	1.74
4062	(0.76, 1.05, 1.05, 0.48)	0
4063	(0.93, 1.16, 1.16, 0.52)	0
4051	(0.50, 0.76, 0.76, 0.33)	0
4047	(0.92, 1.11, 1.11, 0.71)	0
1043	(0.77, 0.90, 0.90, 0.48)	0
1042	(0.50, 0.65, 0.65, 0.34)	0
ISO's burden from these contracts		
Total Payment (J_p), \$		28.40
Available Price, ρ_0		0.96
Operation Price, ρ_1		0
Operation Price, ρ_2		1.12
Opportunity Price, ρ_3		0.25

4.3.2 Case-1: Considering Voltage Control Areas

The payment function (4.6), which calculates market prices for three zones, is used in the present case to minimize the payment. The optimal reactive power contracts and uniform market prices are provided in Table 4.3.

In this case, market prices are obtained for three zones. In each zone, market prices are determined from the highest accepted offer from the zone. From Table 4.3 we note the following:

- The generator “4072” is selected as price-setter of availability price for all zones, with the uniform availability price being $\rho_0=0.96$.

- No generator is selected to provide reactive power in zone C.
- The under-excited operation price ρ_1 is zero since we no generator is contracted to absorb reactive power.
- For zone A, $\rho_2=0.86$ and $\rho_3=0.19$; generators on buses “4072” and “4012” are the corresponding price-setters.
- For zone B, $\rho_2=1.12$ and $\rho_3=0.50$; generators on buses “2032” and “1022” are the corresponding price-setters.

By comparing the results of Table 4.2 and Table 4.3, we can have following observations:

- a. For zone A, the uniform market prices obtained in Case-0 are $\rho_2=1.12$ and $\rho_3=0.25$. These prices decrease to $\rho_2=0.86$ and $\rho_3=0.19$ in Case-1, when the market settlement is based on Voltage Control Areas .
- b. The payment in Case-0 is 28.40. It decreases to 23.77 in Case-1.

We can see that both market price and the total payment made by the ISO to procure reactive power service are reduced after we settle the market with respect to voltage control areas.

Table 4.3. Case 1 – reactive power schemes and uniform prices for three zones

	Bus	Offer Prices (a_0, m_1, m_2, m_3)	Reactive Contracts in p.u.MVAr
Zone A	4072	(0.96 , 0.86, 0.86 , 0.46)	6.82
	4071	(0.40, 0.41, 0.41, 0.20)	0
	4011	(0.77, 0.75, 0.75, 0.25)	2.52
	4012	(0.43, 0.41, 0.41, 0.19)	3.28*
	1013	(0.50, 0.54, 0.54, 0.28)	1.25
	1012	(0.42, 0.42, 0.42, 0.17)	2.78*
	1014	(0.69, 0.68, 0.68, 0.39)	0
Zone B	4021	(0.91, 1.29, 1.29, 0.70)	0
	4031	(0.85, 1.17, 1.17, 0.59)	0
	4042	(0.90, 1.26, 1.26, 0.55)	0
	4041	(0.73, 1.03, 1.03, 0.00)	0
	1021	(0.65, 0.77, 0.77, 0.27)	0
	1022	(0.88, 1.03, 1.03, 0.50)	0.91*
	2032	(0.73, 1.12, 1.12 , 0.40)	1.68
Zone C	4062	(0.76, 1.05, 1.05, 0.48)	0
	4063	(0.93, 1.16, 1.16, 0.52)	0
	4051	(0.50, 0.76, 0.76, 0.33)	0
	4047	(0.92, 1.11, 1.11, 0.71)	0
	1043	(0.77, 0.90, 0.90, 0.48)	0
	1042	(0.50, 0.65, 0.65, 0.34)	0
ISO's burden from these contracts			
Total Payment (J_p), \$			23.77
Zone			A B C
Available Price, ρ_0			0.96
Operation Price, ρ_1			0
Operation Price, ρ_2			0.86 1.12 0
Opportunity Price, ρ_3			0.19 0.50 0

4.3.3 Case-2 and Case-3: Gaming by Generator 4072

In Case-2 and Case-3, we increase the prices m_1 , m_2 and m_3 offered by the generator on bus 4072 by 50% and by 60% respective over the Case-0 and Case-1 prices. The reactive power schemes obtained when minimizing payment are provided in Table 4.4. In the table, the superscript 1, 2 or 3 denote that the particular offer is the market price setting offer obtained in Case-1, Case-2 or Case-3, respectively.

From Table 4.4, we can see that reactive power schemes are almost unchanged in Zone B and Zone C, when the offer prices of 4072, which is in

Zone A, are increased. In Zone A, the generator at bus 4071, which is the closest to 4072, is selected to provide reactive power when the offer prices of 4072 increase.

Table 4.4. Reactive power scheme comparison in three cases

	Bus	Offer Prices (a_0, m_1, m_2, m_3)		Reactive Power (p.u)		
				Case-1	Case-2	Case-3
Zone A	4072	Case-1	(0.96 ¹ , 0.86, 0.86 ¹ , 0.46)	6.82	5.62	5.61
		Case-2	(0.96 ² , 1.29, 1.29 ² , 0.70)			
		Case-3	(0.96 ³ , 1.38, 1.38 ³ , 0.74)			
	4071	(0.40, 0.41, 0.41, 0.20)		0	1.68*	1.68*
	4011	(0.77, 0.75, 0.75, 0.25 ^{2,3})		2.52	3.77*	3.77*
	4012	(0.43, 0.41, 0.41, 0.19 ¹)		3.28*	3.28*	3.28*
	1013	(0.50, 0.54, 0.54, 0.28)		1.25	0	0
	1012	(0.42, 0.42, 0.42, 0.17)		2.78*	0	0
	1014	(0.69, 0.68, 0.68, 0.39)		0	2.01	2.01
Zone B	4021	(0.91, 1.29, 1.29, 0.70)		0	0	0
	4031	(0.85, 1.17, 1.17, 0.59)		0	0	0
	4042	(0.90, 1.26, 1.26, 0.55)		0	0	0
	4041	(0.73, 1.03, 1.03, 0.00)		0	0	0
	1021	(0.65, 0.77, 0.77, 0.27)		0	0	0
	1022	(0.88, 1.03, 1.03, 0.50 ^{1,2,3})		0.91*	0.87*	0.87*
	2032	(0.73, 1.12, 1.12 ^{1,2,3} , 0.40)		1.68	1.61	1.64
Zone C	4062	(0.76, 1.05, 1.05, 0.48)		0	0	0
	4063	(0.93, 1.16, 1.16, 0.52)		0	0	0
	4051	(0.50, 0.76, 0.76, 0.33)		0	0	0
	4047	(0.92, 1.11, 1.11, 0.71)		0	0	0
	1043	(0.77, 0.90, 0.90, 0.48)		0	0	0
	1042	(0.50, 0.65, 0.65, 0.34)		0	0	0

The uniform market prices obtained in the three cases are compared in Table 4.5. We can see that the market prices of Zone B and Zone C retain the same even after a 60% increase in offer prices of 4072. This shows that gaming offers in one zone will not affect the market prices of other zones.

Table 4.5. Uniform market prices comparison in three cases

	Case-1			Case-2			Case-3		
	Zone A	Zone B	Zone C	Zone A	Zone B	Zone C	Zone A	Zone B	Zone C
Available Price, ρ_0	0.96			0.96			0.96		
Operation Price, ρ_1	0			0			0		
Operation Price, ρ_2	0.86	1.12	0	1.29	1.12	0	1.38	1.12	0
Opportunity Price, ρ_3	0.19	0.50	0	0.25	0.50	0	0.25	0.50	0

4.4 CONCLUDING REMARKS

The competitive market for reactive power services based on localized voltage control areas has been developed in this chapter. The market is based on four components of price offers from generators. The ISO settles the market for individual voltage control areas while minimizing the payment of the whole system.

The concept of electrical distance has been introduced. The concept has been used to separate out from the Cigré 32-bus system three voltage control areas. Reactive power market prices for three control areas are obtained by the ISO based on the offers. From the analysis of the results, we have following conclusions:

- Considering the reactive power market as localized at voltage control areas will reduce the payment burden of the ISO in procurement of reactive power services in the system.
- The prices of reactive power services in the areas with lower price offers are lower than the prices in the areas with higher price offers. This means that considering localized markets according to voltage control areas is more reasonable in deregulated system compared to considering one uniform price for the whole system.
- In the localized voltage control area based reactive power market, if a generator from one control area attempts to game the price, the market prices in other voltage control areas will not be affected.

CHAPTER 5

DESIGN OF COMPETITIVE MARKETS FOR SPINNING RESERVE SERVICES^{*}

5.1 SPINNING RESERVE SERVICES

In the context of power sector deregulation, secure operation of the power system is a challenging issue for the ISO which is faced with the difficult task of providing system security to various participants including providers and purchasers that is fair and equitable.

In pool type of markets, system security is often incorporated within the market settlement process. For example, in New York and PJM power pools, the ISO carries out a security constrained economic dispatch simulation based on energy price offers, start-up cost offers, and minimum and maximum generation levels [38]. In the case of PJM, the security constraints are subsequently input to a unit commitment model by the ISO to obtain generation and commitment schedules. In the context of New Zealand Electricity Market [39] also, various security constraints are simultaneously incorporated within the market clearing mechanism. The scheduling, pricing and dispatch model takes into account branch flow limits, generator ramp rates, fast acting reserves (6 seconds), sustained reserve (acting within 60 seconds), and various restrictions on clearance of spinning reserves and reserve capacity vis-à-vis the amount of power generation offers cleared.

In the New England Power Pool a 10-minute spinning reserve market is operated by the ISO [40]. All generators and dispatchable loads that are capable of providing such a service can submit offers. A ramp-rate constrained economic dispatch is performed to determine the desired dispatch points and real-time marginal prices ignoring reserve requirements.

^{*} Some parts of this chapter has been published in the following paper:

- J. Zhong and K. Bhattacharya, “Design of competitive markets for spinning reserve services,” Proceedings of IEEE Power Engineering Society Summer Meeting, Chicago, IL, July 2002, pp 1627-1632.

These economic dispatch results are used to simulate lost opportunity cost associated with resources that can potentially provide 10-minute spinning reserve.

Flynn *et al.* [41] proposed a method of generation scheduling in a competitive market that considers the reliability of the generating units. A gross pool structure is used to consider energy and ancillary services simultaneously. The optimization model determines the market settlement and provides the real power price and spinning reserve price, subject to various constraints. The level of reserve at each time period is determined by comparing the cost of supplying the reserve with the expected cost of not supplying it.

Similarly in [42] a market structure where generators offer their energy supply capabilities, ramp rates, and spinning reserve services while the ISO is responsible for both the market and system security has been developed. A method considering reliability and reserve in competitive generation scheduling is proposed. Augmented Lagrangian dual algorithm is used to formulate the problem, and reserve cost is included in the model. Generation ready-reserve capacity assessment is discussed in [43] and [44]. In [45], an on-line ready-reserve determination system is proposed. An artificial neural network using back-propagation learning rule is used to yield the amount of ready reserve.

Contrary to the pool where market settlement and system security have often been handled simultaneously, the bilateral contract dominated markets, such as those in the Nordic countries, have a disaggregated framework. The market settlement does not incorporate any security considerations. After the market is settled, the ISO incorporates available tools for security management and oversees that the trading schedules are fulfilled. These activities are outside the market settlement process and are usually managed through long-term contractual arrangements for spinning reserves and through short-term balance service markets.

While most of the work in spinning reserve scheduling or their market design has considered the problem aggregated within a market settlement process, we treat the issue independently. We propose the design of a spinning reserve service (SRS) market that functions in an isolated framework similar to the Nordic electricity market, where only system security and not market settlement is considered by the ISO.

5.2 DESIGN OF A SPINNING RESERVE SERVICE MARKET THAT IS INDEPENDENT OF THE ENERGY MARKET

As per NERC Operating Policy-10 [19] spinning reserve is the amount of generation made available to restore generation and demand balance in the system after a contingency has occurred. Some portion of the spinning reserve is frequency responsive in order to arrest frequency decline immediately after an outage.

The ISO or a similar authority usually evaluates the gross spinning reserve requirement for the system about a year in advance. Subsequently, the ISO is responsible on a day-to-day and hour-to-hour basis, to ensure that this reserve is available when required. The ISO procures this service from synchronized generating units that are able to respond within 10 minutes (in North America) or 15 minutes (in the Nordic) from the request while satisfying their ramp rates.

In this chapter, the design of a competitive market for spinning reserve service is proposed. The market works on the assumption that short-term contracts take place between the ISO and generators selected to provide the service. Uniform market price of spinning reserve service is derived from an auction model that incorporates both market and reserve constraints. The time frame of the working of the spinning reserve service market is shown in Figure 5.1.

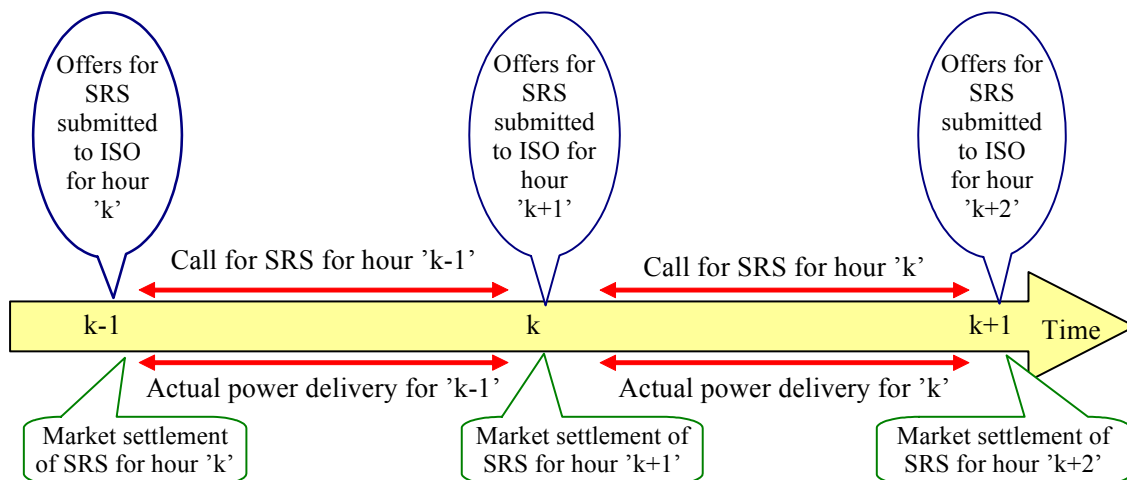

Figure 5.1. Time-frame of the functioning of the spinning reserve service market

It can be noted from Figure 5.1 that the generators submit their offers for the one hour period between $k-1$ and k at hour $k-1$, based on which, the spinning reserve service market is settled. The ISO procures a pool of

service providers, along with their cleared spinning reserve quantities, to call for in real-time between hour $k-1$ to k . This is repeated for the next hour and so on.

Each generating unit participating in the spinning reserve service market offers the ISO the quantity of spinning reserve, SR , (MW) that can be made available, and offer price β (\$/MWh) which indicates a generator's expectation of price per unit real power deviation from its scheduled operating point. It is to be noted that this scheduled operating point is known a priori to the generator and the ISO since the real-power market is already settled.

Once the ISO receives all the offers, the market is settled on first price, uniform auction that means, all selected generators receive a uniform price ρ (\$/MWh), which is the highest priced offer accepted. As discussed in [27], [28], this provides the generators enough incentives to bid their true costs.

The market price ρ is determined from the proposed model with the objective of minimizing total payment. The justification for selecting an objective function to minimize payment is that such a function seeks the lowest market price ρ from ISO's viewpoint of procurement of the service and is thus analogous to maximization of social welfare. The constraints in the model include those related to uniform price formulation, market structure and reserve requirement. The schematic diagram of the proposed spinning reserve service market is shown in Figure 5.2.

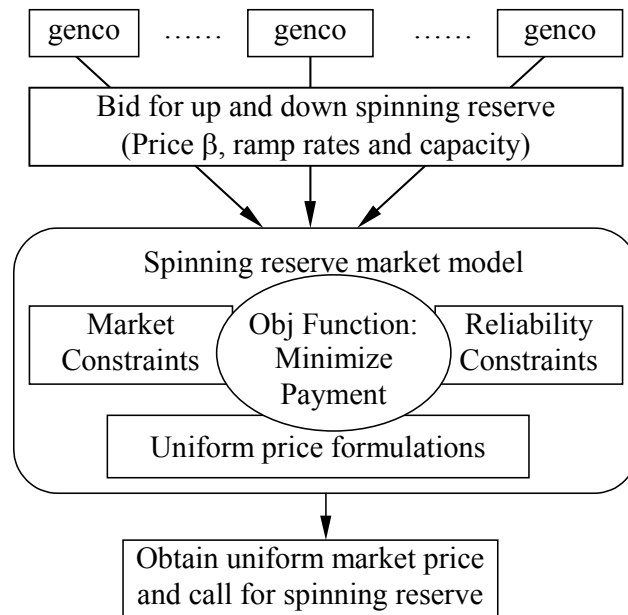

Figure 5.2. Proposed Structure of the Spinning Reserve Service Market

The main contributions of the proposed market model are the following:

- The spinning reserve service market is designed to operate at close to real-time and in parallel to the short-term real-power market. Thus generators will have enough scope to offer their capacities either to the real-power market or the spinning reserve market and thus have scope for fair competition.
- The spinning reserve service market is independent of the real-power market settlement and considers real power schedules given. Such a separation of the energy market and the ancillary service market provides scope to introduce and handle bilateral transactions easily.
- The spinning reserve service available to each generator takes into account a dynamic evaluation of the biddable capacity, to be discussed later.

5.3 SPINNING RESERVE SERVICE PROCUREMENT AND MARKET SETTLEMENT

As mentioned in Section-5.1, the proposed spinning reserve service market is an hour-ahead market. All generators submit their offers for next hour. The ISO contracts the selected generators to provide the service within their capacity limits in order to meet the system reserve requirement. The selection of appropriate generators is based on their offer prices and system load flow. For each hour, the offer price of the last selected unit determines the spinning reserve service market price for that hour.

5.3.1 Structure of Spinning Reserve Service Offers

In any system operation the ISO is expected to have information on the following parameters:

- Hourly demand at each bus, P_{Load}
- Maximum generation capacity of each generator, P_{MAX}
- Total amount of spinning reserve to be maintained in the system, TSR.

Given the above information, the ISO receives offers for spinning reserve service from all synchronized generators for the next hour. The offers are submitted on the following lines-

- Quantity of spinning reserve service offered, SR, in MW
- Offer price for providing spinning reserve service, β in \$/MWh

5.3.1.1 Quantity of Spinning Reserve Service Offered - Dynamic

Biddable Capacity

Since the market operates on a short-term basis, a generator can offer its service for the one-hour period between $k-1$ and k , depending on its actual generation $P_{GEN, Actual}$ at $k-1$ and the scheduled generation P_{GEN} at k , ramp-rate RAMP, and capacity P_{MAX} . Figure 5.3 shows the dynamic evaluation of the spinning reserve capacity for a generating unit that is biddable at any particular hour.

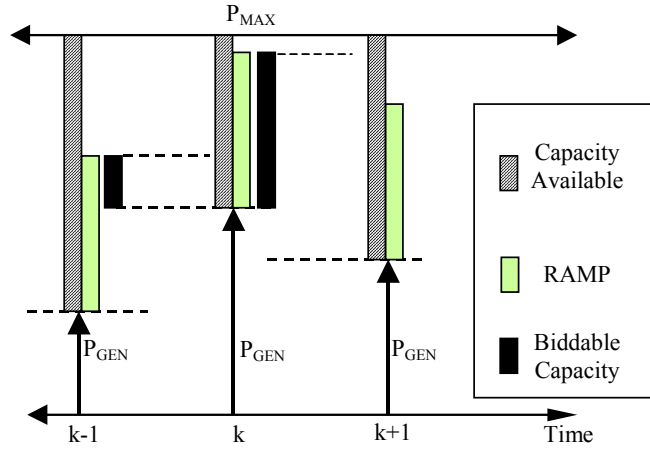

Figure 5.3. Dynamic Model for Evaluation of Biddable Spinning Reserve Capacity based on Generator Ramping Capability and Available Capacity

From Figure 5.3 we note the following:

- The 'black' strip at $k-1$ shows the biddable capacity at $k-1$ for one-hour period between $k-1$ and k . The biddable capacity is given by,

$$\mathfrak{R}_{i,k-1} = RAMP - (P_{GEN,k} - P_{GEN,k-1}) \quad (5.1)$$

- The 'black' strip at k denotes the biddable capacity at k for the one-hour period between k and $k+1$, and which now corresponds to RAMP.

$$\mathfrak{R}_{i,k} = RAMP - (P_{GEN,k+1} - P_{GEN,k}) \quad (5.2)$$

Since $P_{GEN,k+1}$ is less than $P_{GEN,k}$, the second component in (5.2) is negative and hence adds up with RAMP. Since inter-hour generation changes are limited by the ramp-rate, the biddable capacity in this case will be equal to RAMP.

Thus, to generalize, we can formulate a dynamic model of the biddable capacity as follows:

$$\mathfrak{R}_{i,k} = \min \left[\begin{array}{l} \min \left\{ RAMP_i, \left(RAMP_i - \left(P_{GEN_{i,k}} - P_{GEN,Actual_{i,k-1}} \right) \right) \right\} \\ \left\{ CAP_i - P_{GEN_{i,k}} \right\} \end{array} \right], \quad (5.3)$$

Once the upper limit on biddable capacity for a generator is thus calculated for an hour, a uniform random number generator is used to simulate the spinning reserve service capacity offers to the ISO, as follows:

$$SR_{i,k} = \text{uniform}(0, \mathfrak{R}_{i,k}) \quad (5.4)$$

It is to be noted that for hour k-1, $P_{GEN, Actual}$ is the same as scheduled value P_{GEN} since actual invocation of spinning reserve service by ISO is not considered. This work only discusses the procurement/contracting mechanism and market design for spinning reserve service. The relation for spinning reserve service biddable capacity in (5.3) is thus general enough to handle situations when generation changes from providing spinning reserve service can also be included.

5.3.2 Model Description

Objective Function:

The objective function considered for obtaining the market settlement, is minimization of ISO's total payments (5.5). As we have mentioned earlier, all contracted spinning reserve service providers will be paid the uniform market price ρ . Payment minimization would yield the lowest possible ρ and hence encourage participants to offer their true marginal costs.

$$J = \sum_g \left(P_{SRS_{g,k}} \times \rho \right) \quad (5.5)$$

Constraints:

Price determination:

The highest priced offer selected by the ISO from amongst the offers for spinning reserve service determines the uniform market price.

$$\rho_k \geq \beta_{g,k} \cdot W_{g,k} \quad (5.6)$$

W is an integer variable denoting selection of a particular offer from a generator g , at hour k .

$$\begin{cases} \text{generator 'g' is selected,} & W_{g,k} = 1 \\ \text{generator 'g' not selected} & W_{g,k} = 0 \end{cases}$$

Reserve constraints:

The ISO has to procure spinning reserves from the market so as to meet the stipulated requirements laid out by the policy-making regulator or such other body. For example, in the Nordic countries, Nordel (www.nordel.org) is responsible for evaluating such requirements on a fairly longer term basis, and the individual country ISOs are required to meet them during day-to-day operations.

$$\sum_g P_{SRS_{g,k}} \geq TSR_k \quad (5.7)$$

Spinning reserve selection limit

The amount of spinning reserve service cleared in the market will be limited by the biddable capacity SR.

$$0 \leq P_{SRS_{i,k}} \leq SR_{i,k} \quad (5.8)$$

As mentioned earlier, $SR_{i,k}$ is obtained from the dynamic model of biddable spinning reserve capacity, discussed earlier in Section-5.3.1.1 and given by (5.3) and (5.4).

5.4 CASE STUDY AND SCENARIO ANALYSES

The same Cigré 32-bus test system used in earlier chapters (refer Appendix-A) is used here to examine the proposed spinning reserve service market settlement and contracting scheme.

It is extremely difficult to develop a generalized model for individual generator's price offer for the spinning reserve service market. Price offers submitted by generators can depend on several factors such as system conditions, real-power market prices, information on system contingencies, and so on. Moreover, they can also depend on an individual generator's

choice of operating strategy. In this work we consider two models for generators' offer price strategies, as described in the following sub-sections.

5.4.1 Perfect Competition

In this price offer strategy, we assume that the prices offered by generators to the ISO for spinning reserve service represent their true cost of providing the service and is independent of system information. In particular, we model it as a constant function with respect to the total system reserves, given by (5.9) and as shown in Figure 5.4.



Figure 5.4. Offer prices in spinning reserve markets independent of system conditions

The offer prices can be represented as follows (Figure 5.4):

$$\beta_{i,k} = \beta_{o,i} \quad (5.9)$$

Once the price offers for generators are simulated using the above offer price strategy, the proposed spinning reserve service market settlement model is used to obtain the optimal spinning reserve contracting decisions by the ISO, as shown in Table 5.1. It can be seen that generator "4072" is selected by the ISO throughout all the 24-hours, while "4011" and "4063" are also the major providers of spinning reserve service in the market. One point to be noted here is that the ISO's objective is to maintain a pre-determined and mandatory fixed amount of spinning reserve in the system. However, because of the changing generation schedules of each generator, the spinning reserve service has to be contracted from different generators each hour, depending on their biddable capacity available and their respective offer prices.

Table 5.1. Generators contracted for spinning reserve services in the perfect market competition model

Time, hour	1	2	3	4	5	6	7	8	9	10	11	12	13	14	15	16	17	18	19	20	21	22	23	24	
4072	1	1	1	1	1	1	1	1	1	1	1	1	1	1	1	1	1	1	1	1	1	1	1	1	1
4011	-	-	-	-	1	-	1	1	1	1	1	1	1	1	1	1	1	1	1	-	1	-	1	1	
4012	-	-	-	-	-	-	-	-	-	-	-	-	1	-	-	-	-	1	-	-	-	-	-	-	-
4063	1	-	1	1	1	1	1	1	1	1	1	1	1	1	1	1	1	1	1	1	1	1	1	1	1
1014	-	-	-	-	-	-	1	1	1	-	-	1	1	-	-	1	1	-	-	1	-	-	1	-	1
1021	-	-	-	-	-	-	-	-	1	-	-	-	1	-	-	-	1	1	-	-	-	-	-	-	1

The price-setter generator at each hour is shown in **bold**.

Figure 5.5 shows the variation of system reserves over the day due to variations in system load. Also shown in Figure 5.5 is the spinning reserve service market price over the same day (*note that the axes are different*). It can be seen that the spinning reserve service market prices increase significantly, when system reserves are lower. During base-load hours when system reserves are in the order of 4000 MW, the spinning reserve service price is about 2\$/MWh. On the other hand, during peak hours, system reserve is about 1500 MW (and one unit outage can cause serious consequences to the system, the spinning reserve service market price is about 4.5\$/MWh.

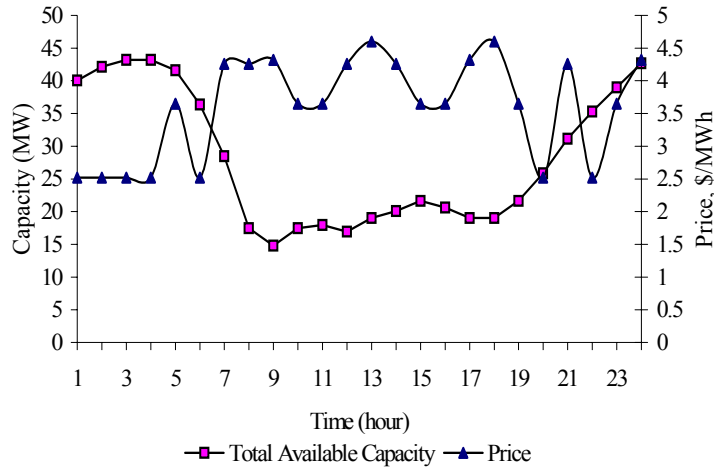

Figure 5.5. Behavior of SRS market price vis-à-vis available capacity in the system, under perfect competition without contingency

We now examine the spinning reserve service market when there is a sudden dip of 1200 MW in the total system capacity due to an outage of generator #4063. The outage takes place from hour 13 to hour 24. The spinning reserve service market is solved to obtain the new contract decisions (Table 5.2). We note that since "4063" is not available during hours 13-24, the ISO has to modify its contract with the generators in order

to meet the spinning reserve requirements, though it does not require to contract any new generator.

Table 5.2. Generators contracted for spinning reserve services in perfect market with outage of generator #4063 during hours 13-24

Time, hour	1	2	3	4	5	6	7	8	9	10	11	12	13	14	15	16	17	18	19	20	21	22	23	24	
4072	1	1	1	1	1	1	1	1	1	1	1	1	1	1	1	1	1	1	1	1	1	1	1	1	1
4011	-	-	-	-	1	-	1	1	1	1	1	1	1	1	1	1	1	1	1	-	1	-	1	1	1
4012	-	-	-	-	-	-	-	-	-	-	-	-	1	-	-	-	1	1	-	-	-	-	1	1	-
4063	1	-	1	1	1	1	1	1	1	1	1	1	-	-	-	-	-	-	-	-	-	-	-	-	-
1014	-	-	-	-	-	-	1	1	1	-	-	1	1	1	-	1	1	1	-	-	1	-	1	1	1
1021	-	-	-	-	-	-	-	-	1	-	-	-	1	-	-	-	1	1	-	-	1	-	1	1	1

The price-setter generator at each hour is shown in **bold**.

Figure 5.6 shows the hourly capacity available, without the outage and after the outage of generator "4063", and the corresponding spinning reserve service market prices respectively. Understandably the spinning reserve service market price increases during some of the hours, between hour 13-24, when more expensive offers are selected.

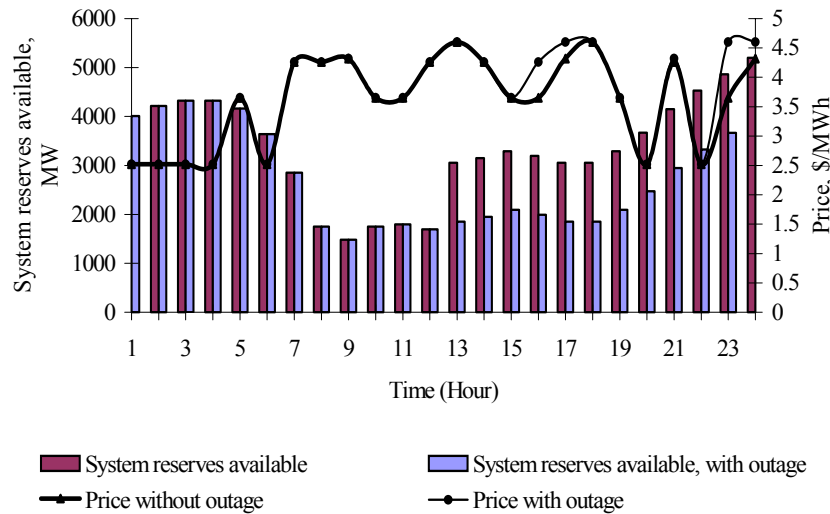

Figure 5.6. Comparison of capacity available with and without contingency and corresponding SRS market prices

5.4.2 Imperfect Competition

In this market model, the spinning reserve service offer prices submitted by generators are not expected to represent their true costs. In the present model we represent the offer prices by exponentially decaying function (5.10) of total system reserve (SRES). This in effect, is an imperfect competition model, though it is realistic enough since generators can be expected to have

such system information one hour ahead (they have this information in the Nordic system, put up on the ISO's web-sites). As can be noted from (5.10), when system reserve, SRES, tends to zero, the offer price approaches infinity, and when there is sufficient reserve, they approach the steady-state value of β_0 .

$$\beta_{i,k} = \frac{\beta_{o,i}}{(1 - e^{-SRES_k})} \quad (5.10)$$

Where $SRES_k = \frac{\sum_g P_{MAX_g} - \sum_i P_{LOAD_{i,k}}}{\sum_g P_{MAX_g}}$ is the total normalized system

reserve available at an hour. Figure 5.7 shows a typical plot of β as a function of SRES based on the function described in (5.10).

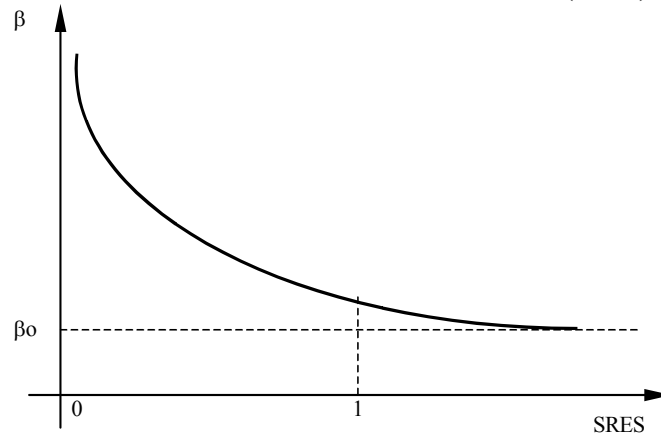

Figure 5.7. An imperfect market is constructed in this paper by modeling the SRS price offers from generators as exponentially decaying functions of total system reserve as shown in this figure.

Simulating the price offers for generators using the above model, the spinning reserve service market settlement is obtained and consequently the optimal spinning reserve contracts as shown in Table 5.3. Comparing Table 5.1 with Table 5.3, we find that there is very little change in the contracting decisions and only for a few hours, the decisions are different. This is not unexpected though, since we have considered all generators to be indulging in imperfect price offers simultaneously.

Table 5.3. Generators contracted for spinning reserve services in the imperfect market competition model

Time, hour	1	2	3	4	5	6	7	8	9	10	11	12	13	14	15	16	17	18	19	20	21	22	23	24	
4072	1	1	1	1	1	1	1	1	1	1	1	1	1	1	1	1	1	1	1	1	1	1	1	1	1
4011	-	-	-	-	1	-	1	1	1	1	1	1	1	1	1	1	1	1	1	-	1	-	1	1	
4012	-	-	-	-	-	-	-	-	-	-	-	-	1	-	-	-	-	1	-	-	-	-	-	-	-
4063	1	-	1	-	1	1	1	1	1	1	1	1	1	1	1	1	1	1	1	-	1	1	1	1	
1014	-	-	-	-	-	-	1	1	1	-	-	1	1	1	-	-	1	1	-	-	1	-	-	1	
1021	-	-	-	-	-	-	-	-	1	-	-	-	1	-	-	-	1	1	-	-	-	-	-	-	1

The price-setter generator at each hour is shown in **bold**.

On the other hand, due to this simultaneous imperfect behavior of generators to offer prices according to (5.10), instead of their true costs, the spinning reserve service market price increases drastically compared to the perfect market. Figure 5.8 shows a comparison of spinning reserve service market prices under two different competition models. It can be observed that the imperfect competition model increases the market price several times, particularly during the high load periods.

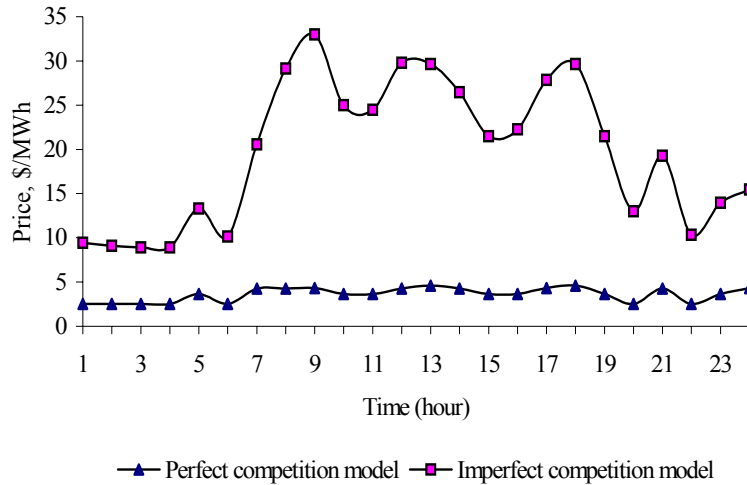

Figure 5.8. Comparison of prices in perfect and imperfect markets without contingency

Now we carry out the contingency study, as was carried out for the perfect market, by taking out generator "4063" during hours 13-24. It can be seen that the system reserves available reduces considerably and the market prices change for some hours, particularly those hours when the price setter changes (Figure 5.9).

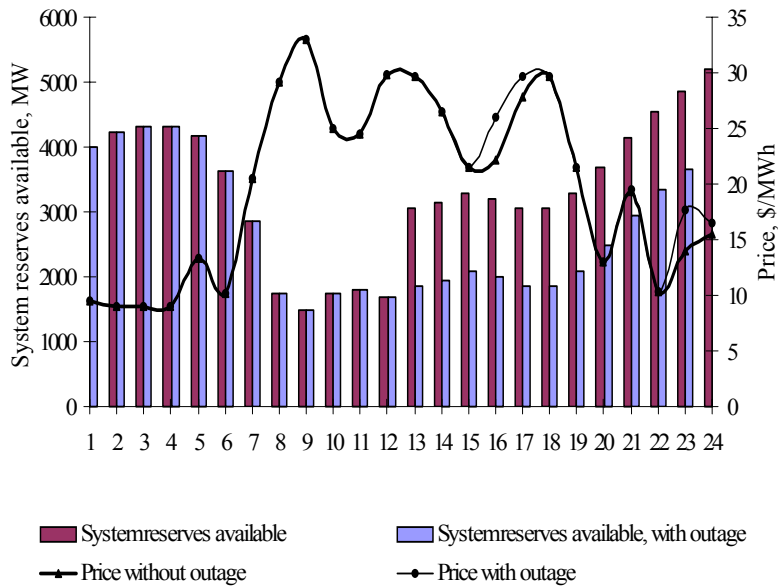

Figure 5.9. Comparison of SRS market price with and without contingency

Table 5.4 provides the contracting decisions by the ISO with regard to spinning reserve services in the imperfect competition environment.

Table 5.4. Generators contracted for spinning reserve services in the imperfect market competition model

Time, hour	1	2	3	4	5	6	7	8	9	10	11	12	13	14	15	16	17	18	19	20	21	22	23	24	
4072	1	1	1	1	1	1	1	1	1	1	1	1	1	1	1	1	1	1	1	1	1	1	1	1	1
4011	-	-	-	-	1	-	1	1	1	1	1	1	1	1	1	1	1	1	1	-	1	-	1	1	
4012	-	-	-	-	-	-	-	-	-	-	-	-	1	-	-	-	1	1	-	-	-	-	1	1	
4063	1	-	1	-	1	1	1	1	1	1	1	1	-	-	-	-	-	-	-	-	-	-	-	-	
1014	-	-	-	-	-	-	1	1	1	-	-	1	1	1	-	1	1	1	-	-	1	-	1	1	
1021	-	-	-	-	-	-	-	-	1	-	-	-	1	-	-	-	1	1	-	-	1	-	1	1	

The price-setter generator at each hour is shown in **bold**.

5.4.3 Spinning Reserve Market Price versus Available

Capacity Relationship

In order to investigate the relationship between the hourly spinning reserve service market price and the available capacity we carry out an econometric analysis, using the method of ordinary least squares (OLS) [46]. In the method, the hourly SRS market price is regressed over the capacity available, for both, the perfect competition model and the imperfect competition model. The econometric exercise indicates that available capacity is a highly significant variable in predicting the spinning reserve service market prices.

Table 5.5 provides the estimated coefficients for both competition models, considering a logarithmic estimation model. In the table, N denotes the number of observations (N=24 for 24 hours), CAPAVL is the hourly spinning capacity available, which is the net of committed capacity and scheduled generation; ρ denotes the SRS market price and t-statistics indicate the level of significance of the estimated coefficients. Any value of t-statistics greater than 2.6, in absolute terms, reflects that the coefficient is significant at 1% [46]. R^2 indicates how closely the estimated model fits the observed data.

From the obtained values of R^2 in Table 5.5, we see that CAPAVL explains up to about 41% of the variation in spinning reserve service market price variations in a perfect competition model. While, in an imperfect competition, CAPAVL is able to explain up to 84.5% of the variation in spinning reserve service market price. This also indicates that even in perfect markets, there would be some dependency of the spinning reserve service market price on CAPAVL and the market players would have every possibility to game unless the ISO takes care in removing market power from certain specific generators.

Table 5.5. Estimates of spinning reserve market price, $\ln(\rho)$

	Intercept (t-statistics)	$\ln(\text{CAPAVL})$ (t-statistics)	R^2	N
Perfect competition model	2.546*** (7.594)	-0.394*** (-3.86)	0.41	24
Imperfect competition model	6.55*** (19.45)	-1.12*** (-10.95)	0.845	24

*** Denotes significance at 1%

From the above analysis, we now develop the spinning reserve service price model for the two models of market competition since we note that CAPAVL is able to capture significantly the spinning reserve service price variations. We present the logarithmic model since it yields a better regression fit:

$$\text{Perfect Market - } \ln(\rho) = 2.546 - 0.394 \cdot \ln(\text{CAPAVL}) + \varepsilon \quad (5.11)$$

$$\text{Imperfect Market - } \ln(\rho) = 6.55 - 1.12 \cdot \ln(\text{CAPAVL}) + \varepsilon \quad (5.12)$$

From (5.11) we find that the price elasticity with respect to capacity available is -0.394 in a perfect market, which implies that for every 1 MW reduction in system capacity available, the spinning reserve service market price is estimated to increase by \$0.394. On the other hand, from (5.12) we

can interpret that if the market is imperfect, for every 1 MW reduction in system capacity available, the spinning reserve service market price is estimated to increase by \$1.12.

5.5 CONCLUDING REMARKS

This chapter presents the design of a spinning reserve market that operates on a close-to real time basis. The market for spinning reserve has been separated from the conventional energy market settlement. The ISO manages this market and procures spinning reserve services so as to minimize its payments towards these services. We incorporate bidding structures for the spinning reserve bids that are dependent on the system reserves. Two cases have been examined - a base case and a contingency case. It is found that the spinning reserve market price depends significantly on the system capacity available. Thereafter an econometric model has been constructed to determine the spinning reserve price versus system capacity relationship and a spinning reserve price model has been estimated.

CHAPTER 6

FREQUENCY REGULATION AS AN ANCILLARY SERVICE^{*}

6.1 INTRODUCTION

Frequency regulation is the control of the system frequency by maintaining a balance between generation and load on a minute-to-minute basis within a control area.

When a disturbance occurs in the system, there is a mismatch between the load and generation balance and the system frequency dips. The frequency dip results in an instantaneous increase in system generation, initiated by the governor responses. This is commonly known as governor regulation action or sometimes, *primary regulation*. The generation increase, taking place within a few seconds, combined with any frequency-dependent load reduction, helps arrest any further fall in frequency. Without any other control action, the system will stabilize and operate at a new steady-state frequency that is slightly less than nominal. This will, however, cause unscheduled power flows on the tie lines and lead to undesirable accumulation of area control error (ACE). To restore the system to nominal frequency, the generation set point of some units should be re-adjusted, based on the new generation-load balance. In many instances this is done

* Some parts of this chapter has been published in the following papers:

- J. Zhong, K. Bhattacharya and J. Daalder, "Design of ancillary service markets: Reactive power and frequency regulation," Proceedings of International Symposium on Bulk Power System Dynamics and Control, Onomichi City, Japan, August 2001, pp. 135-142.
- J. Zhong and K. Bhattacharya, "Automatic balance service for frequency regulation," presented at IEEE Power Engineering Society Transmission and Distribution Conference and Exposition, for student paper competition, Atlanta, GA, October 2001. (This paper received the First Prize in the Student Research Paper Competition).
- J. Zhong and K. Bhattacharya, "Frequency Linked Pricing as an Instrument for Frequency Regulation in Deregulated Electricity Markets", IEEE Power Engineering Society General Meeting, Toronto, Ontario Canada, July 13-17 (communicated).

through an automatic control action, known as the automatic generation control (AGC), while in some systems this is achieved through manual adjustment of the governor set-point, to balance the load. This control action, whether automatic or manual, is often referred to as *secondary regulation*.

In deregulated power systems the Independent System Operator (ISO) or the Transmission System Operator (TSO), as the case may be, provides system frequency control services in three broad ways:

- a primary regulation service from generating units that respond to frequency changes within a few seconds;
- a secondary regulation service from generating units that respond to signals from the ISO within 5 to 10 minutes; and
- a secondary regulation service from loads (customers) that respond to signals from the ISO within 5 to 10 minutes.

A detailed discussion of the potential system control problems and issues, associated with frequency control in deregulation, has been provided in [47],[48]. Two possible structures for load frequency control have been proposed therein, the ‘charged’ and the ‘bilateral’. In the first structure, the ISO would purchase real power from the providers (can be generators or customers) on a near-to real-time basis. This structure is already being practiced in some countries, the Scandinavian countries, for example. The later structure could be where the ISO has no obligation to provide frequency control and customers purchase load matching contracts from their energy provider directly. In [49] and [50] a framework for price-based operation of AGC in deregulated electricity markets has been developed. Bilateral contracts, poolco based transactions and area regulation contracts have been considered for AGC.

Most of the ISOs in the US and in the Union for the Co-ordination of Transmission of Electricity (UCTE) in Europe have an AGC system in place, for their secondary regulation. On the other hand, the Nordel and the UK systems, which are not part of UCTE, have opted for manual secondary control. The manual secondary control service is known as the *balance service* (or by similar names) since it continuously seeks to balance the system generation and consumption. The ISO of these respective countries accepts bids by volume (in MW) and price (\$/MWh) from generators willing to quickly (max 10 minutes) increase or decrease their generation, or even consumers willing to increase or decrease their consumption. The bids for regulation are arranged in price order to form a "staircase" for each

operating hour. When regulation is needed, the ISO activates the most profitable bid for regulating up or down.

At the end of each hour, the regulation price is determined in accordance with the most expensive measure taken during upward regulation (the purchase of balance energy), or the cheapest measure taken during downward regulation (the sell of balance energy), used during the hour. The final regulation price applies to all selected balance service providers [51], [52].

Although manual secondary control has so far performed satisfactorily in most systems, where it has been in use, there are apprehensions that in the increasingly competitive market environment with tighter operating regimes, the ISO could encounter situations when manual balancing does not perform as expected. Since these markets operate at very close to real-time, dominant providers in the balance service markets can have advantage of price setting and realize unrealistic profits. This can particularly be true when the system is at a critical operating point and reserve margins available to the ISO are low. These factors lead us to devise a secondary frequency control scheme that combines the existing balance service market within an AGC type mechanism that works on market price signals.

To this effect, in this chapter we develop a market framework for Automatic Balance Services (ABS), both for primary as well as secondary regulation. The market structure is based on the assumption that the balance providers automatically respond to price signals sent by the ISO, when there is a frequency excursion in the system. These price signals are frequency dependent. Subsequently, optimization models are proposed to obtain the market clearing prices for the individual regulation services. Finally, the optimum frequency regulation contracts are incorporated within a dynamic simulation model of a two control-area system, each area having multiple balance service providers (both generators and loads), to demonstrate the effectiveness of the proposed scheme.

Real-time frequency-linked price signals have been used earlier and have been shown to achieve improved frequency regulation and control performances [53], [54]. Berger and Schweppe [53] demonstrated that real-time pricing in the presence of system dynamics could aid in load-frequency control. In [54] a pricing scheme was suggested that gives the importing area a signal in terms of increased price for any increment in power drawn, from scheduled value. The increase in price is viewed as a penalty that

discourages deviation from the scheduled power flow and thereby ensures grid discipline.

6.2 DESIGN OF A FREQUENCY REGULATION MARKET

The proposed frequency regulation market structure is similar to a power pool where all service providers submit their bid-offers. The bid offers can be for, both primary and secondary regulation services. A notable aspect of the bid offers is the linkage of price and quantity offers with the frequency.

The combined frequency regulation service market operates in two stages. In the first stage the market prices for primary and secondary regulation service is determined by the ISO based on bids obtained. The second stage is the real-time activation of the services by the ISO based on signals derived from system frequency deviation. The combined framework of the frequency regulation service scheme is shown in Figure 6.1.

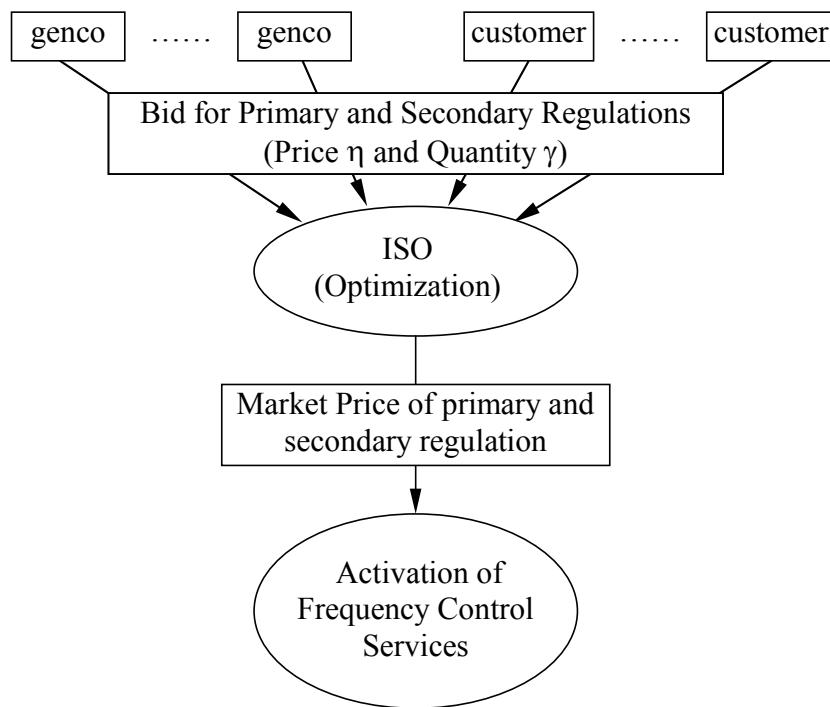

Figure 6.1 Framework of the Primary and Secondary Market

6.2.1 Primary Regulation

The proposed scheme considers that $\gamma_{PR,i}$ is the quantity per unit market price of primary frequency regulation offered by a genco 'i'. Similarly, $\eta_{PR,i}$ is the price per unit of frequency deviation, offered by the genco 'i' (Table 6.1). Say, if unit-1 offers to increase its generation by 1.95% for a 1% increase in price, and assuming a market price of \$150/MWh, we have,

$$\gamma_1 = \frac{1.95\% \text{ p.u.MW}}{150\$ / MWh \cdot 1\%} = 0.013 \frac{\text{p.u.MW}}{\$ / MWh}$$

This means that a genco bidding $\gamma_1=0.013\text{p.u MW}/\$/\text{MWh}$ is offering 0.013p.u.MW per unit price change.

Table 6.1 Frequency-linked bid offers for primary regulation

	From gencos		From Customers	
	Quantity	Price	Quantity	Price
Primary Regulation	$\gamma_{PR,i}$ p.u.MW/(\$/MWh)	$\eta_{PR,i}$ (\$/MWh-Hz)	--	--

The market is settled based on the price and quantity offers from all gencos, as discussed in the optimization model later. The ISO determines the primary regulation market price P_{PR} , specified in per unit of frequency excursion, from the generators' bid price parameters $\gamma_{PR,i}$ and $\eta_{PR,i}$ ($i=1, \dots, n$) as well as their location in the system. The contracted gencos receive the market price P_{PR} . Primary regulation services are activated by P_{PR} that is sent when there is a frequency excursion in the system. The generating units contracting this service are prepared to increase or reduce their generation instantaneously as per the following relation:

$$\Delta P_{gi} = -P_{PR} \cdot \gamma_{PR,i} \cdot \Delta f_{area} \quad (6.1)$$

A dynamic model demonstrating how gencos would participate and respond to the ISO's frequency-linked price signal, for primary frequency control within a control area, is shown in Figure 6.2. As seen, each contracted genco is available to provide $\gamma_{PR,i}$ amount of primary control service which is activated by the primary frequency regulation market price signal P_{PR} .

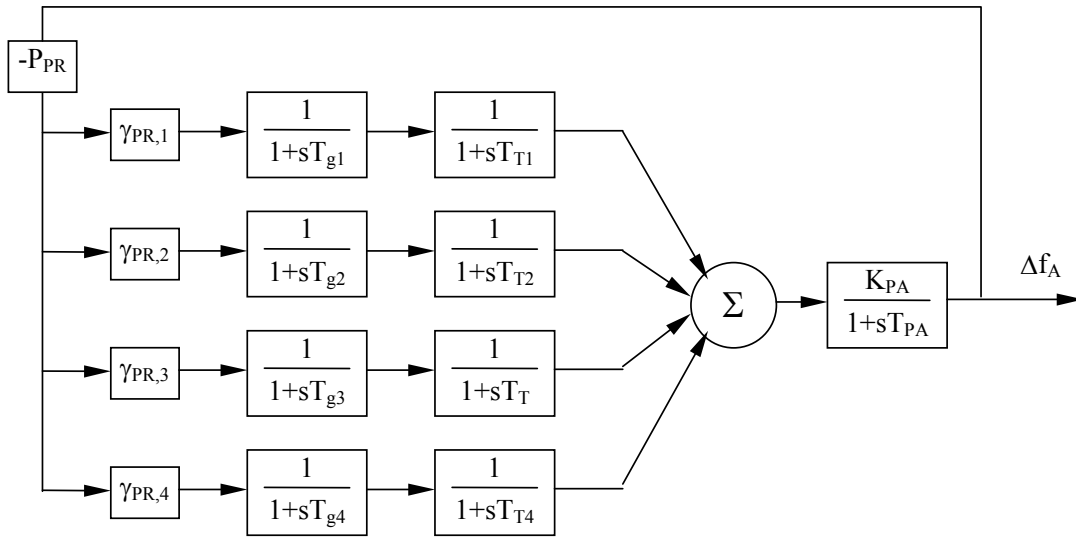

Figure 6.2 Dynamic Model of Primary Control of Frequency within a Contract Area, A, from Contracted Gencos

6.2.1.1 Settlement of Primary Regulation Service Market

Each genco contracting for primary regulation provides the ISO a bid price $\eta_{PR,i}$ and a bid quantity $\gamma_{PR,i}$. Once the ISO receives all the bids, it determines a uniform market price, P_{PR} . It is assumed that the ISO has information on the location from which a bid offer will be met by the provider. This will enable taking into account the system loss factors at different nodes, which are dependent on load and generation pattern of the system. Loss factors are then incorporated in the submitted bids since a frequency regulation service by a remotely located genco could lead to increased losses in the network. All the bids are then arranged in ascending order of their (revised) prices and when the sum of the offered quantity satisfies the regulation requirement, the market price is obtained (Figure 6.3). P_{PR} is the price that all contracted gencos, providing the primary frequency regulation service, will receive.

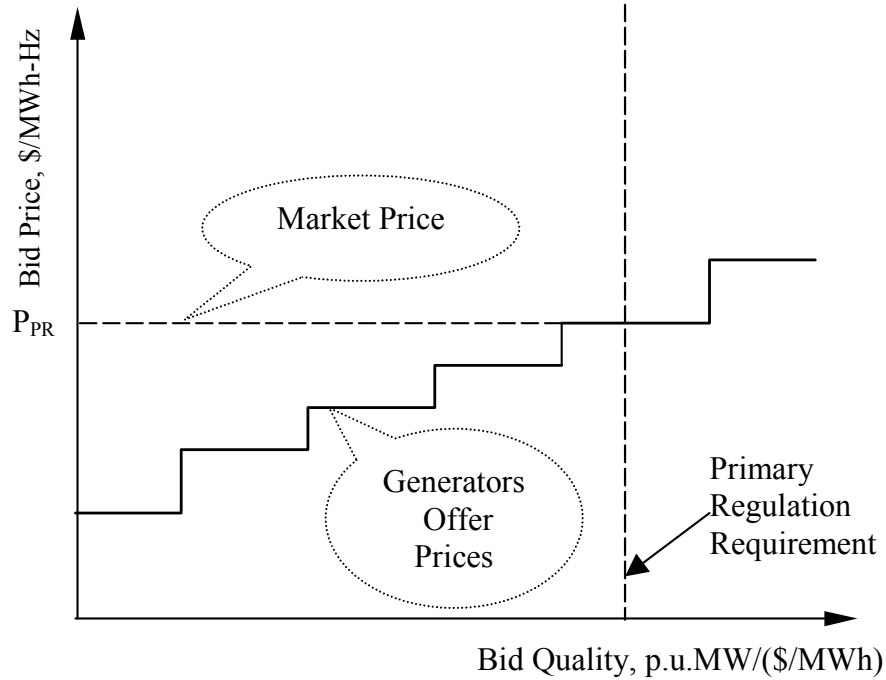

Figure 6.3 Primary Regulation Market Settlement (Note that the price offers are modified with respective loss factors that are determined a priori by the ISO.)

The optimization model to determine the primary regulation market price can be formulated as follows:

Objective Function: Minimize Payment for Primary Regulation Service

$$\text{Minimize } PR_{obj} = \sum_i U_{PR,i} \cdot \gamma_{PR,i} \cdot P_{PR} \quad (6.2)$$

Constraints:

$$\sum_i U_{PR,i} \cdot \gamma_{PR,i} \cdot LF_{PR,i} \geq D_{PR} \quad (6.3)$$

$$U_{PR,i} \cdot \gamma_{PR,i} \leq P_{PR} \quad \forall i \in n \quad (6.4)$$

$$U_{PR,i} = \begin{cases} 1 & \text{bid offer of generator } i \text{ selected} \\ 0 & \text{bid offer of generator } i \text{ not selected} \end{cases}$$

$U_{PR,i}$ is a binary variable associated with the selection of a particular bid offer for primary regulation.

6.2.2 Secondary Regulation

These services are contracted in order to restore the system frequency to nominal (say 50 Hz) after a disturbance. This can be achieved either by increasing/reducing an area's total generation or by reducing / increasing an area's total demand. The secondary regulation market design includes bids from customers also, in addition to those from gencos. The market is settled in the same way as that for the primary regulation market. Table 6.2 shows the proposed structure of bid price and quantity for the participants of the secondary-up and -down regulation market. The secondary regulation bid η_{SR} is the price per unit of energy while γ_{SR} is the quantity offered per unit of price.

Table 6.2 Bid offers for secondary regulation

	From gencos		From Customers	
	Quantity	Price	Quantity	Price
Secondary Up Regulation	$\gamma_{SR,i}^{UP}$ (p.u.MW/(\$/MWh))	$\eta_{SR,i}^{UP}$ ((\$/MWh)/MWh)	$\gamma_{SR,i}^{UP}$ (p.u.MW/(\$/MWh))	$\eta_{SR,i}^{UP}$ ((\$/MWh)/MWh)
Secondary Down Regulation	$\gamma_{SR,i}^{DN}$ (p.u.MW/(\$/MWh))	$\eta_{SR,i}^{DN}$ ((\$/MWh)/MWh)	$\gamma_{SR,i}^{DN}$ (p.u.MW/(\$/MWh))	$\eta_{SR,i}^{DN}$ ((\$/MWh)/MWh)

Secondary Regulation Service from Generators: We first consider the case of gencos contracting for secondary regulation services. The contracted gencos respond to the price-linked signal sent out by the ISO according to their response rates depending on their technical characteristic or on economical criteria. Frequency control in this case can be achieved by controlling generation in an area through a real-time secondary regulation. The price-linked control signal is of the form:

$$\Delta\rho(t) = -P_{SR,area} \int ACE_{area}(t) dt \quad (6.5)$$

P_{SR} is the area's secondary regulation price that is obtained from the market settlement model, to be discussed next. The generators contracted to respond to the control signal increase or decrease their generation as per the following relation:

$$\Delta P_{gi} = \gamma_{SR,i} \cdot \Delta\rho \quad (6.6)$$

Secondary Regulation Service from Customers: In this case, the contracted customers respond to the price-linked control signal sent by the ISO by increasing or reducing their demand, according to their response rates that may depend on their load characteristic or economical criteria. The price-linked signal is the same, as described by (6.5). The loads contracted to

respond to this signal, increase or decrease their load as per the following relation:

$$\Delta P_{di} = -\gamma_{SR,Di} \cdot \Delta \rho \quad (6.7)$$

6.2.2.1 Settlement of Secondary Regulation Service Market

Generators and customers can both provide the regulation bid, quantity $\gamma_{SR,i}^{UP}$ at price $\eta_{SR,i}^{UP}$ for up-regulation, and $\gamma_{SR,i}^{DN}$ at price $\eta_{SR,i}^{DN}$ for down-regulation. After receiving the bid information, the ISO determines the up-regulation market price P_{SR}^{UP} and the down-regulation market price P_{SR}^{DN} , such that the payment for secondary regulation service is minimal and the social welfare is maximized. In this case also, the loss factors associated with the location of each bid are taken into account within the optimization framework.

All up-regulation bids are arranged in ascending order and all down-regulation bids are arranged in descending order using the real-power spot price as the reference point (Figure 6.4). P_{SR}^{UP} and P_{SR}^{DN} are decided by the ISO on the short-term (hour to hour), based on the requirements of secondary regulation by the system.

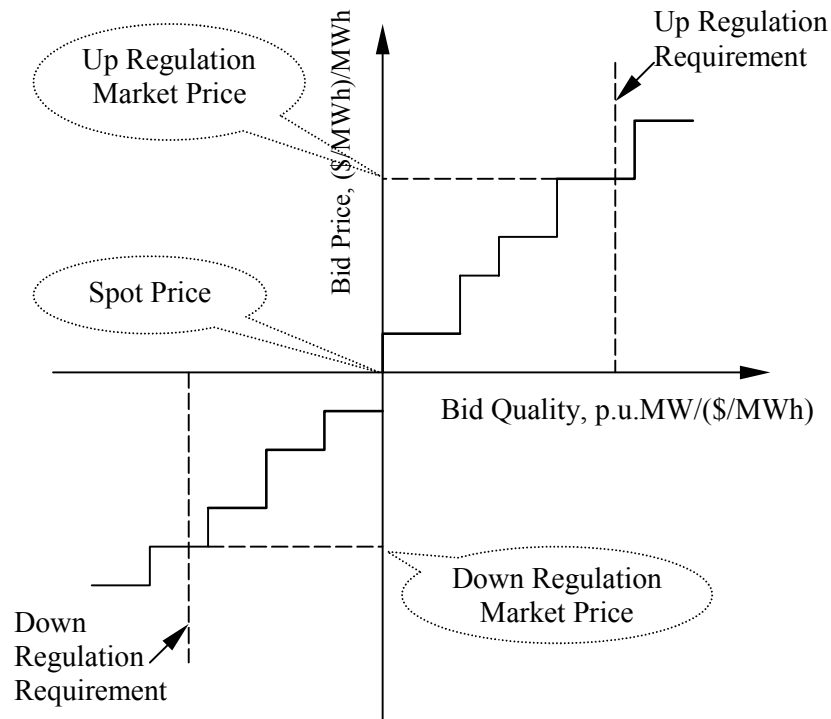

Figure 6.4 Secondary Regulation Service Bid Curve

The market settlement is obtained from an optimization model that seeks the secondary (up or down) regulation market prices, based on generators' bids.

Objective Function: Minimize Payment for Secondary Regulation Service

$$\text{Minimize } SRObj = \sum_i U_{SR,i}^{UP} \cdot \gamma_{SR,i}^{UP} \cdot P_{SR}^{UP} + \sum_i U_{SR,i}^{DN} \cdot \gamma_{SR,i}^{DN} \cdot P_{SR}^{DN} \quad (6.8)$$

Constraints:

$$\sum_i U_{SR,i}^{UP} \cdot \gamma_{SR,i}^{UP} \cdot LF_{SR,i} \geq D_{SR}^{UP} \quad (6.9)$$

$$U_{SR,i}^{UP} \cdot \gamma_{SR,i}^{UP} \leq P_{SR}^{UP} \quad \forall i \in n \quad (6.10)$$

$$\sum_i U_{SR,i}^{DN} \cdot \gamma_{SR,i}^{DN} \cdot LF_{SR,i} \leq D_{SR}^{DN} \quad (6.11)$$

$$U_{SR,i}^{DN} \cdot \gamma_{SR,i}^{DN} \geq P_{SR}^{DN} \quad \forall i \in n \quad (6.12)$$

$$U_{SR,i} = \begin{cases} 1 & \text{bid offer of generator } i \text{ selected} \\ 0 & \text{bid offer of generator } i \text{ not selected} \end{cases}$$

$U_{SR,i}^{UP}$ and $U_{SR,i}^{DN}$ are binary variables associated with the selection of a bid for secondary regulation services.

6.3 CASE STUDY

A two-area interconnected power system is now considered to examine the proposed market dynamics and the performance of frequency-linked prices on regulation services. We assume that the frequency regulation service providers provide their regulation service to their respective area's ISO only. Figure 6.5 shows the dynamic model of a two-area interconnected power system with the proposed primary and secondary control mechanisms.

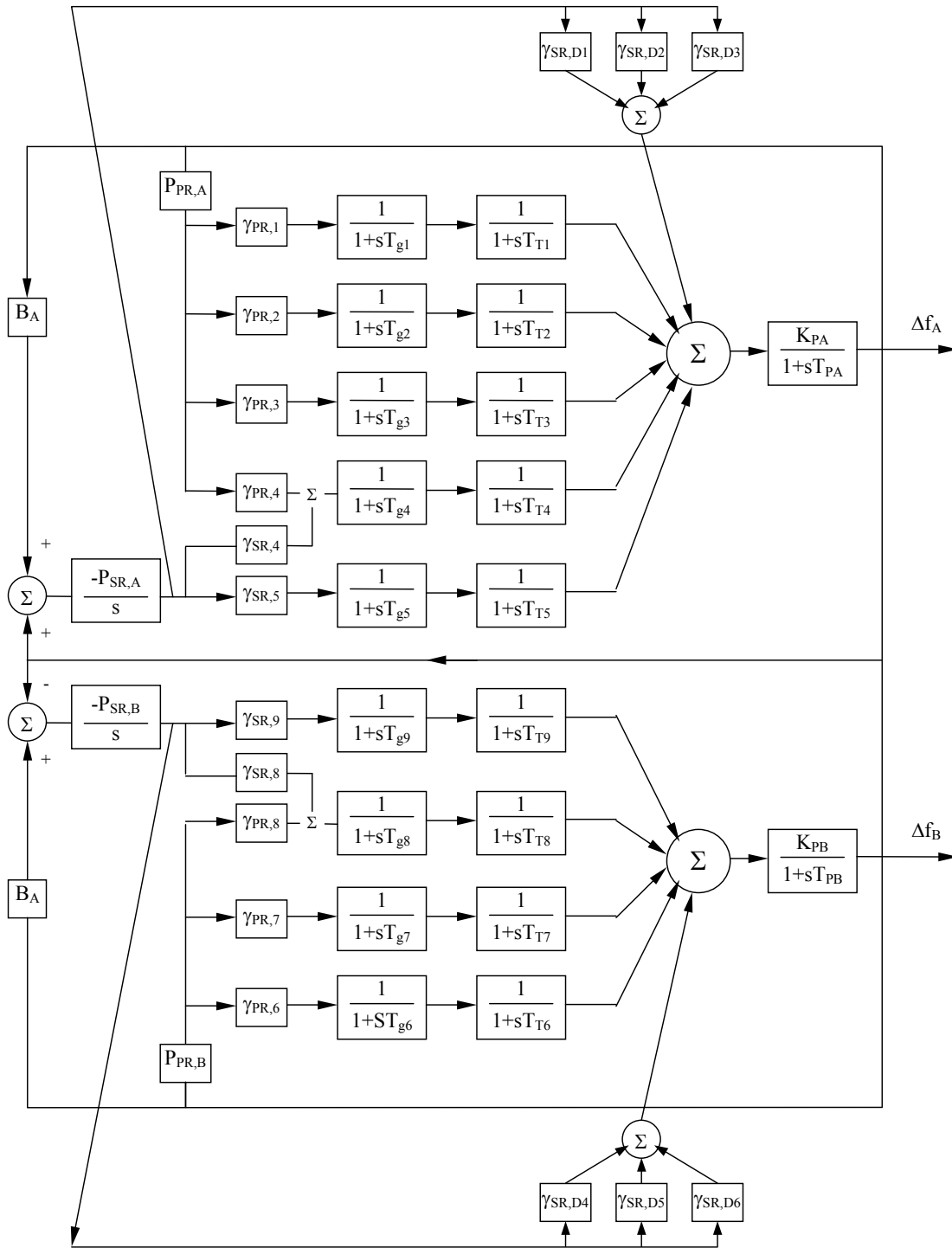

Figure 6.5 Dynamic Model of Primary and Secondary Control

6.3.1 Primary Regulation

In Area-A, we assume that there are 10 generators willing to provide the primary regulation service. Their corresponding bid offers, $\eta_{PR,i}$ and $\gamma_{PR,i}$, and those selected by the ISO, are shown in Table 6.3.

Table 6.3 Primary regulation bid in Area-A

Provider i	<u>1</u>	2	3	4	<u>5</u>	<u>6</u>	7	8	<u>9</u>	10
$\eta_{PR,i}$ (\$/MWh-Hz)	<u>0.23</u>	0.37	0.31	0.26	<u>0.26</u>	<u>0.24</u>	0.27	0.37	<u>0.21</u>	0.30
$\gamma_{PR,i}$ p.u.MW/(\$/MWh)	<u>0.10</u>	0.11	0.27	0.36	<u>0.42</u>	<u>0.14</u>	0.18	0.10	<u>0.19</u>	0.17
Loss Factor	<u>0.96</u>	0.96	0.98	0.95	<u>0.96</u>	<u>0.95</u>	0.96	0.97	<u>0.96</u>	0.96

(The selected offers are underlined)

The primary regulation service providers are selected based on the optimization model discussed in Section-6.2.1. The primary regulation market price is 0.26 \$/MWh-Hz and the total primary regulation energy cleared in the market is 0.8 p.u.MW.

In Area-B, we assume that there are 8 generators willing to provide the primary regulation service. The primary regulation bid offers, $\eta_{PR,i}$ and $\gamma_{PR,i}$, and those selected by the ISO, are shown in Table 6.4.

Table 6.4 Primary regulation bid in Area-B

Provider i	<u>1</u>	2	3	<u>4</u>	5	<u>6</u>	7	8
$\eta_{PR,i}$ (\$/MWh-Hz)	<u>0.23</u>	0.37	0.31	<u>0.26</u>	0.26	<u>0.24</u>	0.27	0.37
$\gamma_{PR,i}$ p.u.MW/(\$/MWh)	<u>0.08</u>	0.27	0.30	<u>0.13</u>	0.10	<u>0.20</u>	0.10	0.11
Loss Factor	<u>0.95</u>	0.95	0.98	<u>0.97</u>	0.95	<u>0.98</u>	0.95	0.96

(The selected offers are underlined)

6.3.2 Secondary Regulation

Now we consider 11 providers, comprising 6 generators and 5 customers willing to provide the secondary regulation services in Area-A. The secondary up and down bid prices $\eta_{SR,i}^{UP}$ and $\eta_{SR,i}^{DN}$ and the respective bid quantities $\gamma_{SR,i}^{UP}$ and $\gamma_{SR,i}^{DN}$, and those bids selected by the ISO are shown in Table 6.5.

Table 6.5 Secondary regulation bid in Area-A

Up Regulation	From Generators						From Customers				
Provider i	1	2	3	4	<u>5</u>	6	<u>7</u>	<u>8</u>	9	10	<u>11</u>
$\eta_{SR,i}^{UP}$ (\$/MWh)/MWh	0.40	0.32	0.40	0.35	<u>0.23</u>	0.33	<u>0.23</u>	<u>0.25</u>	0.33	0.29	<u>0.27</u>
$\gamma_{SR,i}^{UP}$ p.u.MW/(\$/MWh)	0.01	0.01	0.04	0.03	<u>0.03</u>	0.01	<u>0.03</u>	<u>0.03</u>	0.03	0.01	<u>0.04</u>
Loss Factor	0.98	0.95	0.97	0.95	<u>0.95</u>	0.97	<u>0.97</u>	<u>0.98</u>	0.96	0.97	<u>0.96</u>
Down Regulation	From Generators						From Customers				
Provider i	1	2	3	4	<u>5</u>	6	7	<u>8</u>	9	10	<u>11</u>
$\eta_{SR,i}^{DN}$ ((\$/MWh)/MWh)	0.07	0.03	0.03	<u>0.12</u>	<u>0.17</u>	0.05	0.13	<u>0.16</u>	0.06	0.02	<u>0.10</u>
$\gamma_{SR,i}^{DN}$ p.u.MW/(\$/MWh)	0.03	0.02	0.04	<u>0.03</u>	<u>0.04</u>	0.01	0.00	<u>0.01</u>	0.01	0.01	<u>0.03</u>
Loss Factor	0.98	0.95	0.97	<u>0.95</u>	<u>0.95</u>	0.97	<u>0.97</u>	<u>0.98</u>	0.96	0.97	<u>0.96</u>

(The selected offers are underlined)

In Area-B we assume that 9 providers, comprising 5 generators and 4 loads, are willing to provide secondary regulation services. Their corresponding bid parameters and those selected by the ISO are shown in Table 6.6.

Table 6.6 Secondary regulation bid in Area-B

Up Regulation	From Generators					From Customers			
Provider i	<u>1</u>	<u>2</u>	3	4	5	<u>7</u>	8	9	10
$\eta_{SR,i}^{UP}$ (\$/MWh)/MWh	<u>0.21</u>	<u>0.30</u>	0.40	0.34	0.40	<u>0.35</u>	<u>0.23</u>	0.33	0.23
$\gamma_{SR,i}^{UP}$ p.u.MW/(\$/MWh)	<u>0.03</u>	<u>0.04</u>	0.04	0.01	0.02	<u>0.01</u>	<u>0.02</u>	0.02	0.01
Loss Factor	<u>0.97</u>	<u>0.98</u>	0.96	0.95	0.97	<u>0.97</u>	<u>0.97</u>	0.96	0.96
Down Regulation	From Generators					From Customers			
Provider i	1	<u>2</u>	<u>3</u>	4	5	7	8	<u>9</u>	<u>10</u>
$\eta_{SR,i}^{DN}$ ((\$/MWh)/MWh)	0.05	<u>0.13</u>	<u>0.09</u>	0.07	0.07	0.03	0.03	<u>0.12</u>	<u>0.17</u>
$\gamma_{SR,i}^{DN}$ p.u.MW/(\$/MWh)	0.01	<u>0.04</u>	<u>0.03</u>	0.03	0.01	0.03	0.03	<u>0.03</u>	<u>0.01</u>
Loss Factor	0.97	<u>0.98</u>	<u>0.96</u>	0.95	0.97	0.97	0.97	<u>0.96</u>	<u>0.96</u>

(The selected offers are underlined)

The combined solution to the secondary regulation service market is given in Table 6.7.

Table 6.7 Market clearing of secondary regulation service

Area		Market Clearing Price \$/MWh	Quantity Cleared p.u.MW
A	Up Regulation	0.27	0.11
	Down Regulation	0.10	0.11
B	Up Regulation	0.33	0.095
	Down Regulation	0.09	0.095

6.3.3 System Performance with Primary and Secondary Regulation Services

The dynamic models shown in Figure 6.2 and Figure 6.5 are developed using small perturbation analysis of the system around a nominal operating point. The system can be represented using the state-space equations as

$$\frac{d\underline{x}(t)}{dt} = A\underline{x}(t) + \Gamma \underline{p} \quad (6.13)$$

In the above, $\underline{x}(t)$ is the state-vector comprising the system variables, \underline{p} is the perturbation. A and Γ are state and perturbation matrices of appropriate dimensions, respectively.

Now the selected sets of primary and secondary regulation service providers in two control areas are incorporated for the combined frequency regulation simulation. Two perturbations are considered in Area-A during a 150-seconds simulation period. The first is a 1% increase in load at time $t=0$ and the second is a 5% increase in load at time $t=12$ second.

6.3.3.1 Simulation Results of Primary Regulation

Figure 6.6 shows the plot of frequency as primary regulation services are activated. The system frequency settles to a new steady-state value with the primary regulation service. The primary regulation performances of the selected primary regulation providers, generators on bus 1,5,6,9, are plotted in Figure 6.7.

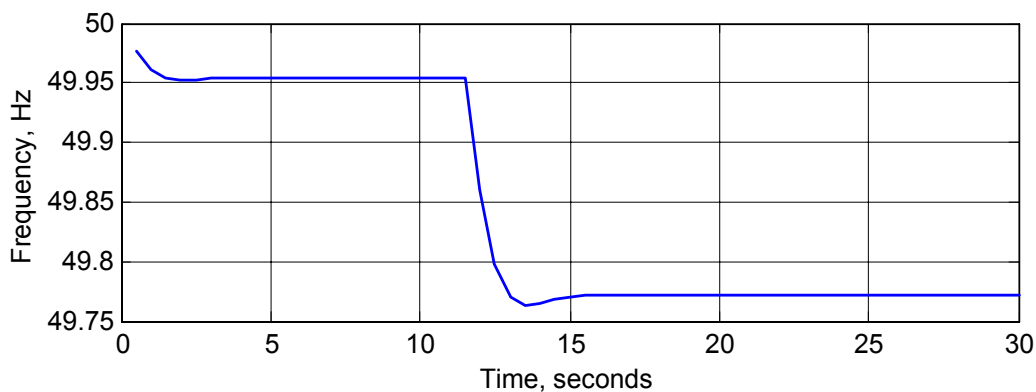

Figure 6.6 Area-A Frequency Plot with Primary Regulation

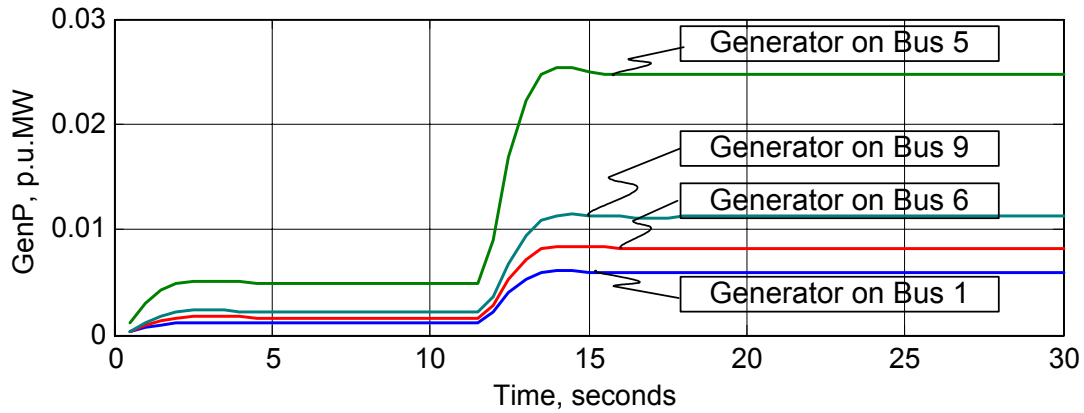

Figure 6.7 Area-A Primary Control Through Generators

6.3.3.2 Simulation Results of Primary and Secondary Regulation

Figure 6.8 shows the plot of the frequency following the two perturbations with primary and secondary regulation services activated. It is seen that the frequency is brought back to the nominal (50 Hz) through secondary regulation in about 2 minutes.

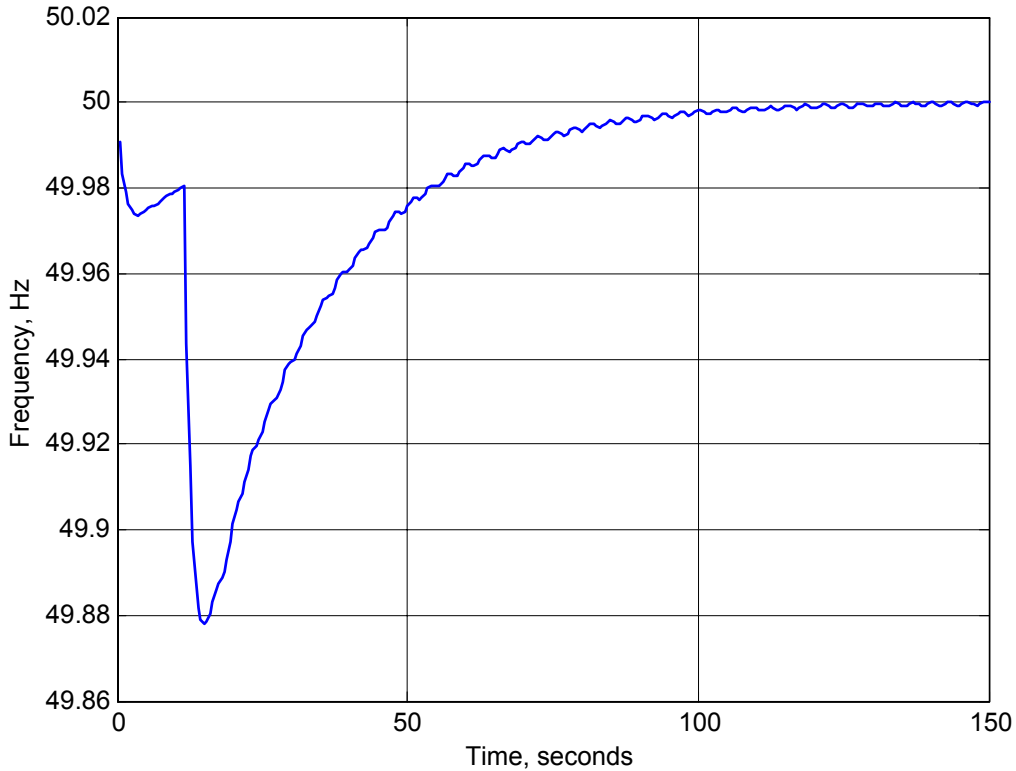

Figure 6.8 Area-A Frequency Plot With Primary and Secondary Regulation

Figure 6.9, Figure 6.10 and Figure 6.11 plot the generators' participation in the frequency control in Area-A. Figure 6.9 shows primary control responses of three generators that only provide primary regulation. Figure 6.10 shows the plot of the generator output that provides both primary and secondary regulation. Figure 6.11 shows the plot of the generator output that provides only secondary regulation.

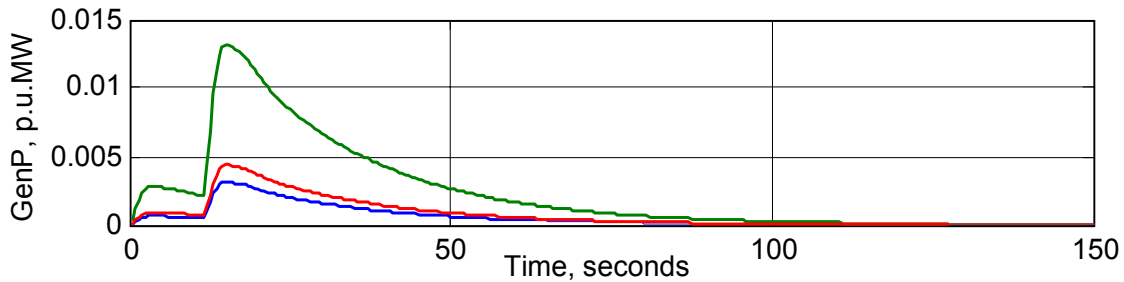

Figure 6.9 Area-A Primary Control Action from Generator 1-3

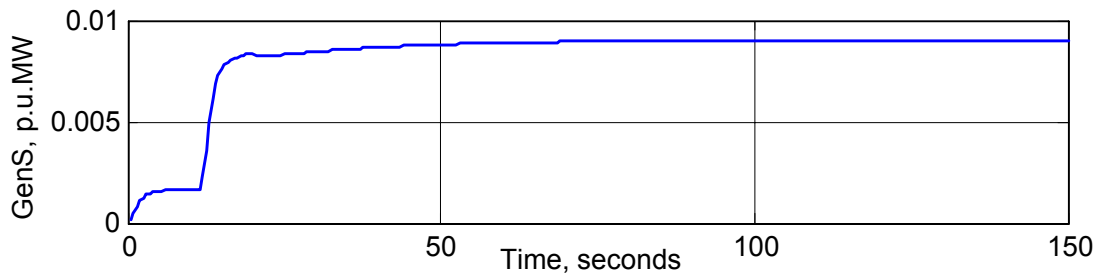

Figure 6.10 Area-A Primary and Secondary Control Action from Generator-4

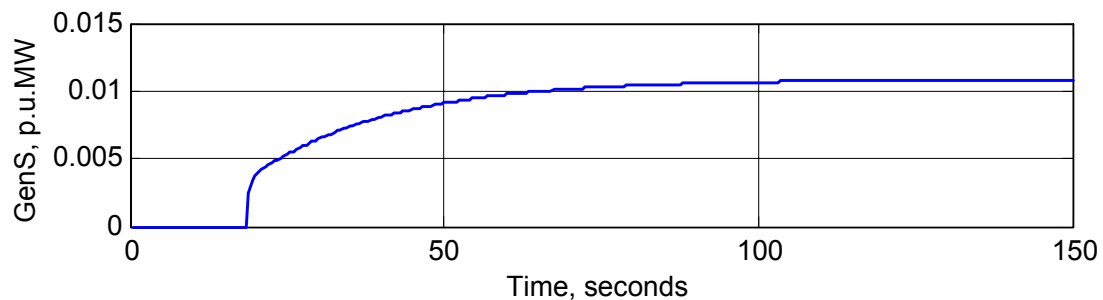

Figure 6.11 Area-A Secondary Control Only from Generator-5

6.4 CONCLUDING REMARKS

This chapter attempts to examine frequency regulation issues in the context of power sector deregulation. We propose a frequency-linked bidding structure for the frequency regulation service market. The participating parties are envisaged to respond to price signals sent out by the ISO, based

on their bid offers. An optimization scheme has been developed both for primary and secondary regulation services, to address the transmission system operator's problem of determining the best contracts. Further, a dynamic simulation model is developed for a two-area interconnected power system that incorporates the above features of frequency regulation services to examine the performance of the optimum regulation contracts.

CHAPTER 7

CONCLUSIONS

7.1 MAIN CONCLUSIONS AND CONTRIBUTIONS

This thesis attempts to examine the various issues involved in electric power ancillary services in the context of power sector deregulation. Particular emphasis is on the study of reactive power service, spinning reserve service and frequency regulation service, and how they are managed by the system operator in deregulated markets.

To this effect, a broad-ranging overview of ancillary service management in USA, Europe and Australia, has been presented. The issues pertaining to independent generators acting as reactive power providers in competitive markets have been brought out. We develop a reactive power market structure based on the analysis of reactive power costs from synchronous generators.

Subsequently, an offer price structure is incorporated with an OPF model and a two-step optimization procedure is used to determine the optimal reactive power contracts. The optimization scheme takes into account the marginal benefits from reactive power support at a system bus vis-à-vis the payment to be made by the ISO, by way of reactive power procurement.

Further, a competitive reactive power market is designed, and the issue is extended to voltage control areas. Uniform market prices for individual voltage control areas are obtained in the competitive market. Different gaming scenarios are simulated to examine the possibility of market power with contracted providers.

The thesis further examines the description of competitive market for spinning reserve services. Optimal contracting of spinning reserves has been discussed.

Subsequently, we propose a frequency-linked offer price structure for the frequency regulation service market. The participating parties are envisaged to respond to price signals sent out by the ISO, based on their offers. An optimization scheme has been developed, both for primary and secondary

regulation services, to address the ISO's problem of determining the best contracts. Further, a dynamic simulation model is developed for a two-area interconnected power system that incorporates the above features of frequency regulation services to examine the performance of the optimum regulation contracts.

7.2 SCOPE FOR FUTURE WORK

Research work on electric power ancillary services, in the context of electricity market deregulation, has been going on in many countries. The market structures differ, so do the structure of their ancillary service markets. Therefore, obtaining a conclusion and a universal market structure for these services is very difficult. There are tremendous scopes for work in this area since not much has yet been said on this topic.

Some of the important aspects and issues that need to be addressed in this area are the following:

- Broadening the scope of the ancillary service market to include a large section of providers. This could help reduce market power in certain cases, particularly for reactive power markets, by including capacity banks, SVCs, *etc.*
- Examine the possibility of attracting customers to this market and offering their services in this market, such as in the form of interruptible loads.
- With the entry of various distributed generation sources that inject energy into the grid at various sub-transmission voltage levels, issues of ancillary service management becomes more complex and need to be studied.
- Similarly, there is a need to examine how ancillary services are affected by the introduction of non-conventional energy sources, such as wind power, into the grid.

REFERENCES

- [1] K. Bhattacharya, M.H.J. Bollen and J. E. Daalder, *Operation of Restructured Power Systems*, Kluwer Power Electronics and Power Systems Series, Kluwer Academic Publisher, USA, 2001, ISBN 0-7923-7397-9.
- [2] M. Ilic, F. Galiana and L. Fink (Eds.), *Power Systems Restructuring: Engineering and Economics*, Kluwer Academic Publishers, 1998.
- [3] E. Hirst and B. Kirby, “Electric Power Ancillary Services”, Oak Ridge National Laboratory Technical Report, 1996, ORNL/CON-426.
- [4] New York Independent System Operator Ancillary Services Manual, 1999.
- [5] California ISO Corp., “Ancillary Services Requirement Protocol, FERC Electricity Tariff”, First Replacement Volume No. II, October 2000.
- [6] PJM Interconnection LLC, “Report to FERC on Ancillary service markets by the Market Monitoring Unit”, PJM Interconnection, April 2000.
- [7] PJM Interconnection LLC, “PJM open access transmission tariff: Schedule-2”, Fourth Revised, Vol.1, Issued Feb.2001.
- [8] The National Grid Company plc., “Ancillary Services – An Introduction”, Second Edition, 1995.
- [9] The National Grid Company plc., “An Introduction to Reactive Power: Ancillary Services- Reactive Contracts”, June 1998.
- [10] Svenska Krafnät, “OPF, constraints for reactive exchanges between the SvK 400-220 kV network and other networks in Sweden”, Internal paper.
- [11] K.Walve, “Frequency Control in the Nordic Power System: Experience and Requirements”, Proceedings of IEEE Power Engineering Society Winter Meeting 1999, pp. 559-560.
- [12] “FINGRID OY Main Grid Service Conditions 1”, January 1999.
- [13] National Electricity Market Management Company (Australia), “National electricity market ancillary services”, November 1999.

-
- [14] National Electricity Market Management Company (Australia), “Generator code reactive obligations”, November 1988.
- [15] National Electricity Market Management Company (Australia), “Ancillary Service Review – Recommendations”, October 1999.
- [16] Intelligent Energy Systems Pty Limited, “Evaluation of Options for an Ancillary Services Market for the Australian Electricity Industry”, August 1999.
- [17] B. Kirby and E. Hirst, “Ancillary services detail: Voltage control” Oak Ridge National Laboratory Technical Report, December 1997, ORNL/CON-453.
- [18] North American Electric Reliability Council, “White Paper- Draft of the Proposed Standards for Interconnected Operations Services”, ISO Task Force, NERC, June 1999.
- [19] North American Electric Reliability Council, “NERC Operating Policy-10 on Interconnected Operation Services”, Draft-3.1, February 2000.
- [20] R. Hirvonen, R. Beune, L. Mogridge, R. Martinez, K. Roudén and O. Vatshelle, “Is there a market for reactive power services- possibilities and problems”, CIGRÉ Paper 39-213, CIGRÉ Session 2000, Paris.
- [21] J. Zhong and K. Bhattacharya, Reactive power management in deregulated power systems- A review, Proceedings of IEEE Power Engineering Society Winter Meeting, Vol. 2, 2002, pp. 1287-1292.
- [22] S. Hao, A. Papalexopoulos, “Reactive power pricing and management”, *IEEE Transactions on Power Systems*, Feb. '97, pp. 95-104.
- [23] E. Fitzgerald, C. Kingsley Jr., S. D. Umans, *Electric Machinery*, McGraw-Hill, 1992.
- [24] J. W. Lamont and J. Fu, “Cost analysis of reactive power support”, *IEEE Transactions on Power Systems*, August 1999, pp. 890-898.
- [25] J. B. Gil, T. G. S. Roman, J. J. A. Rios, P. S. Martin, “Reactive power pricing: a conceptual framework for remuneration and charging procedures”, *IEEE Transactions on Power Systems*, May 2000, pp. 483-489.
- [26] GAMS Release 2.50, “A User’s Guide”, GAMS Development Corporation, 1999.

-
- [27] R. Ethier, R. Zimmerman, T. Mount, W. Schulze and R. Thomas, "A uniform price auction with locational price adjustments for competitive electricity markets", *Electric Power and Energy Systems*, Vol. 21, 1999, pp. 103-110.
- [28] G. Gross, D. J. Finlay, G. Deltas, "Strategic bidding in electricity generation supply markets", Proc. IEEE Power Engineering Society Winter Meeting, Vol. 1, 1999, pp. 309 -315.
- [29] M. Zelny, *Multiple criteria decision making*, McGraw Hill, 1992.
- [30] D. Chattopadhyay and J. Momoh, "A multiobjective operations planning model with unit commitment and transmission constraints", *IEEE Transactions on Power Systems*, Aug. '99, pp. 1078-1084.
- [31] "Generalized Algebraic Modeling Systems", www.gams.com.
- [32] R. Host, P. M. Pardalos, N. V. Thoai, *Introduction to Global Optimization*, 2nd Edition, Kluwer Academic Publishers, 2000.
- [33] D. Z. Du, P. M. Pardalos, W. Wu, *Mathematical Theory of Optimization*, Kluwer Academic Publishers, 2001.
- [34] B. A. Schlueter, S. Liu and K. Ben-Kilani, "Justification of the Voltage Stability Security Assessment and Diagnostic Procedure Using a Bifurcation Subsystem Method", *IEEE Transactions on Power Systems*, Vol. 15, No. 3, August 2000.
- [35] P.Lagonotte, J.C.Sabonnadiere, J.Y.Leost and J.P. Paul, "Structural Analysis of the Electrical System: Application to Secondary Voltage Control in France", *IEEE Transactions on Power Systems*, Vol. 4, No. 2, May 1989.
- [36] H. Liu, A. Bose and V. Venkatasubramanian, "A Fast Voltage Security Assessment Method Using Adaptive Bounding", *IEEE Transactions on Power Systems*, Vol.15, No.3, August 2000.
- [37] E. Nobile and A. Bose, "A New Scheme for Voltage Control in A Competitive Ancillary Service Market" Proceedings of 14th Power Systems Computation Conference, June 2002, Sevilla, Spain.
- [38] C. I. Cohen, V. Brandwajn and S. K. Chang, "Security constrained unit commitment for open markets", Proceedings of Power Industry Computer Applications Conference (PICA 99), pp. 39-44.
- [39] T. Alvey, D. Goodwin, X. Ma, D. Streiffert and D. Sun, "A security constrained bid clearing system for the New Zealand wholesale

- electricity market", *IEEE Transactions on Power Systems*, May '98, pp. 340-346.
- [40] New England Power Pool, "FERC Electric Rate Schedule No. 6, Market Rules & Procedures", Section 6 – Ten Minute Spinning Reserve Market, Effective May 2002.
- [41] M. Flynn, W. P. Sheridan, J. D. Dillon and M. J. O'Malley, "Reliability and reserve in competitive market scheduling", *IEEE Transactions on Power Systems*, Vol. 16, No. 1, Feb. 01, pp. 78-87.
- [42] M. Madrigal and V. H. Quintana, "A security-constrained energy and spinning reserve markets clearing system using an interior-point method", *IEEE Transactions on Power Systems*, Vol. 15, No. 4, Nov. '00, pp. 1410- 1416.
- [43] S. Halilcevic, "Procedures for Definition of Generation Ready-Reserve Capacity", *IEEE Transactions on Power Systems*, Vol. 13, No.2, May 1998.
- [44] S. Halilcevic and F. Gubina, "Optimal Space Distribution of Generation Ready-Reserve Capacity", *IEEE Transactions on Power Systems*, Vol. 14, No. 4, November 1999.
- [45] S. Halilcevic and F. Gubina, "An On-line Determination of the Ready Reserve Power", *IEEE Transactions on Power Systems*, Vol. 14, No. 4, November 1999.
- [46] G. S. Maddala, *Introduction to Econometrics*, 3rd Edition, John Wiley & Sons, 2001.
- [47] R. D. Christie and A. Bose, "Load Frequency Control Issues in Power System Operations After Deregulation", *IEEE Transactions on Power Systems*, Vol. 11, No. 3, August 1996, pp.1191-1200.
- [48] E. Nobile, A. Bose and K. Tomsovic, "Feasibility of a Bilateral Market for Load Following", *IEEE Transactions on Power Systems*, Vol.16, No.4, November, 2001, pp 782-787.
- [49] J. Kumar, Kah-Hoe Ng and G. Sheblé, "AGC Simulator for Price-Based Operation- Part I: Model", *IEEE Transactions on Power Systems*, Vol.12, No.2, May 1997, pp.527-532.
- [50] J. Kumar, Kah-Hoe Ng and G. Sheblé, "AGC Simulator for Price-Based Operation- Part II: Case Study Results", *IEEE Transactions on Power Systems*, Vol.12, No.2, May 1997, pp.533-538.

- [51] Svenska Kraftnät, *The Swedish Electricity Market and the Role of Svenska Kraftnät*, Second Edition, 1997 (available from www.svk.se)
- [52] Svenska Kraftnät, *Balance obligation agreement 2001* (available from www.svk.se)
- [53] A. W. Berger and F. C. Schweppe, "Real-time pricing to assist in load frequency control", *IEEE Transactions on Power Systems*, Vol.4, August 1989, pp.920-926.
- [54] K. Bhattacharya, D. Chattopadhyay and J. Parikh, "Real-time adaptive pricing for load frequency control in an interconnected power system", *International Journal of Power and Energy Systems*, Vol.18, 1998, pp.102-109.
- [55] K. Walve, "Nordic 32-A CIGRÉ Test System for simulation of transient stability and long term dynamics", Svenska Kraftnat, Sweden, 1993.
- [56] C. W. Taylor, *Power System Voltage Stability*, McGraw Hill, 1994.

APPENDICES

Appendix-A CIGRÉ 32-BUS SYSTEM

The Cigré 32-bus test system [55], shown in Figure A.1, has been used in this thesis to evaluate the various ancillary service procurement plans for the ISO. The system consists of four major areas:

- North:* with basically hydro generation and some load.
- Central:* with a large amount of load and rather large thermal power generation.
- Southwest:* with a few thermal units and some load.
- External:* connected to the *North*. It has a mix of generation and load.

The main power transfer is from “north” to “central”. The “external” system consists of a very simplified network. The main transmission system is designed for 400 kV. There are also some regional systems at 130kV and 220kV. The number of buses at 400kV, 220kV and 130kV are 19, 2 and 11 respectively. In the Cigré test system, there are 19 generators, 1 synchronous condenser, 10 shunt capacitors and 2 inductors. The data of generators and shunts is given in Table A.1. Bus 4011 is selected as the slack bus.

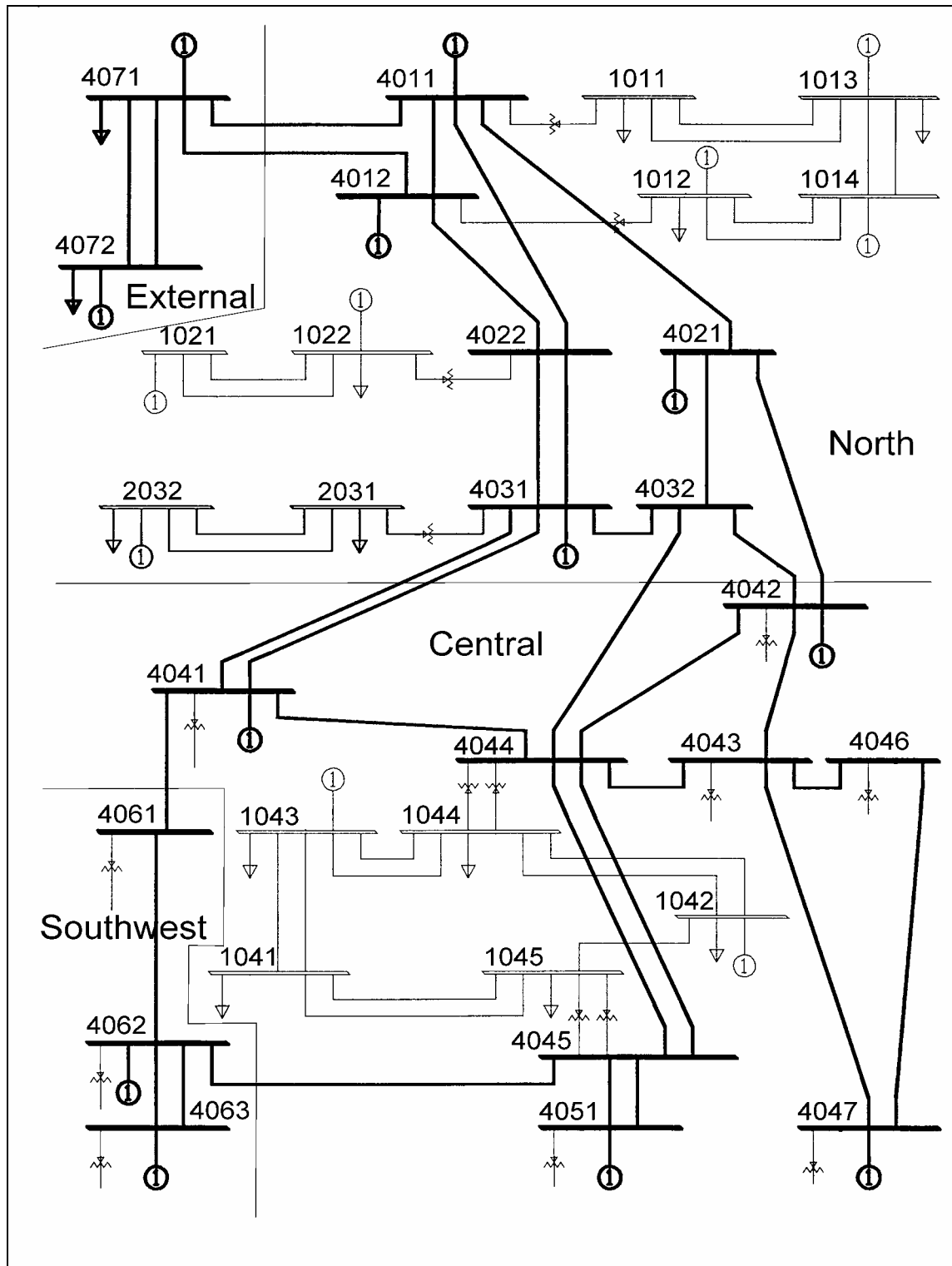

Figure A.1 Cigré 32-bus Test System Network Configuration

Table A.1 Data of generators and capacitors for Cigré 32-bus system

Bus no.	Pmax (MW)	Qmax (MVA _r)	Qmin (MVA _r)	Qsh (MVA _r)
4072	4500	1500	-750	0
4071	500	167	-84	-400
4011	1000	333	-167	0
4012	800	267	-133	-100
4021	300	100	-50	0
4031	350	117	-59	0
4042	700	233	0	0
4041	0	300	-200	200
4062	600	200	0	0
4063	1200	400	0	0
4051	700	233	0	100
4047	1200	400	0	0
2032	850	283	-142	0
1013	600	200	-100	0
1012	800	267	-133	0
1014	700	233	-117	0
1022	250	134	-67	50
1021	600	200	-100	0
1043	200	67	0	150
1042	400	133	0	0
2031				100
1011				200
1041				600
1044				800
1045				700

Appendix-B MODELING BILATERAL CONTRACTS

In bilateral markets, the energy sell/buy contracts (bilateral contracts) between independent generators and customers are assumed to have been signed in advance. In order to appropriately represent such power transactions, a bilateral transaction matrix ‘XP’, representing all combinations of trades between participating parties, is created. In this appendix, we discuss the modeling of the bilateral transactions in details. The model is based on the following features:

- All contracts between generators and customers are represented using random numbers.
- The random numbers associated with all contracts have the same probability.
- The sum of all contracts entered into, by one customer, equals the total demand of the said customer.
- The sum of all contract entered into by one generator, equals the contracted generation of the said generator.

The bilateral contracted transactions between a generator ‘gen’ and a customer ‘dem’ at a bus are modeled as following steps:

- 1) The demand of each bus ‘dem’ is given as Pd_{dem} .
- 2) Set a uniformly distributed random number RPg_{gen} for each generator bus in the range $(0.8 \cdot Pmax_{gen}, Pmax_{gen})$, where $Pmax_{gen}$ is the upper limit of the generation at bus ‘gen’. To match the total generation and total demand, the contracted generation, Pg_{gen}^{con} , for each generator is

set as
$$Pg_{gen}^{con} = \frac{RPg_{gen}}{\sum_{gen} RPg_{gen}} \times \sum_{dem} Pd_{dem}$$
. So the sum of all Pg_{gen}^{con} is the

same as the sum of all Pd_{dem} .

- 3) Set a uniformly distributed random number $RTr_{dem,gen}$ for each contracts between generator ‘gen’ and customer at bus ‘dem’ in the range $(0, LF \times Pg_{gen}^{con})$, where LF is loss factor.
- 4) Scale the random number $RTr_{dem,gen}$ to match the demand on each load bus. We get a set of preliminary contract value:

$$Tr_{dem,gen} = \frac{RTr_{dem,gen}}{\sum_{gen} RTr_{dem,gen}} \times Pd_{dem}$$

5) The final bilateral contracted exchange power, $XP_{dem,gen}^{con}$, are given by equation (B.1).

$$XP_{dem,gen}^{con} = Tr_{dem,gen} + \left(Pg_{gen}^{con} - \sum_{dem} Tr_{dem,gen} \right) \times \frac{Tr_{dem,gen}}{\sum_{dem} Tr_{dem,gen}} \quad (B.1)$$

We can prove that these random bilateral transactions satisfy two rules: a) the sum of all contracts with one customer at load bus ‘dem’ equal to the demand Pd_{dem} . b) the sum of all contracts with one generator at bus ‘gen’ equal to Pg_{gen}^{con} .